



BC HOUSING

# Design Guidelines and Construction Standards

2019



BRITISH  
COLUMBIA



BC HOUSING

# Table of Contents

## INTRODUCTION

## GLOSSARY OF TERMS

## SECTION 1 GENERAL DESIGN GUIDELINES

General

Site Investigation

Building Design Principles

Building Common Areas

Dwelling Unit Design

Kitchens and Bathrooms

Finishes and Materials

Wheelchair Accessible and Adaptable Dwelling Units

Building Systems

Landscape Design

## SECTION 2 ENERGY AND ENVIRONMENTAL DESIGN

Sustainability Goals

Building and Energy Performance Targets

Passive Design Strategies

Energy Efficient Products, Incentives and Energy Assessment

Construction, Renovation and Demolition Waste Management

Water Efficient Design

Building Material Selection

Sustainable Site Management

Technical Bulletin No.1-2020

[https://www.bchousing.org/  
partner-services/asset-  
management-redevelopment/  
construction-standards](https://www.bchousing.org/partner-services/asset-management-redevelopment/construction-standards)

## SECTION 3 CRIME PREVENTION THROUGH ENVIRONMENTAL DESIGN

Description

CPTED Principles

CPTED Performance Objectives

CPTED Performance Standard Checklist

## SECTION 4 CONSTRUCTION STANDARDS

### Introduction to Construction Standards

#### Division 1 - General Requirements

01 23 00 - Alternatives

01 31 00 - Project Meetings

01 45 00 - Quality Control

01 74 19 - Construction Waste Management and Disposal

01 78 00 - Closeout Submittals

01 91 00 - Commissioning

#### Division 2 - Existing Conditions

02 30 00 - Subsurface Investigation

#### Division 3 - Concrete

03 30 00 - Cast-in Place Concrete

**Division 4 - Masonry**

[04 20 00 - Masonry](#)

**Division 5 - Metals**

[05 50 00 - Metal Fabrications](#)

**Division 6 - Wood and Plastics**

[06 10 00 - Rough Carpentry](#)

[06 20 00 - Finish Carpentry](#)

**Division 7 - Thermal and Moisture Protection**

[07 05 00 - Thermal Bridging & Airtightness](#)

[07 10 00 - Dampproofing and Waterproofing](#)

[07 21 00 - Thermal Protection](#)

[07 31 13 - Asphalt Shingles](#)

[07 46 16 - Metal Siding](#)

[07 46 33 - Vinyl Siding](#)

[07 46 46 - Fiber-Cement Siding](#)

[07 50 00 - Membrane Roofing](#)

[07 72 00 - Roof Accessories](#)

[07 80 00 - Firestopping and Smoke Seals](#)

[07 92 00 - Joint Sealants](#)

**Division 8 - Doors and Windows**

[08 11 00 - Metal Doors & Frames](#)

[08 14 00 - Wood Doors & Frames](#)

[08 33 23 - Overhead Parkade Doors](#)

[08 41 00 - Aluminum Entrances & Storefronts](#)

[08 50 00 - Windows, Side Hinged & Sliding Glass Doors](#)

[08 70 00 - Finish Hardware](#)

**Division 9 - Finishes**

[09 24 23 - Stucco](#)

[09 28 00 - Gypsum Wallboard](#)

[09 30 00 - Ceramic Tile](#)

[09 65 00 - Resilient Flooring](#)

[09 68 00 - Carpet](#)

[09 91 00 - Painting](#)

**Division 10 - Specialities**

[10 00 00 - Specialities](#)

[10 28 19 - Plastic Laminate Tub Enclosure](#)

**Division 11 - Equipment**

[11 30 00 - Equipment](#)

**Division 12 - Furnishings**

[12 20 00 - Window Treatment](#)

[12 32 00 - Manufactured Wood Casework](#)

**Division 13 - Special Construction**

[13 20 00 - Heat Treatment Room](#)

**Division 14 - Conveying Systems**

[14 20 00 - Elevators](#)

**Division 21 - Fire Protection**[21 00 00 - Fire Protection](#)**Division 22 - Plumbing**[22 00 00 - Plumbing](#)**Division 23 - Mechanical**[23 00 00 - Heating, Ventilation and Air Conditioning](#)**Division 26 - Electrical**[26 00 00 - Electrical](#)**Division 27 - Communications**[27 00 00 - Communications](#)**Division 31 - Earthwork**[31 23 00 - Excavation and Backfill](#)**Division 32 - Exterior Improvements**[32 12 16 - Asphalt](#)[32 90 00 - Planting](#)**SECTION 5 DRAWING AND DOCUMENT REQUIREMENTS**[Schematic Design Phase](#)[Design Development Phase](#)[Construction Document Phase](#)**APPENDIX A HAZARDOUS MATERIAL GENERAL INFORMATION**[Hazardous Material General Information](#)[WorkSafeBC Regulations](#)[Potential Locations for Asbestos Materials](#)[Owner and Employer Requirements](#)[Disturbing Hazardous Materials](#)[Additional Consideration](#)**APPENDIX B REDUCING AIR LEAKAGE BETWEEN SUITES**[Background](#)[Typical Air Leakage Areas](#)[Approach and Air Sealing Details](#)[References](#)**APPENDIX C HVAC STRATEGIES FOR BC HOUSING PROJECTS**[General](#)[Recommendations for Acceptable HVAC Systems](#)**APPENDIX D MODULAR CONSTRUCTION METHODS**[Background](#)[Modular Design Requirements](#)[Modular Fabrication And Installation](#)[Finishes and Furnishing](#)[BC Housing Approval Process](#)[BC Housing Inspection and Commissioning](#)

# Introduction

The *BC Housing Design and Construction Standards* provide standards and technical guidelines for the design and construction of new buildings, conversions and renovation projects funded and financed by BC Housing. This document is intended to be a reference and baseline from which full project specifications are to be developed by the Design Team.

The goals of the BC Housing Design and Construction Standards are:

1. provide safe and secure housing that responds to needs of the residents and fosters a sense of community
2. design projects that are cost effective, spatially efficient, easy to maintain
3. pursue sustainable design and construction practices that balance environmental responsibility, the well-being of the users and efficient use of resources while considering economics of building construction and life cycle costs
4. construct buildings which are durable and meet BC Housing's life expectancy for the building structure and considers the service life of all building components from the perspective of life cycle costs and long-term operational efficiency
5. optimize project outcomes relating to user satisfaction, timelines, and cost through a design approach which considers the needs of all stakeholders in an integrated manner throughout the project development cycle

The *BC Housing Design Guidelines and Construction Standards* are currently organized into five sections:

- 1. General Design Requirements** – provides the site planning and building design requirements, primarily applicable to the Schematic design and Design Development stages.
- 2. Energy and Environment Design** – provides design guidelines to ensure projects are designed to meet BC Housing sustainability goals, greenhouse gas neutral strategies and energy requirements.
- 3. Crime Prevention through Environment Design** – summarizes the strategies used to influence environmental design decisions that will be incorporated to deter criminal behavior and nuisance activities.
- 4. Construction Standards** – outlines the minimum requirements or referenced standards that must be incorporated in the construction documents. This section is primarily applicable to the project specifications.
- 5. Drawing and Document Requirements** – identifies the level of detail required for drawings and specifications for each stage of the BC Housing project review process.

## ALTERNATIVES TO THE BC HOUSING DESIGN GUIDELINES AND CONSTRUCTION STANDARDS

If there are any conflicts or discrepancies within the BC Housing Design Guidelines and Construction Standards, please contact BC Housing for clarification.

The purpose of this document is to establish an acceptable level of quality for construction materials and assemblies that optimizes occupant satisfaction and minimizes annual operating costs for the building.

In this context, BC Housing recognizes the responsibility and authority of the Prime Consultant with respect to the preparation of the construction contract documents and the expertise that the non-profit societies, and other operators, will bring to the projects being developed or renovated. For these reasons, BC Housing will support proposals for alternatives to these standards from non-profit societies, or others, and their development teams.

# Glossary of Terms

**Assisted Living:** Assisted living units are self-contained apartments for seniors or people with disabilities who need some support services to continue living independently, but do not need 24-hour facility care. Services provided include daily meals, social and recreational opportunities, assistance with medications, mobility and other care needs, a 24-hour response system and light housekeeping.

**At-risk:** clients/tenants who are at risk of losing their accommodation or becoming homeless.

**Commissioning (Cx) Plan:** Document that outlines and specifies the commissioning processes, roles and responsibilities, resources required, schedule and sequence, for new or renovated building projects and systems.

**Commissioning Provider (CxP):** The entity identified by the Owner or BC Housing who leads, plans, schedules and coordinates the commissioning team to implement the commissioning process. This is an independent 3rd party personnel working under a separate contract directly with the Owner or BC Housing.

**Contractor's Commissioning Agent (CxAg):** Individuals, each having authority to act and report on behalf of the entity they represent, explicitly organized to implement the commissioning tasks required for within their respective contracts (such as mechanical, electrical, etc. ) and aiding in the overall Cx process through coordinated actions, within the Cx Team.

**Family Housing:** Independent housing for low to moderate income households with a minimum of two people including at least one dependent child.

**Group Home:** A small, community-based development, usually under 10 beds/units, that provides affordable housing with supports to those with special needs including individuals with severe mental and physical disabilities, youth, and women with their children fleeing abuse. BC Housing provides administration and property management support for group homes on behalf of other provincial ministries and health authorities.

**Independent Seniors:** Housing for seniors where minimal or no additional services are provided. Seniors are usually defined as individuals who are 65 years of age and older.

**Owner's Project Requirements (OPR):** A stand-alone document that details the functional requirements of the building systems installed as part of the project. The OPR document is critical to the Commissioning Process because it forms the foundation for the design, construction, and occupancy and operation of the facility and is the standard that will be used for verification. The Owner will create the OPR at conceptual design stage and the document may evolve as decisions are made to reflect the current project requirements of the Owner.

**PRHC:** The Provincial Rental Housing Corporation is BC Housing's land-holding company. It holds provincially owned social housing properties, and leases residential properties to non-profit societies and co-operatives.

**Second Stage Housing:** Housing for women and children at risk of violence who have completed a stay in a transition house or safe home. Stays can be up to 18 months.

**Self-contained Housing:** A dwelling unit that includes a kitchen, bathroom, living, sleeping, and dining area within the unit.

**Single Room Occupancy (SRO):** These provide long-term accommodation in single rooms, typically without private bathrooms or kitchens.

**Social Housing:** Includes both public housing and housing that is owned and managed by non-profit and co-operative housing providers.

**Supportive Housing:** Housing that provides ongoing supports and services to residents who cannot live independently and are not expected to become fully self-sufficient.

**Transitional Housing:** Housing that is provided for a minimum of 30 days and up to two or three years, which includes the provision of on- or off-site support services to help people move towards independence and self-sufficiency.

section

# General Design Guidelines

- 
- General
  - Site Investigation
  - Building Design Principles
  - Building Common Areas
  - Dwelling Unit Design
  - Kitchens and Bathrooms
  - Finishes and Materials
  - Wheelchair Accessible and Adaptable Dwelling Units
  - Building Systems
  - Landscape Design

# 1 General

## 1.1 OBJECTIVES

- .1 The BC Housing Design Guidelines and Construction Standards provide basic guidance on design and performance which will influence the form, layout and specifications of buildings delivered under the various programs of BC Housing. The Guidelines are intended to assist the Project Team to design and develop safe, affordable, stable and sustainable housing.
- .2 The BC Housing Design Guidelines are a combination of performance guidelines and prescriptive standards. Project teams should use these guidelines and standards to prepare a design program that reflects the Owner's specific requirements, the characteristics and opportunities presented by the building site, and the framework of the funding program under which the project is being delivered.
- .3 In all cases, project design is expected to comply with the requirements of federal, provincial, municipal governments, and all authorities having jurisdiction over the project.
- .4 Buildings are expected to achieve a high level of energy efficiency and sustainability using a building envelope first design approach and passive design strategies.

## 1.2 APPLICABILITY OF THE GUIDELINES

- .1 Unless otherwise specified in this document, the recommendations included in these guidelines are intended to apply to housing developments whose capital and/or operating budgets are funded or financed by BC Housing regardless of project type.
- .2 For renovation/capital improvement or conversion projects, it is recognized that existing conditions or user considerations may override the recommendations contained in these Guidelines. If such is the case, approval from BC Housing should be obtained at the schematic or preliminary design stage.

## 1.3 PROJECT TYPES

Projects delivered under the various housing programs of BC Housing are generally classified as new construction, renovation/ capital improvement or conversion projects.

### .1 New Construction Projects

New construction projects are designed primarily as residential in occupancy but may also include secondary uses associated with support services provided to the residents. Some developments may also include commercial or leased spaces.

The scope, size and target clients for a project should be based on a need and demand analysis for a particular location or region and should be designed to meet the needs of the clients within the cost and funding framework established for the project. Analyzing the number of subsidized housing units in the community or within the regional district, average rents and rental vacancies should also be considered for understanding market conditions.

### .2 Renovation/Capital Improvement Projects

Renovation/capital projects involve major or minor capital improvements or changes in the

design, layout, materials or systems of an existing building which do not typically involve a change of use or building occupancy.

BC Housing has developed a provincially-based capital planning process that includes assessments of buildings to determine the required capital renewal needs. All renovation/capital improvement projects that are initiated have been identified as high priority on the provincial priority list and are undertaken based on a full analysis of Facility Condition Index (FCI), service life and impact to residents.

### **.3 Conversion Projects**

Conversion projects involve a change in building use and occupancy. A rezoning process may be required to meet new occupancy requirements. A zoning bylaw and building code review as part of an overall project feasibility study should be undertaken to determine the extent of any changes or retrofits to the building arising from the change in use.

## **1.4 MAIN HOUSING CLIENT GROUPS**

The following are the client groups for which these design guidelines are intended:

- Homeless or Persons at Risk
- Low Income Families
- Youth
- Seniors (independent seniors and assisted living)
- Persons with physical disabilities and mental health conditions
- Indigenous people
- Women and children at risk of violence

## **1.5 BUILDING FORM**

- .1** Housing provided under BC Housing programs may take the following building forms:
  - Emergency shelters
  - Transition/second stage housing
  - Medium-density housing such as townhouses and motel-type accommodations.
  - Low-rise apartment buildings
  - High-density housing such as medium to high-rise apartment buildings
  - Licensed group homes or licensed residential care facilities
- .2** Subject to BC Housing approval, other housing forms may be considered depending on the specific needs of the client group and location of the project.
- .3** BC Housing has developed design guidelines for [Emergency Shelters](#) and [Women's Transition/Second Stage Housing](#) that are available at the BC Housing website. These documents shall be used as a reference in the design of these buildings. The building design and layout for vulnerable client groups with self-contained units as well 24-hour staffing support to the occupants are outlined in this section.

## 1.6 CONSTRUCTION METHODS

- .1 For new buildings up to six storeys in height, wood frame construction should be the standard form of construction. The Wood First Act of BC requires provincially funded projects to use wood as the primary construction material.
- .2 Where required by Code or determined to be more cost effective, concrete or structural steel framing can be considered.
- .3 Alternative forms of construction, such as modular pre-manufactured or panelized systems could be considered to improve the cost-efficiency, and reduce construction timelines of a project. For additional construction standards and information for modular construction, please refer to [Appendix D Modular Construction Methods](#)
- .4 A proposal for an alternative construction method shall be submitted at the schematic stage of the project and must take into consideration the life cycle cost of the system as well as the local skills available for the maintenance and future upgrades to the building.

Refer to [Construction Standards, Division 01 23 00 Alternatives](#).

## 1.7 DESIGN SERVICE LIFE

### New Construction

The target design service life for BC Housing buildings, based on CSA S478 Guideline on Durability in Buildings, are as follows:

**Long Life category - 60 Years.** This is the category that most BC Housing funded projects fall under. The BC Housing Design Guidelines and Construction Standards are intended to address this target design service life.

**Permanent Building category - 100 Years.** If this is the intended service life of the building, consult BC Housing as additional requirements beyond these guidelines may apply.

### Renovations

For renovation projects, any variances from the target service life of components and assemblies will be defined by the Owners Project Requirements provided by the BC Housing project representative. The target design service life should also consider the broader plans for development or re-development of the project site.

If the target design service life is 60 years and over, then BC Housing Design Guidelines will apply.

## 1.8 DESIGN PROCESS

To facilitate successful project development, it is important that the project team be engaged at the start of a project to work collaboratively to meet the **Owner's Project Requirements (OPR)** and budget. Refer to [BC Housing Building Commissioning Guidelines](#) for OPR requirements. An integrated approach to building design seeks to attain high performance on a wide variety of specific environmental and social goals while staying within budgetary and scheduling limitations. The specific phases associated with the process are directly related to the project's design intent.

In addition to extensive collaboration, integrated design involves a "whole building design" approach as opposed to an accumulation of separate components (site, structure, systems, and

use). The goal of looking at all systems together is to make sure that they all work in harmony with each other. An effective integrated design approach can ensure that the project team incorporates the needs of the Owner based on their concerns, function, and operational requirements. Also, this kind of process can ensure information is shared on daily operations such as who will be performing regular maintenance and what their level of expertise is and what training will be required. This process also minimizes costs as changes that are needed can be addressed earlier in the development process.

An integrated design approach is a BC Housing requirement for all new projects, and should be considered on other projects such as conversions, renovations/capital improvements, or small scale projects.

### **PRE-DESIGN**

The earliest stages of design represent an opportunity to set goals, objectives and the overall direction for a project. The **Owner/Operator** outlines the requirements and their concerns and ensures that the design team understands their needs and wishes for the project.

### **SCHEMATIC DESIGN**

In the Schematic Design phase the project teams investigate options and innovative solutions that will help the project to optimize the design for the site and meet operational needs within the project budget. Evaluation of options should be as holistic and life-cycle based as possible, taking into account the particulars of the opportunities especially the passive design strategies and constraints unique to the project.

### **DESIGN DEVELOPMENT**

The project team shall select the optimum option, finalize the design, and establish the construction budget. Final analysis of options should be conducted with input from the whole project team and presented to the Owner and BC Housing for approval.

### **CONSTRUCTION DOCUMENTATION**

The project team shall ensure that the concerns raised during earlier phases are addressed in detail in the construction documents. The Owner shall review the documents with the team to confirm that the integration achieved earlier is maintained, within budget and schedule constraints.

### **BIDDING, CONSTRUCTION AND COMMISSIONING**

The design team shall make sure that knowledge and information about both the goals of the project team and the operating requirements of the building must be passed from design team to the construction team to the operating team. Effective communication through regular site meetings, drawing reviews, site inspections/reports, proper scheduling, qualified workmanship, commissioning and training shall be integral part in this phase.

### **POST CONSTRUCTION**

The design and construction team ensures that deficiency items follow up, closeout documentations, commissioning activities and building handover tasks are taken into account. All project team members bear some responsibility for these activities.

## POST OCCUPANCY

Once the building is occupied and complete, integration and the process are still continued through the maintenance and operation activities. The owner/operator shall ensure all equipment and systems are commissioned, keep a summary of the systems those are meeting their performance as intended and those that do not meet performance, and list all issues resolved and unresolved. The owner/operator shall ensure greater and more effective feedback are provided to the design and construction teams during the warranty period. Lessons learned are passed on to BC Housing and development teams to ensure continuous improvement of processes and standards.

# 2 Site Investigation

## 2.1 SITE CONSIDERATIONS – DUE DILLIGENCE

### .1 Access to existing community services and infrastructure

Sites for new housing developments should be located in areas which have access to existing infrastructure, public transportation and community services.

### .2 Zoning and Development Analysis

Each municipality in BC has their own regulations governing development. A careful analysis of the development regulations must be undertaken by the project team to determine allowable density, height, site coverage, parking requirements, bicycle requirements and energy targets. Early contact with the municipality is required.

### .3 District Energy Systems (DES)

Sites that have access to available or planned district energy systems shall evaluate the feasibility of connecting to these systems in accordance with the local municipal by-laws and requirements of the DES utility provider.

### .4 Soils and subsurface conditions

Due diligence must be undertaken in assessing existing soil and geotechnical conditions to ensure these are suitable for the proposed development, building location at site and that there are no conditions which could significantly impact the viability of the project. A **geotechnical engineer** must be engaged to coordinate subsurface investigation and prepare a **geotechnical report**. Any risk associated with future increased water level should also be taken into consideration.

### .5 Environmental site assessment

- .1 Potentially hazardous conditions affecting the site must be reviewed to assess the risks and the mitigating measures necessary to manage these risks. These include contaminated soils, hazardous materials, flooding, steep slopes and other potential physical and environmental hazards. Risks associated with climate change such as future increased temperatures and increased severity of high winds, fire and flooding should also be taken into consideration.
- .2 A comprehensive review of any hazardous materials at the site must be completed. Any work undertaken that disturbs the materials must be completed in a way that reduces the disruption and should be done within the appropriate safety requirements. For existing

buildings to be renovated or demolished an environmental consultant should be engaged to identify hazardous materials and advise on methods of remediation and removal.

- .3 In sensitive environmental areas (adjacent to waterways, wetlands, flood plains, etc.) an environmental consultant should be engaged to evaluate the potential environmental impacts of the planned construction and prepare an Environmental Impact Assessment (EIA).
- .4 BC Housing requires a Phase 1 Environmental Site Assessment for all new construction sites to obtain development approval. This assessment will identify any potential areas of environmental concern within a subject property by reviewing historical usage of the site. If it indicates significant environmental concerns, further study will be required.
- .5 For renovation projects or buildings for purchase, consider undertaking radon testing.

## .6 Survey

- .1 A site survey should be undertaken to determine any **right of ways, encroachments** or legal encumbrances. This should be combined with a topographic survey which determines site boundaries, locates existing trees, services, adjacent structures, identifies floodplains, top of banks, nearest fire hydrant, etc.

## .7 Arborist

- .1 If significant trees are identified in the site survey and they are to be retained, an arborist should be engaged to propose preservation and mitigation strategies. Review municipal requirements for tree retention and replacement.
- .2 Where applicable, especially in rural areas, review site and adjacent areas to determine a prudent approach for site planning and landscaping to minimize interface fire risks.

## .8 Acoustic considerations

Where existing or potential road, rail or other sources of noise indicate a need for review, an acoustic consultant should be engaged to prepare an **acoustic report**, to recommend mitigation measures and confirm municipal bylaw requirements are met. Ensure that the recommendations are incorporated into the **construction documents**.

## .9 Heritage Designation

For areas or buildings with a heritage designation or classification or archaeologically sensitive, the requirements of the local, provincial or federal heritage authority should be reviewed and evaluated at the feasibility stage of the project. If a heritage building is on the property, a heritage consultant should be engaged to undertake a study of the structure and prepare a Statement of Significance (SoS).

## 2.2 SITE PLANNING PRINCIPLES

### .1 General

- .1 A careful analysis of the site should be undertaken to determine the best location for the building on the site. Factors such as topography, existing vegetation, site drainage, vehicular access, pedestrian access, fire truck access, location of services, required setbacks, relationship to neighbouring buildings, and solar orientation must all be taken into consideration.

- .2 An accessible route shall be provided from the main street to the building and to all exterior areas intended for tenant use including landscaped open spaces and outdoor recreation areas.
- .3 Building orientation shall be **optimized** as noted in Section 3 under Recommended Passive Design Strategies to reduce life-cycle costs and increase **user** thermal comfort.
- .4 Site planning and landscape design should consider basic defensible space principles to promote tenant security. Project design shall take into consideration Crime Prevention Through Environmental Design (CPTED) strategies, e.g., territoriality, natural surveillance, activity support and access control as well as other recognized CPTED principles. Refer to [Crime Prevention Through Environmental Design \(CPTED\)](#).

## 3 Building Design Principles

### 3.1 BUILDING DESIGN CONSIDERATIONS

- .1 Provide a building that is spatially efficient and designed to maximize the ratio of residential areas to required programme, support, circulation and service areas. Standardize unit types, kitchen and bathroom layouts within a project as much as possible. Co-ordinate and plan for amenity and support service spaces to maximize efficiency of circulation for both tenants and staff. The amenities should be located centrally and grouped for efficiency and to encourage social interaction. The project team shall avoid unnecessary amenity spaces and consider the use of multi-use amenity spaces. Refer to **Cost Target Framework** article below.
- .2 Building configuration, building size and building envelope will be the most critical components informing the efficiency and sustainability of the project. Buildings should be simple, efficient and easy to build. Avoid numerous small projections or recesses. Keep the foundation plan simple. Maintain continuity of load bearing walls between floors.
- .3 Provide building forms and design that integrate the use of passive energy and sustainable design principles. Optimize envelope design, building massing and orientation, low-demand fixtures, use of renewable sources of energy to reduce demand on fossil-fuel based energy, and reduce greenhouse gas emissions. Consider external shading for south and west facing windows **and low solar heat gain coefficient**. Landscape with natural and drought resilient vegetation.

Refer to [Energy and Environmental Design](#) section.

- .4 Provide building materials and finishes that are durable and require low maintenance. Consider the requirements of the users, availability of maintenance products, and overall life cycle costs.
- .5 In addition to addressing sustainability concerns, design the building envelope to current code and industry best practices to prevent water penetration and envelope failure.

Refer to the [BC Housing Building Enclosure Design Guide, Wood-frame](#).

Multi-unit Residential Buildings for best practice guidelines for wood frame design.

- .6 Consider the principles of Crime Prevention through Environmental Design (CPTED) in the design of the building to ensure the security of the residents and staff, e.g., natural surveillance,

activity support and access control as well as other recognized CPTED principles.

Refer to [Crime Prevention Through Environmental Design \(CPTED\)](#).

- .7 All areas of the site and all parts of the building used by the residents shall be accessible and shall be designed to consider the safety of people of all ages and degrees of abilities.
- .8 For renovation/capital improvement or conversion projects, provide accessibility to areas where persons with disabilities could be reasonably employed or are expected to use and where providing such access would be practical. Confirm acceptance with Owner and Authorities Having Jurisdiction.

### 3.2 BUILDING SIZE (NEW CONSTRUCTION PROJECTS)

#### .1 Functional Program

- .1 A Functional Program shall be prepared by the project team to confirm the space requirements of the user group and to confirm the efficiency of the building design. The Functional Program is to be submitted to BC Housing at Schematic Design Stage.
- .2 The overall building efficiency is calculated as the Total Residential Area divided by the Gross Livable Area (GLA).

Gross Livable Area is defined as the sum of habitable areas above grade and excludes underground parkades, rooftop, balcony and underground service areas. Gross Livable Area is measured to the outside line of the building sheathing.

Total Residential Area is defined as the gross area of the residential units and is measured from the centre line of party walls, the face of exterior sheathing and the centre line of the corridor walls. Circulation should be measured from the same centre line of the corridor walls.

- .3 The following approximate are the overall building efficiency targets:

- |   |     |
|---|-----|
| • Family Housing and Independent Seniors Housing<br>(Projects with basic amenity and office space only)     | 82% |
| • Supportive Housing and Assisted Living Projects<br>(Projects with additional amenities and program space) | 77% |
| • Supportive Housing for Homeless At-Risk Clients<br>(Projects with common dining and meal preparation)     | 70% |

The details on amenity, program and office spaces in these categories are discussed under [4.2 INDOOR AMENITY, PROGRAM AND OFFICE SPACES](#).

The Functional Program should be submitted to BC Housing in a similar format as shown below.

GENERIC FUNCTIONAL PROGRAM					
<b>Project Name:</b>					
<b>Address:</b>					
<b>Building Type (Wood-frame, Concrete)</b>					
<b>Parking Type (Surface, Underground)</b>					
Function	Description of units/spaces	ft <sup>2</sup> /unit or room	# of units	Total ft <sup>2</sup>	Total m <sup>2</sup>
<b>a - Residential Units</b>	Studios				
	One-bedroom				
	Two-bedroom				
	Three-bedroom				
	Four-bedroom				
	<b>Total # of units</b>				
<b>b - Resident's Amenity</b>	Lounge				
	Multipurpose rooms				
	Resident laundry				
	Common dining room				
	Commercial kitchen				
	Common washrooms				
<b>c - Administration / Program Support</b>	Offices				
	Staff washrooms				
	Staff Laundry				
<b>d - Circulation</b>	Corridors and lobby				
	Stairs				
	Elevators				
<b>e - Service Rooms (if finished and located above grade)</b>	Janitor's Room				
	General Storage				
	Heat Treatment Room				
	Electrical/mechanical				
SUMMARY					
<b>a - Total Residential Area</b>					
<b>b - Total Residents' Amenity</b>					
<b>c - Total Admin/Support</b>					
<b>d - Circulation</b>					
<b>e - Service Rooms (located above grade)</b>					

**GENERIC FUNCTIONAL PROGRAM**

**f - GROSS LIVABLE AREA**  
(a + b+ c + d + e)

**Overall Building Efficiency**  
(Total Residential area /Gross Livable Area) a / f

The project team is to use this as a guide in developing a functional programme to suit their specific requirements. The areas described above are provided only to suggest the type of spaces that can be categorized in each function.

**.2 Cost Target Framework**

- .1 For new construction projects, the BC Housing Cost Target Framework provides the project team with a basis for determining the appropriate building size and approximate development cost for the project. The Cost Target Framework shall be used by BC Housing as part of their review of the schematic and design development plans and the corresponding capital budget of the proposed project.
- .2 Refer to the Social Housing Cost Target Framework and Costing Framework spreadsheet published in the [BC Housing website](#).

## 4 Building Common Areas

**4.1 GENERAL**

- .1 Common areas for buildings consist of:
  - Indoor amenity spaces for residents use
  - Administration and Program Support Services for administrative and support staff use
  - Service Areas for maintenance and building services and storage
  - Circulation and Access in the building
  - Outdoor Spaces for recreation and services
- .2 Provision for these spaces will depend on program objectives, the level of support services to be provided for the residents, project size, location and budget parameters. These guidelines may not apply to renovation projects.

**4.2 INDOOR AMENITY, PROGRAM AND OFFICE SPACES****.1 General**

- .1 Amenity spaces are an important element of BC Housing projects. These spaces shall be designed to offer residents the option for social interaction and to encourage a sense of community within the project.
- .2 Amenity spaces should be centrally located, adjacent to outdoor common space and ideally located at grade level. Below grade amenity spaces are not acceptable. It is desirable to cluster the amenity space with other common facilities such as the laundry and project

office. For family projects, the amenity space should be located adjacent to the children's play area.

- .3 Program spaces are used to provide additional supports, training opportunities and/or recreational activities to the residents within a supportive housing environment.
- .4 Office spaces are for use by administrative and support staff. Office spaces must be designed to provide security, acoustic privacy and must consider the furniture and office equipment required by project staff.
- .5 Office and administration areas shall have visual connection to the main entry door, elevator lobby, resident amenity and program areas.
- .6 All amenity and program spaces must be wheelchair accessible. Door swing and doorways shall have appropriate wheelchair accessible maneuvering area on either side of the door. Provide an accessible route to outdoor common amenity spaces.
- .7 Maximize glazing in staff offices and common room doors such as lounges, TV rooms, children play area, and laundry rooms for improved visibility.
- .8 The amenity, program and office spaces are generally grouped into 3 categories:
  - Family Housing and Independent Seniors Housing
  - Supportive Housing and Assisted Living Projects
  - Supportive Housing for Homeless At-Risk Clients

The functional space requirements for each category are described below but should be confirmed with the Operator and/ or BC Housing.

**.9 Allowable Floor Area**

**.a Family Housing and Independent Seniors Housing**

The estimated allowable total floor area for the common amenities, office and common laundry room for family housing and independent seniors housing is estimated at 20 sf (1.86 m<sup>2</sup>) per dwelling unit with minimum and maximum ranges noted below:

- a minimum floor area of 760 sf (70.6 m<sup>2</sup>) regardless of the number of dwelling units
- a maximum floor area of 1,500 sf (139.4 m<sup>2</sup>) for 75 dwelling units and more

This is categorized as Type A Program Space in the BC Housing Social Housing Cost Target Framework.

**.b Supportive Housing and Assisted Living Projects**

The estimated total floor area for the common amenities, program and support spaces for a supportive housing project which does not include a common dining room or commercial kitchen is estimated at 45 sf (4.18 m<sup>2</sup>) per dwelling unit, with minimum and maximum ranges noted below.

- a minimum floor area of 1,710 sf (158.9 m<sup>2</sup>) regardless of the number of dwelling units
- a maximum floor area of 2,340 sf (217.4 m<sup>2</sup>) for 52 units and more

This is categorized as Type B Program Space in the BC Housing Social Housing Cost Target Framework.

- .c The estimated total floor area for the common amenities, program and support spaces for a supportive housing project which includes a common dining room and commercial kitchen is estimated at 80 sf (7.42 m<sup>2</sup>) per dwelling unit, with minimum and maximum ranges noted below.
  - a minimum floor area of 2,360 sf (219.3 m<sup>2</sup>) regardless of the number of dwelling units
  - a maximum floor area of 3,760 sf (349.3 m<sup>2</sup>) for 47 units and more

This is categorized as Type C Program Space in the BC Housing Social Housing Cost Target Framework.

## **.2 Family Housing and Independent Seniors Housing**

- .1 Amenity spaces provided in independent housing for seniors and families consist of:

- A multi-purpose room with storage room or closet
- An amenity kitchenette
- A gender-neutral accessible common washroom

The accessible common washroom and amenity kitchenette shall be adjacent to the multi-purpose room.

- .2 The amenity kitchenette shall be provided with:

- Minimum length of 2.4 m (8'-0") of upper and base cabinet, microwave outlet and shelf, and double bowl stainless steel sink
- 0.41 m<sup>3</sup> (14.5 ft<sup>3</sup>) refrigerator
- 760 mm (2'-6") residential electric range and residential range hood
- Dishwasher (confirm with Owner if required)

- .3 Provide an office(s) for the use of building management and maintenance staff. Review requirements with the Owner. The office should have a lockable transaction window, a solid core wood or steel door with mail slot. Provide millwork, security, telephone, cable and data outlets.

- .4 Provide a wheelchair accessible common laundry room that is conveniently located for the tenants.

## **.3 Supportive Housing and Assisted Living Projects**

Housing with direct support services to the residents such as assisted living projects, transition homes and second stage housing shall provide program space to allow for social, recreational, consultation and group learning activities as well as spaces for administrative and staff functions. The following spaces and features are recommended to meet these needs. Confirm specific client needs during the programming phase.

- .1 Lounge / Activity Rooms

- Options of small sitting/reading areas and larger multi-use activity spaces

- Space for bookshelves
- Storage room or closet for tables, chairs and equipment
- A gender-neutral wheelchair accessible common washroom adjacent to the lounge/activity space
- Telephone, cable and data outlets

#### **.2** Amenity kitchenette

- Typically provided within the lounge or multi-purpose area, if required by the Owner. Provide the following as a minimum:
  - Minimum length of 2.4 m (8'-0") of upper and base cabinet, microwave outlet and shelf, and double bowl stainless steel sink
  - 0.41 m<sup>3</sup> (14.5 ft<sup>3</sup>) refrigerator
  - 760 mm (2'-6") residential electric range and residential range hood
  - Dishwasher (confirm with Owner if required)

Amenity kitchenettes are not intended for commercial cooking purposes.

#### **.3** TV Room

- Electrical and cable outlets for a wall-mounted large screen TV
- Sound rated wall assemblies rated at STC 55 minimum
- Design for residential furniture and finishes – easy chairs, sofa, etc.

#### **.4** Computer Stations

- At least 2 computer stations with electrical, telephone and data outlets for high speed internet connection; locate computer stations in common areas that can be easily monitored by support staff.

#### **.5** Common Dining and Commercial Kitchen

- For projects which will be funded to operate a commercial kitchen and meal service for the residents, it is recommended that a commercial kitchen designer be engaged early in the design process to advise on space and other system requirements for a commercial kitchen suited to the scale of the project.
- The local Authority Having Jurisdiction must be consulted to determine requirements for ventilation, exhaust, fire suppression and other building code requirements.
- The ease of maintaining commercial exhaust and ductwork and location of required access hatches should be considered when locating the kitchen.
- Locate the commercial kitchen with access to a separate service entrance or loading bay, where possible.
- Provide pantry storage area with shelving for non-perishable items.
- Common dining rooms may be designed for single or multiple seating services depending

on the scale of the project, building size limitations or type of meal service to be provided.

- Common dining space shall be designed in a way that the flow of traffic, easy access to food, utensils and waste disposal are considered. Provide microwave outlet and shelf, a 0.34 m<sup>3</sup> (12.0 ft<sup>3</sup>) refrigerator and a single bowl sink for tenant use in this space.
- .6** Offices for administration and program support staff
- At a minimum, provide a front office/reception area, manager office, and tenant support/counselling room. Provide millwork, security, telephone, cable and data outlets.
  - Provide a minimum rating of STC50 or ASTC47 for wall and ceiling assemblies.
- .7** Staff room with adjacent staff washroom. Provide millwork with sink, bar fridge and microwave shelf. Provide space for lockers for a minimum of 4 staff. Provide staff washroom with a toilet and vanity with sink.
- .8** Gender-neutral accessible common washroom for guests and for intake use. Refer to Article 4.2.5. Consider a prefabricated shower stall in transition housing, if required.
- .9** Common laundry room for use of residents and a separate staff laundry room. Refer to Article 4.2.6 for the number of pairs of washers /dryers required. For staff laundry, provide one pair commercial grade washer/dryer at a minimum.
- .10** Storage room(s) for bulk items, linen, furniture, donated items and maintenance materials.
- .11** All other essential spaces required by the Operator to meet their functional and operational requirements for the project.

Refer to the BC Housing's Design Guidelines for Women's Transition and Second Stage Housing for additional design and security considerations for this specific client group.

#### **.4 Supportive Housing for Homeless At-Risk Clients**

For supportive housing where 24/7 direct support services are provided to homeless at-risk clients, the following minimum program spaces and design requirements shall be considered. Consult the Owner/Operator to confirm their functional requirements at the programming phase.

- .1** Secured main entrance consisting of a 1220 mm (4'-0") wide entry door with a vestibule. Provide for audible connection and visual screening between front office staff and tenant/visitors before allowing their entry into the vestibule. Both sets of entry doors shall be electronically controlled from the front office.
- .2** Front office/reception with line of sight to the street entry to the property, main entry to the building, elevator (if provided) and amenity spaces.
- Reception office to have sliding glass window to allow communication with visitors and provide a pass-through for documents/items. Window opening should be lockable and designed to ensure staff safety. The window glass shall be laminated glass or tempered glass with shatter resistant film on the inside.
  - Main door to the reception office should be a Dutch style door with a shelf, and a deadbolt accessible from inside. This is to provide separation and security while

interacting with tenants. Consider providing a secondary door for egress and a panic alarm system. Confirm these requirements with the building operator.

- .3 Manager's office with space for office furniture; provide telephone/data outlets.
- .4 Tenant support worker office/counselling room with sitting space for two and telephone/data outlets. Provide a secondary door and panic alarm system. Consult the Owner/Operator for requirements.
- .5 Staff room with adjacent staff washroom. Provide millwork with sink, bar fridge and microwave shelf. Provide space for lockers for a minimum of 4 staff. Provide staff washroom with a toilet, vanity with sink.
- .6 Medical room - Provide a sink and space for a lockable cabinet, examination bed, millwork and small desk. Consult the building operator if a secondary exit door and/or Dutch style door with shelf is required.
- .7 Harm reduction supplies and needle disposal - Provide space that can be easily accessed by the residents. Consult the Owner/Operator if a safe consumption room is required. If so, refer to the building Operator/Operator agreement for requirements.
- .8 Tenant Lounge and multi-purpose amenity spaces
  - Design as a multi-purpose space for programmed activities such as meetings, training and group activities. Consider possible use of these spaces as a temporary shelter in extreme weather conditions.
  - Provide lounge with seating space for at least 30% of the total unit/bed count.
  - Provide electrical and cable outlets for wall-mounted TV and telephone/ data outlets for computer stations
- .9 Common dining room for tenants - Provide seating for minimum 75% of the residents. Provide a counter with single bowl sink and space for a coffee station.
- .10 Commercial kitchen and storage pantry - Shall be Class 1 cooking operations as defined by the City of Vancouver, unless otherwise confirmed by the Operator/Operator.
- .11 Common washroom - Provide at least one wheelchair accessible gender-neutral washroom with sink and toilet. Owner to confirm if an emergency alarm switch or pullcord will be required. Refer to Article 4.2.5.
- .12 Wheelchair accessible laundry room - Provide a common laundry room for tenant use. Refer to Article 4.2.6 for requirements. Provide a separate staff laundry room with one pair washer/dryer as a minimum, if required by the Owner.
- .13 Storage room(s) for bulk items, furniture, extreme weather beds and maintenance materials.

If the project will include emergency shelter beds, refer to the [BC Housing Shelter Design Guidelines](#) for additional design considerations.

## **.5 Common Washrooms**

- .1 Common washroom(s) shall be adjacent to the common amenity space in all projects. At least one common washroom shall be wheelchair accessible.

- .2 Provide slip-resistant resilient vinyl flooring with integral flash cove and floor drain with trap primer.
- .3 Provide a toilet, vanity with sink and common washroom accessories such as toilet paper holder, soap dispenser and towel dispenser. Consider low-flow spring loaded faucets to mitigate flooding.
- .4 All washrooms doors shall swing out.

## **.6 Common Laundry**

- .1 All common laundry rooms shall be designed to be wheelchair accessible and ideally located adjacent to the common amenity space.
- .2 The recommended number of laundry equipment is one pair of washer and dryer for every 15 units.
- .3 Washers and dryers shall be commercial grade; at least one of these should be front loading on pedestals with controls and operating mechanisms at accessible height. Provide a clear floor area of at least 750 mm x 1200 mm (2'-6" x 4'-0") in front of each appliance and laundry sink.
- .4 The Owner shall confirm the type of equipment supply arrangement and laundry equipment operation (e.g. contractor or Owner supplied; coin operated or card-operated).
- .5 Provide a single bowl stainless steel laundry sink and a table or countertop for sorting or folding. The counter shall be installed at accessible height and shall be designed with an open knee space clearance.
- .6 The laundry room should be well ventilated to avoid moisture issues. Locate laundry rooms close to the exterior of the building to minimize the length of dryer duct runs and to avoid lint and moisture build-up within the ducts.
- .7 Laundry rooms shall be finished in non-slip resilient flooring with integral flash coved base and floor drain complete with trap primer.
- .8 Provide glazed doors to improve security and access to the laundry room, to the maximum permitted by the applicable building code.
- .9 Lighting in laundry rooms should be triggered by motion detector or occupancy sensor.
- .10 Provide for a sitting space inside the laundry room.
- .11 For cost efficiency and to improve energy efficiency, avoid the use of multiple common laundry rooms.

## **4.3 SERVICE AREAS**

### **.1 Underground/Enclosed Parking**

Design underground parking areas to maximize building and occupant security. Consider safety provisions for stair and elevator lobby vestibules, including:

- Maximize glazing with fire rated glass in steel frames in stair and elevator vestibules within the requirements of the applicable codes.

- Light levels and lighting design for the parkade ramp, traffic aisles, vestibules, stairwells and elevator lobbies shall be designed as recommended in [Crime Prevention Through Environmental Design \(CPTED\)](#) section.
- Coordinate structural, electrical, fire protection, and mechanical systems to ensure adequate clearances for access to parking stalls and exits.

## **.2 Bicycle Parking**

If required by the municipality or the Owner, provide secure internal bicycle parking for building occupants and staff. Provide suitable access to the exterior. Confirm parking requirements with municipality. At a minimum provide exterior bike racks if not provided inside the building.

## **.3 Garbage / Recycling Rooms**

- .1** Provide a conveniently located area for collection and storage of garbage, recyclable materials, and organics. Confirm requirements with municipality. Review acceptability of proposed access and pick-up with municipal or private garbage collection agencies.
- .2** In urban areas provide an enclosed garbage room with adequate room for garbage and recycling containers and tractor, if required for pick up. Include mechanical ventilation for odour control. Do not heat room or only provide minimal heat.
- .3** Walls and floors of the room should be protected and designed to accommodate heavy equipment. Provide a hose bib close to garbage room. Provide positive slopes to sanitary drain.
- .4** Where garbage bins are located outdoors or adjacent to parking areas, install the bins on a concrete pad. Do not install directly on asphalt pavement.

## **.4 Receiving**

- .1** Where the project requires a commercial kitchen, provide for a separate receiving or service entrance.
- .2** Confirm requirements for loading facilities and moving trucks with municipality.

## **.5 Equipment Storage and Maintenance**

- .1** Provide an insulated, finished space for maintenance and general building storage, appropriate to the requirements of the project, ideally with direct access to the exterior for garden and lawn maintenance equipment. Allow space for storage of emergency supplies.
- .2** The storage space should be heated, well lit, and have a minimum of four separate duplex outlets located at bench height.

## **.6 Tenant Storage**

- .1** If required, provide an additional heated storage room (such as tenant's locker) to supplement the tenants' in-suite storage. Confirm storage requirements with Owner and municipality.
- .2** The doors for accessible units' storage shall swing outward with accessible maneuvering space located close to the storage main door entry.

## **.7 Janitor Closets**

Provide a janitor closet on the ground floor, minimum 2.8 m<sup>2</sup> (30 ft<sup>2</sup>) in area with a mop sink,

shelves, mop brackets, and floor drain. In projects with an elevator and more than 50 units, provide additional janitor closets on the upper floors, such as at every third floor, as required for efficient access. Locate close to elevators. In low-rise projects without an elevator, provide a janitor closet on every floor, if required by the Owner/Operator.

### **.8 Postal Services**

Where mail is not delivered to each unit, provide secure mailboxes located in the lobby area. Where there is no secure lobby area, ensure that the mailboxes are located in a secure common area which is protected from the weather. Buildings with more than 100 units will require a secure mail room and rear loading mail boxes. Review proposed mailbox location with Canada Post and confirm acceptance of design. Provide the minimum accessible requirements for maneuvering space and reachable range for mailboxes.

### **.9 Utility Lock Boxes**

- .1** All lock boxes for utility service providers and fire department access must be clearly marked to identify ownership.
- .2** Lock boxes installed on the exterior of the building shall be located at the main entrance, or in the case of multi-building sites such as townhouses, outside of a secure location on the site such as the site office, common room, or a selected service room.
- .3** All external lock boxes must be flush-mounted only and should be anchored into the exterior structural wall system. Surface mounted lock boxes are not acceptable.
- .4** All indoor lock boxes should be located in an area of high visibility.

### **.10 Scooter Storage**

For Seniors projects, provide a dedicated scooter storage room. Confirm required numbers with the Owner and the municipality. Each scooter room should provide:

- access to the exterior, ideally located near the entrance to the building
- automatic door opener with access control
- a minimum 1015 mm (3'-4") wide door
- outlets for recharging
- ventilation and adequate lighting
- storage for spare batteries
- wall protection up to 1220 mm (4'-0")
- a minimum scooter maneuvering space at the entry and within the room

### **.11 Mechanical and Electrical Rooms**

- .1** The Owner shall review the location, space and technical requirements with the mechanical and electrical consultants as part of the integrated design process to ensure the most effective design. Ensure that the mechanical and electrical rooms are located as close as possible to the entry point for utilities. Locate for efficient distribution, including space and access for servicing.

Mechanical room location in the building, access, clearance, future replacement of equipment, structural requirements, noise transmission and construction must be considered early at the design stage.

- .2 Mechanical and electrical rooms shall have an access path and adjacent areaway of sufficient size to allow for the removal of the largest piece of equipment without disassembly of the equipment.

Mechanical rooms located on the roof shall be provided with proper stair access.

- .3 Where service rooms are located adjacent to tenant suites, additional noise and vibration measures must be incorporated to ensure that the noise and vibration from the systems do not disrupt the residents living in those particular units.
- .4 Where air handling equipment is located outside on roofs or decks, engage an acoustic consultant to recommend mitigation measures to prevent noise transmission both internally within the building and to the neighbouring area.
- .5 Weather-tightness is required for all construction surrounding mechanical, electrical, or water vulnerable equipment if the room is located below grade. Mechanical and electrical room, switchgear or panel must be located above a Flood Construction Level (FCL).
- .6 All mechanical rooms shall have adequately primed floor drains located in close proximity to those pieces of equipment most likely to leak or require draining for servicing or replacement. Slope floors to drains.
- .7 Mechanical room door width must be 915 mm (3'-0") at a minimum, 1015 mm to 1067 mm (3'-4" to 3'-6") is preferred.

#### .12 Heat Treatment Room (optional)

Provide for a heat treatment (or bed bug treatment) room, if appropriate to the project.

Provide insulation to walls, floors and ceilings to allow the room to reach the required operating temperature throughout the room. Provide a heat source and provisions for exhausting heat after treatment or use. Instructions to staff for the use of the heat treatment room should be posted.

Refer to [Construction Standards, Division 13 20 00 - Heat Treatment Room](#) in these guidelines.

## 4.4 CIRCULATION AND ACCESS

### .1 Entrance Lobby

- .1 Provide a clear and level area minimum of 1500 mm x 1500 mm (5'-0" x 5'-0") at the main entrance door, both outside and inside.
- .2 Provide level or roll-over (flush or beveled) at all entrance doors, threshold shall be no more than 13 mm (1/2") high, with beveled edges with a slope no more 1:2.
- .3 Provide a clear accessible path from the main entrance to all parts of the building. Finish floor surfaces shall be stable, firm, slip-resistant.
- .4 A building enterphone system shall be installed with easy to use controls, and installed to meet accessibility requirements and in consultation with the AHJ. Ensure that the system is compatible with the security system and any auto door openers. For row-house projects, provide a door bell at the entrance door with controls at an accessible height.
- .5 Provide mailboxes and shelf with adequate lighting levels and adequate font / label sizes located at an accessible location and height.

- .6 Provide a vestibule to prevent heat loss and drafts to the lobby area. Review ASHRAE requirements for vestibules. Provide walk off mats to prevent outside dirt and debris from tracking in to the building. For multi-unit buildings, consider a recessed walk off mat with drainage.
- .7 For assisted living and independent seniors projects, provide a sitting area in the main lobby or close to the elevators with a view to pick up and drop off areas.  
  
Consider a level mobility aid space of at least 2250 mm x 2250 mm (7'-5" x 7'-5") in front of the main entrance as a vehicle drop off point for vehicles.

## .2 Corridors

- .1 Corridors shall have no steps or level changes and finished floor surfaces shall be stable, firm and slip resistant.
- .2 Common corridors serving more than four units shall be at least 1525 mm (5'-0") wide.
- .3 Provide visual interest to common corridors using features such as colour, provision of outside views and well designed lighting.
- .4 Provide colour contrast between floor and wall finishes with minimal glare and not be heavily textured.
- .5 Avoid complex and long stretches of corridors.
- .6 Maximize glazing in public corridors including doors at fire separations, exit stairs and common areas as permitted by code to enhance personal security of residents.
- .7 Provide wall protection or corner guards in high traffic areas.
- .8 For assisted living projects, in addition to the above, provide for the following:
  - provide handrails on one side of the corridor or as required by the code.
  - travel distance should be minimized and not exceed 30 m (98'-5") from any suite entry door to the elevator.
  - consider integrating hand rail design with parcel shelf at suite entry and elevator entrance.
  - dead end corridors shall be limited to 2 m (6'-7") in length.

## .3 Exit Stairs

- .1 For assisted living projects lighting at exit stairs and primary egress routes shall be 100 lx average illumination at floor and tread levels. Emergency lighting shall provide minimum 50 lx at stair treads and 20 lx in level paths of travel. These light levels are double the minimum building code requirements to accommodate the high percentage of tenants with visual impairment.
- .2 Incorporate day lighting from exterior windows in stairwells, and hallways, whenever possible.

## .4 Elevators

- .1 Multi-unit buildings of two or more storeys above grade without direct grade access must have at least one elevator conveniently located near the main entrance. All underground

parking levels must be served by at least one elevator. Refer to [9.2 - Elevators](#) of this section for the number of elevators for senior's projects.

**.2** Ensure that floor levels are clearly identified. Investigate use of colour coding and/or graphics to assist wayfinding.

**.3** Refer to [Section 1.9 Building Systems](#) for additional requirements.

#### **.5 Interior Stairs**

For 2 storey residential units, **consider a minimum 1067 mm (3'-6") clear** for the passage of queen-size beds and furniture without damage to walls. **For interior stairs in 2 storey family projects, add solid reinforcing at the top of stairs for future installation of a child safety gate. Consider adding reinforcement to stair walls and electrical outlets for future chair glider.**

#### **.6 Access Hatches**

For security reasons, attic access **and access hatches** shall be lockable and located in common areas such as corridors and lobbies.

### **4.5 OUTDOOR SPACES**

#### **.1 Site Drainage**

**.1** A comprehensive site water management strategy should be developed by the project team at an early stage. Erosion control, and storm water management should be addressed. Investigate measures such as pervious paving, rain gardens, bio swales, storm water retention and storm water treatment.

**.2** Ensure that site grading is designed to slope away from the building areas.

**.3** Ensure that appropriate drainage systems are put in place to deal with run-off from adjacent sites.

**.4** Ensure that area drainage is provided to avoid water and ice accumulation particularly in areas used by the residents.

**.5** Where feasible, retain the maximum amount of existing planting materials and top soil. If trees and vegetation are removed investigate the impact on the site drainage.

#### **.2 Parking**

##### **.1 General**

- Provide on-site parking as required by the municipality. Where possible provide surface parking.
- Based on client type, need and proximity to the rapid transit or transit hub, a request for parking relaxation from the municipality should be investigated. Where required, engage a traffic consultant to prepare a Traffic Demand Study which will analyze the current and future parking requirements.
- Consider providing designated parking for alternate fuel vehicles, carpools, vanpools or car co-ops.

##### **.2 Seniors Projects**

- Where outdoor parking is provided, do not exceed 25 m (82'-0") as the exposed walking distance from the parking lot to the building entrance.
- Where possible and allowed by the municipality, provide a vehicular drop-off point that is designed with a height clearance for Handy Dart or over height vans. Provide a weather-protected route to the building entry.

### **.3 Parking Space Identification**

All parking areas shall meet municipal delineation regulations.

### **.4 Accessible Parking Spaces**

Provide accessible parking, all with required pavement markings and signs, as required by municipal regulations and BC Building Code. Locate as close as possible to the building entrance or elevator lobby.

### **.5 Block Heater Outlets**

Parking lots in colder climates should be provided with block heater outlets with timers. Install the outlets in impact resistant metal or concrete bollards adjacent to the parking stall and not across walkways to prevent cords running across the walkways.

### **.6 Electric Vehicle Charging**

Provide electric vehicle charging stations as required by the Owner or the municipality.

## **.3 Outdoor Recreation Areas**

- .1** Projects should incorporate a conveniently located outdoor open area near amenity space that is universally accessible from the main building and promotes positive social interaction.
- .2** The exterior recreation area should permit residents to relax and sit in the sun or shade, out of the wind, in quiet spots or with a large group. To facilitate these activities consider the following:
  - A hard surface patio
  - Weather protected areas at the common patio through the use of an awning, canopy, building overhang or gazebo.

### **.3 Resident Garden**

Where required by the Owner, provide an outdoor area for resident gardening. Consider the location and size of the area, access to sunlight and water, proximity to other structures, lighting and security, types of plants and tools, as well as accessibility. Provide raised beds to facilitate access for tenants with wheelchair or restricted movement.

### **.4 Outdoor Smoking Area**

An outdoor smoking area may be designated, if required, to meet resident or licensing requirements. Review municipal requirements for the minimum distance from adjacent doors, operable windows, and intake louvers.

### **.5 Outdoor Play Spaces for Families and Women's Transition and Second Stage Housing**

Provide adequate and secure play space for children. Locate play spaces so they are overlooked by common facilities such as the amenity building, laundry rooms and individual dwelling units. Rules for play areas should be provided and posted.

#### **.6 Outdoor Spaces for Seniors**

Provide an exterior recreation area that is conveniently accessible from the common amenity area.

The exterior recreation area should permit tenants to participate in both active and passive activities such as:

- watching outside street life.
- sitting in the sun or shade, out of the wind, in both quiet spots and with a large group walking conveniently without encountering stairs.

#### **.7 Bicycle Parking**

Provide exterior bicycle parking as required by the Owner and the municipality.

#### **.8 Outdoor Storage Areas**

If not within the building, provide secure storage for gardening tools, lawnmowers, chairs, etc.

## 5 Dwelling Unit Design

### **5.1 GENERAL**

- .1** The following design guidelines are intended for self-contained dwellings in multi-unit residential buildings, regardless of building form.
- .2** Provide Owner with unit plan drawings of proposed units which show possible furniture arrangements in all living areas at schematic design stage.
- .3** Wherever applicable, adopt the 15-point universal design standards published in the [SAFERhome Standards Manual](#). These standards provide a safer home environment for the residents and keep them active and independent in their homes.
- .4** Where units are intended for seniors or to be adapted for future modification for persons with disabilities, reference should be made to BC Building Code, Section 3.8.5 Adaptable Dwelling Units.
- .5** In order to ensure the functionality and livability of units designed for seniors to live as independently as possible in their community of choice, preference shall be given to designing seniors' dwelling units as adaptable one-bedroom units. See [8.3 Adaptable Units](#).
  - Subject to need and demand, design restrictions or other considerations that could seriously affect the viability of a project, other options such as smaller adaptable one-bedroom units (minimum of 470 sf) or adaptable studios can be considered with BC Housing's prior approval.

## 5.2 DWELLING UNIT FLOOR AREAS

Dwelling units shall be designed within the following Net Unit Areas. Net Unit Area is the dwelling area calculated from the centre line of party walls, corridor walls and the outside face of the sheathing on exterior walls, and includes in-suite storage. Confirm difference in definition of net area with municipality.

Unit Type	Bedroom	NET UNIT AREA	
		Sq. Metres	Sq. Feet
Townhouse	1	56 m <sup>2</sup>	600 ft <sup>2</sup>
	2	90 m <sup>2</sup>	969 ft <sup>2</sup>
	3	111 m <sup>2</sup>	1195 ft <sup>2</sup>
	4	125 m <sup>2</sup>	1345 ft <sup>2</sup>
Apartment/Single Storey Apartment (Motel Type)	Studio	33 m <sup>2</sup>	350 ft <sup>2</sup>
	1	49 m <sup>2</sup>	525 ft <sup>2</sup>
	2	67 m <sup>2</sup>	725 ft <sup>2</sup>
	3	86 m <sup>2</sup>	925 ft <sup>2</sup>
	4	112 m <sup>2</sup>	1200 ft <sup>2</sup>

- .1 Net Unit Areas may be increased by up to 12% to achieve wheelchair accessibility and by up to 5% for adaptable units.
- .2 Owner / operators should carefully review the demand for unit types in their community to avoid overbuilding. For instance, avoid renting out 2 bedroom units to single occupants. At a minimum each bedroom should be occupied by a tenant.

## 5.3 LIVING-DINING AREAS

### .1 Suite Entrance

- .1 Provide a defined, primary entrance area to the suite. Provide a coat closet close to the entrance. Size of the closet is a function of the suite size but should be a minimum of 915mm (3'-0").
- .2 The entry coat closet must have a minimum effective depth of 600 mm (2'-0") and be equipped with a coat rod and a 300 mm (1'-0") deep shelf.

### .2 Living Area

- .1 Living areas should be designed to provide for seating capacities in accordance with the requirements noted below. Seating capacity may be provided by any reasonable combination of sofas, love seats and armchairs. Confirm with furniture plan.

UNIT TYPE	LIVING AREA SEATING CAPACITY
Studio	2
One Bedroom Units	4
Two Bedroom Units	5
Three Bedroom Units	6
Four Bedroom Units	7

- .2 Through circulation spaces should be a minimum of 920 mm (3'-0") wide.
- .3 It is recommended that any interior hallway width inside the suites are a minimum of 1015 mm (3'-4"). For accessible and adaptable units, it is recommended to have a minimum width of 1067 mm (3'-6").
- .4 Suggested furniture layouts should be coordinated with baseboard heater and forced air vent locations as appropriate.

### .3 Dining Area

- .1 Dining areas should be designed to provide for seating capacities in accordance with the requirements noted below.

UNIT TYPE	DINING SEATING CAPACITY
Studio	2
One Bedroom Units	4
Two Bedroom Units	4
Three Bedroom Units	6
Four Bedroom Units	8

## 5.4 BEDROOMS

### .1 General

- .1 Locate bedrooms and sleeping areas so that they are visually separated from the unit entrance.
- .2 Avoid designs that locate beds under windows. Avoid conflicts with baseboard heaters.
- .3 Locate doors so that they are able to open a full 110 degrees.
- .4 Allow access to both sides and the foot of all beds.
- .5 Avoid possible conflict between the placement of beds and access to the clothes closet.
- .6 Each bedroom should be provided with a window(s) to allow natural ventilation and daylighting.

### .2 Bedroom Types

The bedrooms are classified into three types as per the table below:

BEDROOM TYPE	BED
A	2 Single
B	1 Double
C	1 Single

Provide a combination of bedroom types as noted. The bedroom types are defined by minimum dimensions, areas and furniture requirements.

UNIT TYPE	BEDROOM TYPE
One Bedroom Units	B
Two Bedroom Units	A, B
Three Bedroom Units	A, B, C
Four Bedroom Units	A, B, C, C

### .3 Bedroom Sizes

- .1 It is recommended that bedrooms are designed to the following minimum areas and dimensions. Test all rooms with furniture plan layout.

BEDROOM TYPE	MINIMUM FLOOR AREA	MINIMUM DIMENSION	MINIMUM CLOSET WIDTH
A	11.15 m <sup>2</sup> (120 ft <sup>2</sup> )	2.8 m (9' - 2")	1.5 m (5' - 0")
B	9.3 m <sup>2</sup> (100 ft <sup>2</sup> )	2.8 m (9' - 2")	1.5 m (5' - 0")
C	8.5 m <sup>2</sup> (92 ft <sup>2</sup> )	2.6 m (8' - 6")	0.915 m (3' - 0")

- .2 The required areas and dimensions shall be measured between finished wall surfaces.
- .3 The required areas do not include closet areas.

## 5.5 IN-SUITE STORAGE

### .1 General Storage

- .1 Provide a total of 2.3 m<sup>2</sup> (25.0 ft<sup>2</sup>) of general storage for each dwelling unit. This can be provided in-suite or in combination with storage lockers elsewhere in the building. Review Owner's and municipal requirements for additional storage requirements.
- .2 For studio units, this storage requirement may be relaxed if acceptable to the owner and the municipality.
- .3 Provide three, 400 mm (1' - 4") deep adjustable shelves along one wall of all in-suite storage areas.

### .2 Linen Closet

Provide linen storage with four adjustable shelves in a location readily accessible to the main bathroom and bedrooms.

### .3 Bedroom Closets

Equip all clothes closets with one shelf and integral coat rods with an unsupported span of less than 1000 mm (3'-3"). Install to barrier free design heights in all wheelchair accessible units.

# 6 Kitchens and Bathrooms

## 6.1 KITCHENS

### .1 General

The kitchen should be located adjacent to or connect directly with the dining area (e.g., a kitchen pass-through). Provide L-shaped kitchen configurations whenever possible. Avoid galley kitchen configurations if possible.

### .2 Fixtures and Appliances

- .1 Provide for a stainless steel, double bowl sink with low-flow, single-lever faucet. Do not install a garburator.
- .2 Provide for a frost-free refrigerator, easy-clean range and 2 speed 180 cfm range hood. Refrigerators shall be ENERGY STAR® rated. Refer to [Energy and Environmental Design](#) section.
- .3 For studios: A cooktop may be installed in lieu of a range, if specifically preferred by the user group. Provision of a single bowl sink is acceptable.
- .4 For family, seniors and adaptable projects: Provide plumbing and electrical rough-in to allow future installation of a 600 mm (2'-0") dishwasher.
- .5 Waste pipes in bathroom and kitchen sinks shall be roughed into the wall no higher than 355 mm (1'-2") from floor level to the centre of the pipe. This will facilitate future lowering of the countertops when converting to a wheelchair accessible unit.

### .3 Counter Frontage

Counter frontage or lengths shall be as recommended below. Counter frontage must be calculated from the front edge of the counter. Calculations exclude range and refrigerator spaces.

Studio	1860 mm	6' - 0"
One and Two Bedroom Units	2440 mm	8' - 0"
Three Bedroom Units	2890 mm	9' - 6"
Four Bedroom Units	3340 mm	11' - 0"

### .4 Kitchen Cabinet Design

- .1 Provide a minimum of four sliding drawers in each kitchen with one deep bottom drawer for pots and pans.
- .2 Each base cabinet shall have one intermediate, fully adjustable shelf.
- .3 All base corner cabinets shall have full height doors equipped with wire swing out swivel baskets or Lazy Susan. Provide doors with a minimum leaf width of 230 mm (9").  
Inaccessible corners are not acceptable.
- .4 Provide D- pull handles which are easily graspable.
- .5 Provide for a microwave shelf and outlet or allow for counter space for a microwave oven.

- .6 Family, seniors and adaptable units: Provide a 600 mm (2'-0") base cabinet on one side of the sink cabinet that can be removed for future installation of a dishwasher.  
  
Refer to [Construction Standards, Division 12 32 00 - Manufactured Wood Casework](#), [Division 11 30 00 - Equipment](#), and [Division 22 00 00 - Plumbing](#) for detailed requirements.
- .7 Wherever possible, cabinets under kitchen and bathroom sinks should be easily removed to allow future adaptability for wheelchair users.

## 6.2 BATHROOMS

### .1 General

- .1 The location of bathrooms should address the need for visual and acoustical privacy.
- .2 Bathrooms and powder rooms should be accessible from a common hallway.
- .3 Provide privacy locks on bathroom doors.
- .4 Provide non-slip, resilient sheet flooring with flash cove base. The provision of floor drains in the bathroom should be considered, based on the anticipated need of the users. **Floor drains shall be provided in bathrooms in wheelchair accessible units, and in homeless at-risk projects.**
- .5 Ensure that accessories such as toilet paper holders, robe hooks and towel bars are conveniently located and easily reachable by the residents.

### .2 Fixtures and accessories

Provide the following for all units:

- .1 Provide low water consumption fixtures such as low flush water closets and low flow, single lever showerheads and faucets. Refer to [Energy and Environmental Design](#).
- .2 Vanities or lavatory countertops for three-piece bathrooms should have a minimum length of 915 mm (3'-0") and be equipped with a lockable drawer. Provide a plate glass mirror the same width as the vanity or a mirrored medicine cabinet.
- .3 Provide a 610 mm (2'-0") towel bar, stainless steel shower rods with flange, and nylon curtain hooks, toilet paper holder and robe hook. Ensure adequate blocking behind all bathroom accessories.
- .4 Provide 610 mm (2'-0") vertical grab bars with solid backing at both ends of the shower or bathtub.
- .5 Provide 38 mm x 286 mm (2" x 12") horizontal blocking installed at 915 mm (3'-0") from the top of finish floor around the shower, bathtub and beside the water closet for future installation of grab bars. Review additional municipal requirements.

Refer to [Construction Standards section, Division 22 00 00 Plumbing](#), for details on plumbing fixtures and accessories.

- .6 Refer to [Article 6.1 Kitchens](#) for waste pipe height under bathroom sinks.

### .3 Studios and One Bedroom Units

- .1 Provide one three-piece bathroom consisting of a 915 mm x 1220 mm (3'-0" x 4'-0") prefabricated **non-slip gelcoat** shower with **low threshold curb 75 mm to 100 mm (3" to 4")**, water closet, and lavatory basin with vanity. Alternate sizes of showers units may be proposed if acceptable to the Owner.
- .2 For Shelter or Homeless At-Risk studio or multi-bed configuration rooms, a 915 mm x 915 mm (3'-0" x 3'-0") prefabricated **non-slip gelcoat** shower can be considered.
- .3 For renovation of existing buildings, the choice of showers or bathtubs shall be **confirmed by the Owner or BC Housing**.

### .4 Two Bedroom Units

Provide one three-piece bathroom consisting of standard size bathtub or 915 mm x 1525 mm (3'-0" x 5'-0") prefabricated **non-slip gelcoat** shower with **low threshold curb 75 mm to 100 mm (3" to 4")**, water closet, and lavatory basin with vanity. Alternate sizes of shower units may be proposed if acceptable to the Owner.

### .5 Three or More Bedroom Units

As above, plus provide one powder room consisting of a water closet and lavatory basin with vanity.

### .6 Seniors Units

- .1 Provide one three-piece bathroom including a 915 mm x 1525 mm (3'-0" x 5'-0") prefabricated **non-slip gelcoat** shower with provision for a seat, adjustable telephone-type showerhead, water closet, and lavatory basin with vanity. Alternate sizes of shower units may be proposed if acceptable to the Owner.
- .2 The use of roll-in showers should be considered where necessary to meet the needs of target users.
- .3 Provide ADA compliant low flush water closets with the seat at **430 mm to 480 mm (1'-5" to 1'-8")** from the floor, with bolted lids. Refer to plumbing section.
- .4 Provide solidly backed grab bars beside the water closet and in the shower installed in accordance with the BC Building Code.
- .5 Grab bars and towel bars shall be designed and installed to withstand a load of 1.3 kN.
- .6 Refer to [Finishes and Materials](#) in this section for door width and swing requirements.
- .7 Provide removable cabinets under kitchen and bathroom sinks if possible to allow future flexibility to create an open knee space for wheelchair users in future. Refer to [Kitchens and Bathrooms](#) in this section for lowering waste pipe under sinks.
- .8 Position bath and shower controls halfway between the outer edge and the centreline of the tub or shower enclosure to avoid having to lean in and reduce the potential slip and fall accidents. Refer to [SAFERhome Standards Manual](#).

# 7 Finishes and Materials

## 7.1 GENERAL

- .1 Refer to [Construction Standards](#) section for detailed requirements for interior and exterior finishes.
- .2 The selection of interior and exterior materials is a vital part of a project's sustainability strategy. **Consider** the environmental impact of all materials selected (recycled content, low emitting, local availability etc.) Refer to [Energy and Environmental Design](#).
- .3 All interior and material finishes shall be durable and easy to maintain and service.

## 7.2 INTERIOR FINISHES

### .1 General

- .1 Design and construct wall, floor and ceiling assemblies in all areas of the building to comply with the sound rating requirements of the current version of BC Building Code (STC50 or ASTC47) except TV room, elevator hoist way and machinery areas, plumbing party walls, or unless otherwise noted in BC Housing Guidelines.
- .2 Paint finishes and sealants shall be low odor and low VOC. Provide MPI specified products and painting systems.

### .2 Interior Walls

- .1 Walls within dwelling units and common areas shall be finished with painted gypsum board.
- .2 For painting work in renovation or repair jobs, provide prime and finish coats from corner to corner and from floor to ceiling of affected walls.

### .3 Interior Ceilings

- .1 Ceilings within tenant units shall be finished with painted gypsum board. Exposed ceilings in concrete buildings should be smooth finished and painted.
- .2 Common Area ceilings shall be finished with painted gypsum board where possible. Where T-bar or acoustic tile ceilings are unavoidable, to provide access to building services, they should be limited to common areas and corridors which are easily supervised by building staff.
- .3 Ceilings should have a minimum height of 2440 mm (8'-0") above the finished floor.

### .4 Floor Finishes

#### .1 Dwelling Units

- Provide resilient sheet flooring throughout. Low maintenance, no wax and non-glare finishes are required.
- For family projects: direct glue-down carpets may be considered within the living and bedroom areas as an alternative to resilient sheet flooring.
- Bathrooms: slip-resistant resilient sheet flooring.

## .2 Tenant Common Areas

- Common areas (such as corridors and lounges) used by residents shall be finished in low maintenance, no wax and non-glare resilient sheet flooring.
- High traffic areas such as entrance lobbies may be finished with slip resistant ceramic tile.
- Office and other spaces used by staff shall be finished in resilient sheet flooring, level loop direct glue down carpets or carpet tile.

## .3 Common Laundry, Assisted Bathing Rooms, Commercial Kitchens and Common Washrooms

Provide non-slip safety flooring sloped to a clampable floor drain complete with flash cove wall base.

## .4 Utility Rooms

Storage rooms and service rooms within the finished floor area shall be finished in resilient sheet vinyl or paint on concrete.

## .5 Baseboards

- For tenant suites: 19 mm x 89 mm (3/4" x 3 1/2") painted solid wood baseboard
- For common areas: 19 mm x 140 mm (3/4" x 5 1/2") painted solid wood baseboard
- Avoid the use of MDF baseboards
- For common laundry, assisted bathing rooms, commercial kitchen, janitorial closets: 140mm (5 1/2") flash coved base
- For service or utility rooms: standard resilient base
- To prevent insects and bed bugs from getting behind the baseboard and wall, place a continuous full bead of sealant along the joint between the drywall/wall sheathing and the floor finish. After installation of the wood baseboard, install provide a continuous full bead of sealant along the joint between the floor finish and the baseboard and at the top edge of the baseboard.

## .6 Stair Treads, Risers and Nosings

Where resilient stair treads, risers and nosings are considered for common areas of the project, incorporate detectable warning strips at the top of stairs and visually contrasting nosings on each tread as required by applicable codes.

Refer to [Construction Standards, Division 09 68 00 – Carpet](#) and [Division 09 65 00 – Resilient Flooring](#) for more detailed requirements.

## 7.3 DOORS

### .1 General

- .1 Provide at least one automatic door opener with push buttons at the main entrance to the building and at the entrance to the underground elevator lobby.
- .2 For renovation/ capital improvement and conversion projects, the configuration of existing

doors, opener sizes and sill heights should be reviewed to ensure that these meet current code requirements.

.3 Provide level or roll-over thresholds (flush or bevelled) at all doors, including **balcony doors for accessible units. All balcony doors for assisted living seniors projects, or projects with a combination of assisted living and independent seniors, shall have level or roll-over thresholds.** Thresholds shall be no more than 13 mm (1/2") high, with bevelled edges with a slope **not steeper than a ratio of 1:2 (50%)**. Refer to [SAFERhome Standards Manual](#) for the details on exterior flush threshold to ensure water tightness.

.4 Commercial grade lever door handles are to be installed throughout.

Refer to [Construction Standards, Division 08 70 00 - Finish Hardware](#) for more detailed requirements.

.5 Doorways in the accessible path of travel with a clear opening width not less than 865 mm (2'-10") throughout the building.

.6 Refer to [1.8 Wheelchair Accessible doors](#) for additional information.

## .2 Exterior and Suite Entry Doors

.1 All exterior and suite entry doors must be 915 mm (3'-0") minimum for all type of projects.

.2 Provide all exterior doors with weather protection consisting of a roof overhang or canopy extending past both door jambs.

.3 For exterior doors, provide a detail for the framing or forming at the sill to achieve a roll-over threshold while providing for good waterproofing at the door sill.

## .3 Seniors, Wheelchair Accessible Units and Adaptable Units

.1 In wheelchair accessible units, all suite interior doors shall have a minimum leaf width of 915 mm (3'-0").

.2 In seniors and adaptable units, at least one bathroom and one bedroom doors shall have a minimum leaf width of 915 mm (3'-0"). The minimum width of all other interior door leaf and access to common living areas inside the suites must be 865 mm (2'- 10").

.3 Suite entry door closers – provide low resistance, delayed action closers. Consider swing-free electronic closers in seniors units where the clients may have difficulty with standard door closers. Rough-in for **power-operated** door opener for future upgrade.

.4 Easy access to the bathroom in case of an emergency is required. **Bathroom doors shall swing out.** Sliding pocket doors with D-pulls are acceptable.

.5 Avoid sliding exterior doors.

Refer to [Section 1.8 Wheelchair Accessible and Adaptable Dwelling Units](#) for additional information.

## .4 Other Interior Doors

.1 Except as noted above, the minimum width of all other interior door leaf width must be 865 mm (2'-10").

.2 Provide bypass doors for all closets 1200 mm (4'-0") or wider. Provide bi-fold or swing doors

(preferred) for all closets less than 1200 mm (4'-0") wide.

#### **.5 Common Area Doors**

- .1** Maximize glazing in doors in public corridors including doors at laundry rooms, fire separations, exit stairs and **staff** common areas as permitted by code, to enhance building security.
- .2** All doors in residential amenities, administration/program support, service and common areas should have a minimum leaf width of **915 mm (3'-0")**. Latch side clearance should be met as specified above.

### **7.4 WINDOWS, SIDE HINGED AND SLIDING GLASS DOORS**

#### **.1 General**

- .1** Windows are a critical component in the energy performance of a building. Careful attention must be paid to the selection of window systems. Carefully selecting window-to-wall ratios for different orientations, choosing adequate shading devices and utilizing good thermal and visual transmittance characteristics are important passive design strategies.
- .2** The performance of the fenestration products shall be based on AAMA/WDMA/CSA 101/I.S.2/A440, NAFS – North American Fenestration Standard/Specification for windows, doors and skylights and CSA A440S1, Canadian Supplement to AAMA/WDMA/CSA 101/I.S.2/A440, “NAFS – North American Fenestration Standard/Specification for windows, doors and skylights”. Refer to [Construction Standards, Division 08 50 00 – Windows, Side hinged & Sliding Glass Doors](#) for detailed requirements for the minimum performance ratings for windows for a project.
- .3** Windows must be easily operable by persons with limited strength and dexterity.
- .4** For new construction projects, provide casement or awning windows.
- .5** For renovation/ capital improvement and conversion projects:
  - Review the configuration of existing windows, opener sizes and sill heights to ensure these meet current codes.
  - Provide casement and awning windows. Where the operable unit creates a potential hazard in walking areas, sliding windows can be used.
- .6** When design permits, provide windows in stairways and corridors to introduce natural lighting.
- .7** Review the design and location of operable windows to address code requirements, security issues and the risk of falls. **Provide natural ventilation and optimize window design to maximize ventilation rates. Options could include use of tilt and turn, low and high level operable windows, sill heights to allow larger opening (ensure this meets current building code requirements, safety and accessibility) to increase ventilation rates.**
- .8** Provide window restrictors where requested by the Owner or as required by Code.
- .9** Do not locate windows in bathtub or shower enclosures.
- .10** Avoid the use of skylights in projects.

- .11 Install at least one operable window per unit and one per common area that can be used for ventilation in the case of a power outage. Consider having two operable windows in each unit to facilitate cross ventilation.
- .12 Install window frames that minimize thermal bridging. (i.e. wood, vinyl, fiberglass, or thermally broken aluminum).

## .2 Acoustic Considerations

For projects where an acoustic study has been prepared to address road, rail or other sources of noise, review the study to confirm any recommendations for window specifications and other mitigation measures.

## .3 Window Cleaning

Windows shall be easily accessible for exterior cleaning. Where windows cannot be cleaned from the inside, ensure that provision is made for outside cleaning access. For windows above four floors that cannot be cleaned from grade level, roof top window washing anchors may be necessary. Roof design should consider the requirements for anchors, location and total number. Review with window anchor system supplier prior to Tender to ensure adequate coverage.

## .4 Window Coverings

- .1 Provide drapes or blinds for all exterior windows. The choice of window treatment shall be made by the Owner.
- .2 For renovation projects, review the dimensions of existing window coverings to determine if these are compatible with the new completed work. Installation of new window coverings may be necessary.

## 7.5 EXTERIOR FINISHES

### .1 General

- .1 The choice of exterior finishes should consider minimizing capital, maintenance and replacement costs without compromising the performance of the building envelope.
- .2 Refer to [Construction Standards](#) for detailed requirements for roof and exterior wall finishes.

### .2 Roofing

- .1 Roofing design and installation shall meet the requirements of the 10-year Guarantee Certificate of the Roofing Contractors Association of BC. Refer to [Division 07 31 13 - Asphalt Shingles](#) or [Division 07 50 00 - Membrane Roofing](#) for warranty requirements.
- .2 Acceptable roof finishes include:
  - Asphalt Shingles
  - 2 ply SBS roof membrane
  - Other roof systems and finishes may be considered if prior approval is obtained from BC Housing and the RCABC.

- .3 Provide simple roof designs that address the high levels of precipitation in coastal regions and snowfall in interior and northern regions.
- .4 Ensure that roof drainage is designed to avoid ice damming and to prevent rainwater runoff or snow shedding onto pedestrian pathways.
- .5 Ensure easy access to all roof levels from within the building for roof maintenance. Provide a lockable, insulated roof access hatch. Access to small roof areas by an exterior ladder is acceptable if access from the interior is not convenient and not more than 2 storeys from grade. Providing roof access from within suites is not acceptable. **Provide stair access when mechanical equipment is located on the roof for ease of future maintenance.**

### .3 Exterior Wall Cladding

- .1 All exterior wall cladding should be designed with a rainscreen or a drained cavity system, except in geographical locations, exposure conditions and building form where this may not be necessary. Review with building envelope consultant and refer to the BC Housing Building Enclosure Design Guide, Wood-frame Multi-unit Residential Buildings for best practice guidelines.
- .2 Acceptable wall finishes include:

#### **For wood frame buildings:**

- Fiber cement siding
- Masonry units
- Metal panels
- Vinyl Siding

#### **For non-combustible and high rise buildings:**

- Metal panels
- Masonry units
- Pre-cast concrete panels
- Curtain wall systems - subject to capital budget and project energy targets
- Fire rated composite panels - subject to capital budget consideration

Other finishes may be considered if reviewed and accepted by BC Housing and a building envelope professional.

## 7.6 OPERATING CONTROLS

- .1 Operating controls shall be installed with the centreline between 400 mm to 1200 mm (1'-4" x 4'-0") from the floor.
- .2 Controls shall be operable with one hand, without tight grasping or pinching and with force not exceeding 22N; visual displays shall be colour contrasted and on a glare-free surface.
- .3 Operating controls and fixtures shall have a clear accessible floor space of at least 1350 mm x 800 mm (4'-5" x 2'-8") center in front of the fixture.

- .4 Provide operating controls with visual, tactile and/or auditory information where required
- .5 Provide backing to support wall and ceiling mounted operable fixtures and mounted accessories.

## 8

# Wheelchair Accessible and Adaptable Dwelling Units

## 8.1 GENERAL

All common areas in and around the buildings must be designed to allow universal access. In addition, projects shall be designed to include units modified for wheelchair accessibility. For new construction, it is required to develop at least 5% of the total units as wheelchair accessible. Review with Owner.

Depending on the municipality and need and demand study in the community, this number may increase to accommodate more wheelchair accessible units in a project. Unit areas may be increased by up to 12% to accommodate wheelchair accessibility.

## 8.2 WHEELCHAIR ACCESSIBLE UNITS

### .1 General

Wheelchair accessible units shall be designed in accordance with all applicable Building Codes.

Reference shall also be made to [CSA B651-12](#) Accessible Design for the Built Environment for design guidelines not covered by Code.

### .2 Circulation

.1 Provide a clear 1500 mm (5'-0") turning radius:

- inside and outside of suite entrance doors
- inside the bedroom, and a clear floor area of at least 750 x 1200 mm (29.5" x 4'-0") to at least two sides of the bed
- inside the bathroom, (radius to be clear of all cabinets and fixtures)
- inside the kitchen (radius to be clear of all cabinets and fixtures)
- Clothing closet shall have a accessible maneuvering space of at least 750 mm x 1200 mm (2'-6" x 4'-0") in front.

.2 Provide a 920 mm (3'-0") minimum clearance for circulation throughout the unit with no steps or level changes.

### .3 Unit Entrance Weather Protection

Provide weather protection at the primary unit entrance if accessed directly from the outside.

### .4 Doors

.1 Doors and doorways shall have accessible maneuvering space on either side of the door swing. Door latch swing towards the person shall have a minimum clear level floor space of 600 mm x 1500 mm (2'-0" x 4'-0") beside the latching door frame. Door latch swing away

from the person shall have a minimum clear level space of 300 mm x 1200 mm (1'-0" x 4'-0") beside the latching door frame.

- .2 Commercial grade lever door handles are to be installed throughout the dwelling unit.
- .3 Install low resistance, delayed action closers for all doors on accessible routes, including suite entrance doors.
- .4 In projects with wheelchair accessible units, consider the use of kick plates at least 250 mm (10") high on the push side of doors in high traffic areas to prevent doors from damage.
- .5 Two door viewers to be provided at standard height 1625 mm (5'-4") and at an accessible height between the range of 1000 mm and 1200 mm (3'-3" and 4'-0") from the floor.
- .6 Doors to swing out (or be pocket doors) at bathroom/ washroom, roll-in closets and general storage.

## .5 Windows

- .1 Windows should be designed so that the sill is no more than 750 mm (2'-6") above the floor.
- .2 Ensure that hardware for operable portions of windows are not more than 1067 mm (3'-6") above the floor. Provide window restrictors where required by Code or requested by Owner. Provide a clear accessible floor space in front at 1350 mm x 800 mm (4'-5" x 2'-8") centered.

## .6 Kitchen

Provide L-shaped configurations wherever possible. All controls in the kitchen should be in an accessible location. Provide a clear floor area of 750 mm x 1200 mm (2'-6" x 4'-0") directly in front of fixtures and appliances and on one side of open drawers and cabinets.

### .1 Cabinets

- .1 Provide a counter height between 810 mm to 860 mm (2'-8" to 2'-10") high from the floor.
- .2 Provide at least one work surface that is 760 mm wide x 600 mm deep (2'-6" wide x 2'-0" deep), with a centred knee clearance at least 760 mm wide x 500 mm deep x 685 mm high (2'-6" wide x 1'-8" deep x 2'-3" high).
- .3 Provide a knee clearance centred on the cook top at least at least 750 mm wide x 480 mm deep x 680 mm high (2'-6" wide x 1'-6" deep x 2'-3" high) from the floor with an additional toe space at least 760 mm wide x 250 mm deep x 250 mm high (2'-6" wide x 10" deep x 10" high).
- .4 Provide a pull-out heat resistant work surface with hardwood or plastic laminate top below the counter and an additional pull-out shelf below the wall oven.
- .5 Provide full-extension pull-out shelves with minimum 40 mm (1.6") raised edges or drawers on free-rolling mechanical slides rather than fixed shelving in base cabinets.
- .6 Provide a base cabinet toe space of 150 mm deep x 250 mm high (6" deep x 10" high).
- .7 Cabinet doors shall be provided with easily graspable D-type door pulls, and shall be within 400 mm to 1200 mm (1'-4" to 4'-0") reaching range.

- .8 Kitchen storage shall have at least one shelf in cupboards no more than 1100 mm (3'-7") high from above the floor.
- .9 Kitchen countertop work surfaces shall be illuminated to a level at least 300 lx.

## .2 Kitchen Sink

- .1 Provide a double bowl stainless steel sink, complete with insulated hot water supply, insulated off-set drain, and single lever faucet.
- .2 Provide a knee clearance centered on the sink at least 760 mm wide x 250 mm deep x 685 mm high (2'-6" wide x 10" deep x 2'-3" high) with an additional toe space at least 760 mm wide x 250 mm deep x 685 mm high (2'-6" wide x 10" deep x 2'-3" high). Front of sink shall have at least 750 mm x 1200 mm (2'-6" x 4'-0") clear floor area which may extend up to 480 mm (1'-8") underneath the sink.

## .3 Appliances

- .1 Appliances in wheelchair accessible units should include the features as noted below:
  - .1 Dishwasher: front loading, ENERGY STAR® rated porcelain liner.
  - .2 Refrigerators: frost free; ADA compliant ENERGY STAR® rated top freezer refrigerators with all controls not more than 1200 mm (4'-0") above finished floor and allow one-hand operation. Provide a refrigerator with top mount freezer with bottom shelf no more than 1100 mm (3'-7") from the floor, or a side by side refrigerator/freezer.
  - .3 Cooktop: four elements, front controls mounted on front panel, no more than 1200 mm (4'-0") high from the floor. Provide a clear floor space of at least 750 mm x 1200 mm (2'-6" x 4'-0"), a countertop work surface at least 400 mm (1'-4") wide adjacent to cooktop at the same height and minimum knee and toe clearance space.
  - .4 Range hood: two speed range hood with light and fan controls mounted on the front of the counter, ENERGY STAR® rated. Obtain on-site CSA approval if required.
  - .5 Wall Oven: Provide an energy efficient wall oven with side opening swing door, self cleaning feature optional, installed at 700 mm to 840 mm (2'-4" to 2'-9") from floor to bottom edge, with a pull-out heat resistant shelf beside the oven door or under the oven. Controls to be mounted on front panel, no more than 1200 mm (4'-0") high from the floor.
  - .6 Provide outlets for microwave ovens to be installed at the countertop or lower cabinet.
- .2 Provide convenience outlets, light, and fan controls at locations accessible from seated positions.

## .7 Bathroom

- .1 Provide a minimum maneuvering space, in front of lavatory at least 800 mm x 1350 mm (2'-8" x 4'-5") (up to 480 mm (1'-8") may be under counter), provide top of lavatory height between 810 mm and 860 mm (2'-8" and 2'-10") from above the floor, centerline of lavatory at least 460 mm (1'-6") from side wall.
- .2 Provide a knee clearance centred on the sink at least 760 mm wide x 250 mm deep x 685 mm

high (2'-6" wide x 10" deep x 2'-3" high) with an additional toe space at least 760 mm wide x 250 mm deep x 250 mm high (2'-6" wide x 10" deep x 10" high). Provide a lavatory with single lever faucet, temperature limit stop, insulated hot water supply, and off-set drain.

- .3 Provide a 915 mm x 1500 mm (3'-0" x 3'-5") prefabricated non-slip gelcoat roll-in shower. Make provision for wall-mounted folding seats that will allow lateral transfer from a wheelchair. Review type of seat with Owner. Provide low flow, with pressure balance mixing valves with telephone type shower head on adjustable slide bars.
- .4 Bath and shower control positioning: all controls are offset from centre, roughly 1/2 way between center location and the outside edge of the shower or tub enclosure.
- .5 Provide a clear transfer space at least 900 mm wide x 1500 mm long (3'-0" wide x 5'-0" long) on the open side of the toilet and in front of the shower.
- .6 Provide solidly backed grab bars beside the water closet and in the shower installed in accordance with the current BC Building Code. Grab bars and towel bars shall be designed and installed to withstand a load of 1.3 kN. Towel bars shall be located no more than 1100 mm (3'-7") high from above the floor. Provide support structural to all wall and ceiling with mounted accessories.
- .7 Provide a mirror with bottom edge no more than 1000 mm (3'-3") from the floor.
- .8 Provision should be made to ensure that the bathroom door can be opened in case of emergency. Bathroom doors shall swing out. Sliding pocket doors with heavy duty "D" pulls are also acceptable.
- .9 Provision of a trench drain could be considered in the shower enclosure design. Refer to [SAFERhome Standards Manual](#).
- .10 Provide medicine cabinets with at least 750 mm x 1200 mm (2'-6" x 4'-0") clear floor area; shall be located within a horizontal reach maximum of 500 mm (1'-8"), the bottom of the shelf not more than 1000 mm (3'-3") from above the floor, and illuminated level at least 200 lx.
- .11 Toilet fixture centerline shall be at least 460 mm to 480 mm (1'-6" to 1'-7") from an adjacent wall.
- .12 Toilet seat height shall be between 430 mm and 485 mm (1'-6" and 1'-7") from the floor. Tank lid shall have bolted lids.
- .13 Provide a floor drain with trap primer in all accessible bathrooms.

## .8 Operable Fixtures

All operable fixtures, including cabinet and window hardware, must be accessible and easily operable by persons with limited strength and dexterity. Refer to [Section 1.7.6 Operating Controls](#).

## .9 Storage

Provide for storage closets rather than storage rooms for easy access. Closet widths less than 1200 mm (4'-0") are not recommended.

## .10 Clothes Closets

All clothes closet rods must be adjustable from 1200 mm to 1400 mm (4'-0" to 4'-8") above finished floor.

- Clothing closets shall have a maneuvering space of at least 750 mm x 1200 mm (2'-6" x 4'-0") in front.
- Where shelves are provided, at least 3 shelves shall be between 400 mm and 1200 mm (1'-4" and 4'-0") from the floor

### .11 Electrical Items

- .1 Refer to Article 8.2.3 Electrical in this section for mounting height and outlet placement.
- .2 In bedrooms, in addition to the switched ceiling mounted fixture, provide a three way switched wall outlet adjacent to the bed; one switch at the door to the room, and one adjacent to the proposed bed location.
- .3 Light fixtures must contain two or more bulbs.
- .4 Provide a ground fault current interrupter (GFCI) electrical outlet at the bathroom vanity and kitchen counter, in a location accessible from a seated position.
- .5 General storage room shall provide an electrical outlet inside close to the door and shall be illuminated to a level of at least 100 lx.
- .6 Operating controls shall be installed centerline of the maneuvering space.

## 8.3 ADAPTABLE UNITS

Adaptable units are designed and constructed to facilitate future modification to provide access for persons with disabilities. The requirements for the design of adaptable units are set out in Section 3.8.5 Adaptable Dwelling Units of the BC Building Code. In addition, many municipalities have their own adaptable requirements.

Designing for adaptable units will allow residents to age in place if they desire or allow adaptations in their units to meet possible changes in their physical abilities. The number of adaptable units in projects will be based on the Owner's requirement supported by a need and demand in that geographical location. This will allow flexibility for future access for persons with disabilities at minimal additional cost.

It is required that all suites in multi-unit residential buildings for seniors be designed as adaptable units. Adaptable units shall consider all other design requirements contained in the BC Housing Design Guidelines including the following features below. Where there is a conflict, the more stringent shall prevail.

### .1 Access requirements

- .1 Refer to [Article 4.4 Circulation and Access](#) of this section for exterior and interior access route and other requirements.
- .2 Refer to BC Building Code section 3.8.5 for corridors and passageways providing access to adaptable dwelling units entrances and common facilities.
- .3 The construction of adaptable units and the building in which they are located shall comply with all the other access requirements called for in the BC Building Code and the local municipality.

## .2 Doorways to adaptable dwelling units

- .1 Refer to [Finishes and Materials](#) for door width, latch clearance and other requirements for adaptable units.
- .2 **Doorways at the suite entry and** at least one bedroom and one bathroom shall have a level clearance of **600 mm x 1500 mm (2'-0" x 5'-0")** on the pull side of the door and **300 mm x 1200 mm (1'-0" x 4'-0")** on the push side of the door.

## .3 Adaptable Dwelling Unit Bathrooms and Kitchens

- .1 Bathrooms in adaptable units shall be designed to allow maneuverability and access to the shower, lavatory and water closet by persons using mobility aids such as walkers. Some requirements are:
    - A **915 mm x 1500 mm (3'-0" x 5'-0")** prefabricated **non-slip gelcoat** shower with a **low threshold curb (3"-4")**. Location of the shower fixtures should be easily reached by the people with wheelchairs. Other shower sizes are acceptable if accepted by the Owner and the municipality. **Provide telephone type shower head on adjustable sliding bar.**
    - Position bath and shower controls halfway between the outer edge and the centreline of the tub or shower enclosure to avoid having to lean in and reduce the potential slip and fall accidents.
    - A dimension from the front edge of the toilet to the facing wall of not less than 850 mm (2'-10").
    - A dimension from the front face of the shower to the centreline of the toilet not less than 510 mm (1'-8").
    - Units with bathtub should be designed to allow easy conversion to shower units.
    - A clear floor area in front of the lavatory not less than **760 mm wide x 1220 mm deep (2'-6" wide x 4'-0" deep)**.
    - Provide **38 mm x 286 mm (2" x 12")** solid wood backing for installation of grab bars beside the water closet and around the shower as called for in the current BC Building Code which will resist a vertical and horizontal load of not less than 1.3 kN.
    - Install grab bars as required in the current BC Building Code.
  - .2 Design the kitchen to provide kitchen counter lengths to the requirements called for under [Kitchens and Bathrooms](#). Additional requirements are:
    - the range and sink are adjacent or can have a continuous counter between them. **Provide 900 mm (3'-0")** base cabinet for the kitchen and bathroom sinks which can be removed in the future if necessary to create an open knee space for wheelchair users. Refer to [Kitchens and Bathrooms](#) for lowering waste pipe under sinks.
- ## .4 Electrical
- .1 Refer to Article 8.2.3 Electrical for mounting height and outlet placement.
  - .2 **For seniors, adaptable, and wheelchair accessible units, fire alarm signaling devices in suites shall incorporate visual signals (strobes) in addition to audible signals (buzzers).**

## .5 Window Hardware

Locate hardware for operable windows not more than 1067 mm (3'-6") above the floor.

# 9 Building Systems

## 9.1 BUILDING ENVELOPE

To achieve the sustainability goals outlined in Section 2 - Energy and Environmental Design the project team must work together to achieve high levels of energy performance while minimizing the complexity of mechanical systems. All buildings shall meet or exceed the whole building performance targets identified in Section 2.0. These targets shall be verified through mandatory building and energy modelling as per the Provincial Energy Step Code. These targets should be accomplished by optimizing the building enclosure. This approach will result in a significant increase in the level of required envelope performance and will require careful attention to:

### 1. Massing

The project team should focus on developing as compact a building form as possible.

Buildings with a compact shape, minimal articulation and fewer projections will generally achieve better energy performance.

### 2. Building Orientation

- If possible orient the building facing south so that benefits of solar gain can be achieved.

### 3. Effective Building Envelope Thermal Performance

- Effective building envelope thermal performance shall be calculated in accordance with the Building Envelope Thermal Bridging Guide and shall account for: clear wall heat losses, heat losses through linear interfaces with major components (slab edges, parapets, corners, window perimeters, etc.) and point transmittance heat losses (beams, structural penetrations, anchors, etc.).
- Where the project design team includes the envelope consultant, the consultant should be responsible for calculating the effective building envelope thermal performance.

### 4. Window location, quality and quantity

- Window locations should be carefully planned to maximize daylighting and manage heat loss and gain. Consider adjusting the window size and glazing assembly based on orientation.
- The windows must be carefully integrated into the entire envelope system. Ensure that the air barrier and insulation continuity is maintained at the window / wall interface.
- Windows must meet the applicable NAFS and CSA standards. Refer to [Division 08 50 00 - Windows, Side-Hinged & Sliding Glass Doors](#) for detailed requirements for the minimum performance ratings for windows.
- Fenestration products shall be labeled to show an overall product U-value of  $U \leq 1.4 \text{ W/m}^2\cdot\text{°K}$  ( $0.25 \text{ Btu/h}\cdot\text{ft}^2\cdot\text{°F}$ ) as required by the BC Energy Efficiency Standards Regulation and depending on BC Housing energy target for that climate zone. U-value labels shall bear the mark of a recognized certification agency.

## 5. Solar Shading

Solar shading on the south and west elevations should be investigated to determine whether it can effectively assist in reducing solar gains in the summer.

## 6. Reduction / elimination of thermal bridging

- Thermal bridging through the building envelope can greatly reduce the effectiveness of the envelope performance and should be addressed in the design of the envelope. The consultant will identify and mitigate thermal bridges in designs and details on drawings so the contractor can implement those effectively in construction. Refer to [Building Envelope Thermal Bridging Guide](#) and [Building Enclosure Design Guide-Wood Frame Multi-Unit Residential Buildings](#).
- Thermal bridging should be accounted for in the energy model.
- **Designs with limited articulation and balconies assist in limiting thermal bridging and reducing construction costs. This should be a consideration in building design.**

## 7. Air Tightness

Air barrier shall be continuous and the consultant shall identify the air barrier as a single unbroken line illustrated on drawings including interfaces between dissimilar materials and parts.

Careful inspection of the wall assemblies is required during construction to ensure that the air barrier is continuous and all penetrations are sealed.

All buildings will need to be tested to determine Envelope Air Leakage Rates as airtightness of the building envelope is critical to its performance. Refer to [Energy and Environmental Design](#).

The architect must work closely with the whole team but especially the mechanical engineer, envelope consultants and the energy modeler. The envelope targets can be met by a variety of wall assemblies. They should be explored by the project team to arrive at an optimum solution that meets the energy targets and the project budget. Some assemblies to consider are:

- Split Insulated Walls
- Exterior Insulated Walls
- Double Stud Walls
- Deep Stud Walls
- Structurally Insulated panels

As insulation and air barriers must be continuous, careful detail attention during design and construction will be required at all transitions. These include:

- Basements
- Headers and Rim Joists
- Roof to Wall Transitions
- Interior wall to exterior wall junctions
- Window and door jambs
- Penetrations through the envelope (Balconies, decks, ducts, electrical outlets, structural anchors, etc.)

### Design Guides

- Illustrated Guide - Energy Efficiency Requirement for Houses in British Columbia published by BC Housing (Available at [bchousing.org](http://bchousing.org))
- Guide for Designing Energy-Efficient Building Enclosures for Wood-Frame Multi-Unit Residential Buildings published by FP Innovations, BC Housing, and the Canadian Wood Council (Available at [www.fpinnovations.ca](http://www.fpinnovations.ca))
- Building Envelope Guide for Houses published by BC Housing (Available at [bchousing.org](http://bchousing.org))
- Building Enclosure Design Guide published by BC Housing (Available at [bchousing.org](http://bchousing.org))
- Canadian Home Builder's Association Builder's Manual published by the Canadian Home Builder's Association (Available at [www.chba.ca](http://www.chba.ca))
- Canadian Wood-Frame House Construction published by the Canada Mortgage and Housing Corporation (CMHC) (Available at [www.cmhc-schl.gc.ca](http://www.cmhc-schl.gc.ca))
- Residential Construction Performance Guide published by BC Housing (Available at [bchousing.org](http://bchousing.org))
- Builder's Guide to Cold Climates published by Building Science Corporation (Available at [www.buildingsciencepress.com](http://www.buildingsciencepress.com))
- Pathways to High-Performance Housing in British Columbia published by FPInnovations (Available at [www.fpinnovations.ca](http://www.fpinnovations.ca))
- Building Envelope Thermal Bridging Guide (Available at <https://www.bchydro.com/powersmart/business/programs/new-construction.html#thermal>)
- R22+ Effective Walls in Wood-Frame Construction in British Columbia (Available [bchousing.org](http://bchousing.org))
- Refer to [Illustrated Guide - Achieving Airtight Buildings](#)

## 9.2 ELEVATORS

Elevators should be located in a location that compliments the function and traffic flow of the building; ideally within the main entrance lobby of the building and visible from the main entrance. Where a group of elevators is provided, the group must be arranged to minimize walking distance among or between the elevators. For group of elevators, all elevators shall serve the same floor levels including parking levels if applicable.

The elevator design shall meet the current standards for operation, reliability, performance, safety, accessibility and to reasonable standards of cleanliness and appearance. The location, type, number, size and speed of elevators shall be determined using elevator analysis calculations and simulation techniques. The buildings covered by this section will be predominantly residential in use and typically exhibit traffic patterns that are more intense than typical residential buildings. Analysis shall be performed by an experienced Elevator Engineer or Consultant.

For existing elevators in buildings that are renovated or converted for other uses shall be upgraded or replaced shall meet the current standards as mentioned above and include the necessary scope to meet the technical requirements of [Construction Standards, Division 14 20 00 - Elevators](#). The size, location and speed of existing elevators can remain unchanged in most instances unless these are deemed inappropriate for the on-going use and operation in the building.

For renovation projects, consideration should be given to replacing hydraulic elevators that use in-ground buried hydraulic cylinders with traction elevators of the Machine-Room-Less (MRL) type as

an alternative to merely upgrading the hydraulic elevator and its components.

The following design criteria shall be reviewed to confirm the elevator requirements for the project:

### .1 Elevator Location

- .1 Elevators should be conveniently located in the main entrance lobby and in close proximity to the geometric centre of the building to allow balanced access to all parts of the building.
- .2 For most projects, it is recommended that the distance from the farthest suite or room to the elevator(s) should not exceed 45 m (150ft). For seniors projects, it is recommended that the distance from the farthest suite or room to the elevator(s) and nearest exit does not exceed 30 m (98'-5").

### .2 Elevator Group Arrangement

- .1 Elevators should be grouped, avoid single elevators in various parts of the building. Where two or more cores of elevators are provided in separate parts of the building, then each group must have additional capacity to account for the possible imbalance in the traffic between the groups.
- .2 Where two elevators are provided in a group the cars should be arranged side by side with no separation between the hoistways.
- .3 Where three or four elevators are provided in a group the cars should be arranged side by side in a row or two side by side opposite the other(s).
- .4 Larger groups of elevator should have a maximum of 4 cars in a row side by side.

### .3 Type of Elevator

- .1 The elevator analysis should determine the appropriate type of the elevators to provide good elevator service and should be selected from the following table for any given buildings. The minimum rated speed shown in the table shall be used as a guide only:

ELEVATOR SELECTION CRITERIA		
Number of Floors Above Ground	Type of Elevator Equipment	Minimum Rated Speed
4 Floors or less	Machine Room-Less Traction	150 fpm
5 - 10 Floors	Conventional or Machine Room-Less Traction	200 fpm
11 - 24 Floors	Conventional or Machine Room-Less Traction	250 fpm
25 - 30 Floors	Conventional Traction	500 fpm
30 + Floors	Conventional Gearless Traction	700 fpm

- .2 Other types of elevating devices such as Lifts for Persons with Disabilities, Wheelchair Platform Lifts and Limited Use Limited Application (LULA) elevators shall not be used in place of a true elevator. The building shall be designed such that additional lifts of this nature would not be required.

### .4 Number of Elevators

- .1 Where the building is 6 or more storeys in height, or intended for seniors, or the accessible

units are not in the main floor of the building, there should be at least two (2) elevators to ensure that elevator service is available at all times for the safety and convenience of tenants.

- .2 For supporting housing projects (additional supports and program space provided), passenger demand in buildings of this nature may be more constant and prolonged than in typical residential buildings and this should be taken into consideration when determining the elevator requirements.

## .5 Building Residents and Performance of Elevators

- .1 Population density varies depending on the anticipated tenancy and the following table shall be used as a guide when selecting the figures for calculating the elevator requirements. The performance (interval and waiting time) should be targeted as maximum. Due to the nature of the buildings and tenancy, the inefficiency in the use of the elevators may be somewhat greater than in typical buildings and the following inefficiency values shall be used in the calculations.

BUILDING POPULATION AND USE CRITERIA			
Type of Tenancy	Population Density (persons per bedrooms)	Inefficiency Factor	
Studio	1.0	10%	
Seniors	1.2	25%	
Families	1.8	20%	

ELEVATOR SYSTEM PERFORMANCE CRITERIA			
Type of Tenancy	Minimum 5 Minute Handling Capacity as a Percentage of Total Building Population	Maximum Lobby Interval (for Up Peak traffic periods)	Maximum Average Waiting Time (for Two Way traffic period)
Studio	10%	50 seconds	30 seconds
Seniors	7%	50 seconds	40 seconds
Families	7%	50 seconds	30 seconds

- .2 Passenger demand in buildings of this nature may be more constant and prolonged than in typical residential buildings and this should be taken into consideration when determining the elevator requirements

## .6 Capacity and Size of Elevator

- .1 Elevators shall be of minimum dimensions to provide access for persons with disabilities and to accommodate a mobile stretcher in the prone position or as otherwise required by the governing codes and regulations. A standard 1134 kg (2500 lb) passenger elevator with a 1067 mm (3'-6") single panel side opening door is the minimum size of elevator acceptable. Where other door dimensions or configurations are contemplated, the platform and cab inside dimensions shall be adjusted to meet the stretcher requirements.
- .2 The elevator shall have internal cab dimensions no less than 2032 mm wide x 1295 mm deep (6'-8" wide x 4'-3" deep).
- .3 For buildings intended for seniors or other persons with impaired mobility the minimum size elevator should be increased to a standard 1600 kg (3500 lb) passenger elevator with internal dimensions no less than 2032 mm wide x 1650 mm deep (6'-8" wide x 5'-5" deep).

- .4 Service elevators provided for the movement of goods and materials, beds or for longer term care purposes should be hospital / service shaped elevators with minimum 2045 kg (4500 lb) capacity rating, 1220 mm (4'-0") wide doors and 2410 mm (7'-11") cab depth
- .5 All elevator cabs should have a clear height inside of not less than 2590 mm (8'-6") below the cab ceiling or suspended light fixture for ease of moving furniture. Alternate ceiling heights may be acceptable. Review requirements with Owner.

#### **.7 Traffic Pattern**

- .1 Analysis should consider the traffic pattern and perform for both traditional up peak traffic periods and for two way traffic periods to provide the anticipated demand on the elevators. For example, meal time may place the highest demand on the use of the elevators and where centralized dining facilities are used that rely on transporting tenants to and from the dining areas the peak traffic created by such movement should be utilized in determining the elevator requirements.
- .2 If secondary entrances from parking areas, walkways, tunnels or other areas are located at levels other than the main lobby level, the impact of such entrances on the elevator traffic patterns must be taken into consideration.

#### **.8 Location of High Traffic area**

- .1 The location of high traffic areas of the building such as lounges, laundry facilities, gardens, mail rooms and other amenity rooms must be taken into consideration when calculating the elevator requirements. If these areas are located at levels other than the main lobby level, their impact on the elevator traffic patterns should be taken into consideration when calculating the elevator requirements.

#### **.9 Lobby Size**

- .1 The size of the main lobby area must allow for the loading, unloading and queuing of passengers and other goods or materials that will be transported by the elevators. The lobby width should not be less than 3.0 m (10'-0") in width.
- .2 Where a single elevator is provided, the lobby width at typical floors shall not be less than 1.5 m (5'-0").
- .3 Where a group of elevators is provided, the lobby width at typical floors shall not be less than 1.8 m (6'-0") where the elevators are side by side and not less than 2.7 m (9'-0") where the elevators are opposite.

#### **.10 Machine and/or Control Room Location**

- .1 Control rooms for Machine-Room-Less traction elevators should be located adjacent to the elevator hoistway at or near the top landing of the elevator(s). Control spaces that do not permit full body entry into the space containing the control equipment shall not be provided. Remote control rooms should only be provided when suitable space is not readily available adjacent to the top elevator landing or hoistway overhead area.
- .2 Conventional traction elevator machine rooms shall be located directly overhead of the hoistway unless Municipal zoning height restrictions apply.
- .3 The elevator hoistway and machinery areas shall be isolated from residential rooms in the

building with mechanical shafts, stairwells or corridors where possible. If the hoistway or machinery areas must be adjacent to residential rooms, then the wall shall have an effective minimum sound transmission rating of STC 55. This will require a wall assembly rated at STC 60.

#### .11 Elevator Fire and Life Safety Features

- .1 Elevators shall be equipped with Firefighter's Emergency Operation Phase I & II as defined by the B44 Elevator Safety Code and as a minimum regardless of whether these features are required by the building code or not. Provide automatic recall, alternate floor recall, machine room smoke sensor recall and recall by hoistway or pit fire detectors (if applicable) all in accordance with the B44 Elevator Safety Code.
- .2 Elevator emergency power operation need only be provided for "high" buildings as defined by the applicable building code and for any elevators that are designated for use by Firefighters.

Refer to [Fire and Life Safety Measures](#) and [Division 14 20 00 - Elevators](#) for technical requirements.

### 9.3 BUILDING AND ENERGY PERFORMANCE, MECHANICAL AND ELECTRICAL SYSTEMS

#### .1 Building and Energy Performance

- .1 All buildings shall meet the current BC Housing Design Guidelines and Construction Standards and the re-zoning and energy by-law requirements of the Municipalities Having Jurisdiction. Projects are required to exceed the minimum mandatory requirements and achieve higher energy efficiency and sustainability targets where BC Housing requirements are more stringent.
- .2 The building performance and energy efficiency targets established for the project shall move away from the "**Prescriptive Approach**" and the "**Reference Building Approach**" to the "**Target Based Approach**". These targets shall be aligned with the Energy Step Code introduced and implemented through revisions to the Vancouver Building By-law and the British Columbia Building Code.
- .3 The intention is to reduce the reliance on mechanical and electrical systems generating heating and cooling energy and adopt more passive design strategies and a better building envelope to maximize occupant comfort and minimize energy use. Refer to [Energy and Environmental Design](#).
- .4 The minimum Performance Targets for all new BC Housing projects shall be as per Energy and Environmental Design section.
- .5 The actual Envelope Air Leakage Rate shall be confirmed through a mandatory testing performed in accordance with the requirements of the Provincial Energy Step Code. Airtightness of suites is to be tested and reported for residential buildings and must demonstrate compliance with a suite-level air-leakage target as tested to ASTM E 779 or equivalent standard. The air tightness testing result shall be submitted by the Contractor at substantial completion. The sample set shall require testing of at least 10% of total units and be representative of the variety of unit types in the building.
- .6 The Energy Targets shall be verified through a mandatory building and energy modelling as

described in the Provincial Energy Step Code, performed by an experienced Energy Modeler hired by the Owner/Consultant. Energy modelling shall be performed in all type of BC Housing projects and results shall be submitted to the Owner and development team during schematic design stage. Any changes as the drawings and specifications progress that may impact energy performance shall require submission of a recalculated energy model.

## .2 Heating, Ventilation and Air-conditioning (HVAC) Systems

- .1 The HVAC systems in multi-unit residential buildings more than three-storeys shall be designed to meet all applicable requirements of **the valid edition of ASHRAE** Standard 90.1 “Energy Standard for Buildings Except Low-Rise Residential Buildings” and the BC Building Code or Vancouver Building By-law for Part 3 buildings, including all additional re-zoning and energy by-law requirements of the Municipalities Having Jurisdiction for Part 3 buildings.

Multi-family buildings of three storeys or less shall be designed to meet all applicable requirements of the BC Building Code or Vancouver By-law for Part 9 buildings, including all additional re-zoning and energy by-law requirements of the Municipalities Having Jurisdiction for Part 9 buildings.

- .2 Passive design strategies and a better performing building envelope shall be chosen ahead of utilizing complex and difficult to operate/maintain HVAC systems. The servicing and maintenance capabilities of the societies operating the building shall be taken into consideration in choosing the type of mechanical systems. The strategies of harnessing solar radiation and capturing internal heat gains for heating, using enhanced natural ventilation and utilizing natural and mechanical ventilation overnight to cool the warm building structures shall be considered.
- .3 **Special attention shall be paid to summer overheating of residential suites. For buildings that do not incorporate full mechanical cooling for residential suites, the building modelling shall demonstrate compliance with City of Vancouver Energy Modelling Guidelines Thermal Comfort requirements. Refer to [Section 2 2.1.3 Thermal Comfort Evaluation](#).**
- .4 Ventilation of residential suites shall comply with the requirements of Part 9 “Housing and Small Buildings”, Section 9.32 “Ventilation” of the BC Building Code or Vancouver Building By-law. This applies to all Part 3 and Part 9 buildings.
- .5 All major ventilation systems shall include heat recovery with a minimum sensible heat recovery effectiveness of 75%. Option of air bypass or other means of stopping heat transfer should be considered for all heat recovery systems to utilize shoulder season or summer night time cooling. Wherever practically possible, all Part 3 buildings should be provided with a central HRV system or systems.
- .6 All new construction and major renovation projects for Part 3 buildings shall be provided with a full 2 years warranty for the mechanical systems. In addition, full 2 years of a service and maintenance contract for the mechanical systems, including controls, shall be provided by the mechanical contractor. Part 9 buildings shall be provided with a full 1 year warranty and service / maintenance contract.
- .7 The Consultant shall ensure that any applicable rebates and incentives programs available from the local Utility Providers and Public Agencies for implementing energy efficient designs are included and captured in all projects.

.8 Refer to [Energy and Environmental Design](#).

### .3 Plumbing Systems

- .1 Provide water efficient plumbing fixtures including low flow shower heads and faucets and low-flush water closets. Refer to [Construction Standards, Division 22 - Plumbing](#) for maximum allowed flow rates of plumbing fixtures.
- .2 Domestic hot water temperature must not exceed 49°C (120°F) at points of use by tenants. Refer to [Construction Standards, Division 22 - Plumbing](#) for domestic hot water anti-scalding requirements.
- .3 Water supply piping in exterior walls is not permitted unless it is installed in a furred-out chase on the warm side of the wall. Do not embed piping in the wall insulation. Any in-slab distribution of potable water piping, if considered, shall be contained within an individual residential suite.
- .4 Avoid plumbing within party walls. Provide chases as required to avoid this condition. If plumbing within party walls is unavoidable, engage the services of an acoustical consultant to provide design, site inspection and testing services to ensure STC55 is achieved in party walls.
- .5 Avoid sump pumps for storm and sanitary wherever gravity drain connections are possible.
- .6 Provide restricted access to manifolds within the units for **projects with at-risk clients** (e.g. shelter or **homeless at risk** projects)

### .4 Electrical

- .1 Mount light switches, thermostats and other controls at 1067 mm (3'-6") from the finished floor to the center of the outlet or control box. Locate convenience outlets no lower than 455 mm (1'-6") above finished floor to the centerline of the outlet.
- .2 Exterior and interior circulation routes/space, within dwelling units, common service areas and entry areas operating controls shall be illuminated to a level of at least 100 lx.
- .3 Dwelling unit kitchen countertop operating controls shall be illuminated to a level of at least 300lx.
- .4 Emergency lighting shall be illuminated to a level of at least 50 lx.
- .5 Signage lighting shall be illuminated to a level of at least 200 lx.
- .6 Provide an electrical outlet near all bedroom windows (for future curtain controls), top or bottom of the stairs (for future stair gliders) and above suite entry doors (inside - for future door opener) for seniors and wheelchair accessible units.
- .7 Consideration should be given to installing a 4-plex convenience outlet on each side of the bed of master bedroom to avoid the use of extension cords and potential fire hazards.
- .8 If possible, place an electrical outlet on a side wall beside a counter to make it easier for those people who cannot reach the back.
- .9 Provide tamper-proof sensors/thermostats in the units for **projects with at-risk clients**.
- .10 Emergency generators will be required for the following projects:

- Those specifically designated by BC Housing as an Alternate Work Site, Emergency Operations Centre, Reception Centre or Group Lodging Facility;
- Housing for seniors or persons with disabilities where prolonged power outages could present a safety or major mobility issue.
- Provision of emergency generators can also be considered on the basis of need. This includes projects where local conditions or remoteness of location could affect the operation of the project or needs of the residents during prolonged power outages.
- This requirement shall be confirmed with BC Housing and the Owner/Operator.

Review [Section 4 Division 26 Electrical](#) for additional information.

## .5 Metering

- .1 Design metering to meet the operational requirements of the project and in compliance with the metering requirements of the utility provider. These requirements should be clearly stated at the start of the design phase.
- .2 Typically, independent metering is to be provided for each of the following areas:
  - **Electricity:** separate BC Hydro or Fortis Electric meters for residential areas, common areas, lease spaces and common lease space. Each residential unit shall be provided with a meter base for future individual metering.

Refer to BC Hydro metering requirements on their website.

- **Gas:** separate meters for residential areas, common areas and lease spaces.
- **Water:** A total building water meter shall be provided. Where applicable, provide separate water sub-meters to areas with separate lease agreements. Confirm requirements for water sub-metering with BC Housing.

## .6 Security Systems

- .1 The Consultant shall review security issues at the design development stage and incorporate cost effective security systems, subject to review by the Owner and BC Housing. The technical requirements for these systems shall be identified during the design stage to allow for coordination and inclusion in the contract documents.
- .2 Security measures may include access control systems, surveillance systems and security alarms, based on a threat and risk assessment, and in accordance with CPTED principles. Related costs must be identified prior to project commitment.

Refer to [Construction Standards, Division 27 00 00 Communications](#).

For shelter or **homeless at-risk** projects, the security cameras **must cover** the typical locations including all exit and entry doors, all common hallways, exit stairs, common areas, exterior parking and any exterior storage areas. The camera monitors shall be located in the front entry office. Refer to [BC Housing Shelter Guidelines](#).

For supportive housing where 24/7 direct support services are provided to **homeless at-risk** clients, the minimum design requirements are outlined in Section 4. Refer to [Construction Standards, Division 27 00 00 - Communications](#).

## .7 Personal Call Systems

For assisted living projects, equipment and wiring for a personal call system shall be installed in the common areas. Electrical outlets and telephone jacks shall be provided in the residential suites to allow the installation of a personal call system.

For shelter or homeless at-risk projects, tenant-activated emergency call buttons in sleeping rooms, medical rooms, and washrooms can be considered if required by the Owner/Operator.

## .8 Exterior

- .1 Provide lighting to circulation routes, stairs, ramps and outdoor amenity areas to at least 100 lx at ground level.
- .2 Provide lighting with minimal contrast and smooth transition between lit and unlit areas for parking areas, all walkways, entrances, patios and open balconies to maximize the security of tenants.
- .3 Provide motion sensors to activate lighting on secondary walkways and photo sensors for exterior building and primary walkway lighting to reduce electrical power consumption.
- .4 Exterior light fixtures should be energy efficient and low maintenance and should not create shadows, excessive glare, light pollution, upwards aiming light or direct lighting into residents' units. Refer to [Crime Prevention Through Environmental Design](#).

## 9.4 FIRE AND LIFE SAFETY MEASURES

### .1 Suppression and Fire Containment

- .1 Provide sprinkler protection for all projects. Comply with the current BC Building Code, BC Fire Code, NFPA, and Authority Having Jurisdiction.
- .2 Provide listed "residential" sprinklers in all suites, adjoining corridors and common areas, except where prohibited by NFPA or the sprinkler listing. NFPA allows quick response sprinklers; residential types are considered to provide a greater level of safety. Where applicable, use wall mounted sprinklers at top floors to minimize attic space air leakage and freezing of pipes in unheated spaces.
- .3 Firestopping of penetrations in fire separations shall use firestopping and smoke seal systems listed by Underwriter's Laboratory of Canada (ULC) or an approved independent testing agency. Refer to [Construction Standards, Division 07 80 00 - Firestopping and Smoke Seals](#) for detailed requirements.
- .4 For renovation and conversion projects, installation of a sprinkler system can result in impacts to other fire detection and alarm systems. Review of the entire Fire and Life Safety systems must be completed prior to undertaking a sprinkler installation.
- .5 For renovation and conversion projects consideration must be given to Section 5.6 of Division B of the British Columbia Fire Code and Part 8 of the BCBC (Safety Measures at Construction and Demolition Sites). Prior to commencement of construction or demolition, a fire safety plan must be prepared (and maintained for the duration of the construction project) that addresses issues involving fire separations in occupied buildings. If the required fire separation or life safety system cannot be maintained any time during the

project, the contractor must ensure that alternate fire safety provisions are added during that period (i.e. a manual fire watch). Confirm with Owner's insurance.

## .2 Fire Detection and Alarm

- .1 Provide a fire detection and alarm system as required by the BC Building Code and local Authorities Having Jurisdiction.
- .2 It is recommended to have an addressable fire alarm system located in close proximity to the main entrance of the building for ease of emergency personnel response.
- .3 Where a fire alarm system is not required, install smoke alarm(s) with an integral silence switch.
- .4 For projects where there is potential risk of damage to in-suite smoke alarms, staffed on site 24/7, and as confirmed with BC Housing, installation of smoke detectors inside the suites can be considered with approval from the AHJ. Refer to Construction Standards [Division 26 00 00 Electrical](#).

## .3 Fire Safety Plan

The contractor shall prepare a fire safety plan and documentations in accordance with the current BC Fire Code and the Vancouver Fire Bylaw, unless otherwise specified by the Owner/ Operator. Refer to [Division 01 78 00 Closeout Submittals](#).

## 9.5 BUILDING SYSTEMS COMMISSIONING

- .1 All BC Housing funded and financed projects including both new development and renovation/ capital projects shall require commissioning. The level and depth of commissioning required for the project will be determined by the size and complexity of the project itself and by the needs of the Owner's project requirements.
- .2 The consultant team shall be responsible for ensuring that the contract documents are in accordance with the Owner's project requirements, basis of design, meet BC Housing Design Guidelines, building code, by-law requirements and authorities having jurisdiction, and outlining the commissioning requirements and process for all building systems and integration of systems.
- .3 The general contractor is ultimately responsible for ensuring that all building systems and integration of the systems are operating and functioning as intended in the contract documents regardless a third-party commissioning is initiated by the Owner or BC Housing.
- .4 There are four options of implementing the 3rd party independent commissioning process initiated by the Owner/BC Housing. The Owner/BC Housing is responsible to choose one of the four options based upon the local re-zoning by-laws, project classification and size/ complexity of the building.
- .5 The four options are as follows:
  - **Option 1** - Independent Enhanced Commissioning, if required by re-zoning or funding partners (hired by Owner)
  - **Option 2** - Independent Commissioning, 7-storey or higher or high complexity project (hired by Owner)

- **Option 3** - Independent Mechanical Commissioning, 3 - 6 storey or medium complexity project (hired by Owner)
  - **Option 4** - Independent Mechanical Commissioning, 1 - 2 storey or low complexity project (hired by Mechanical Contractor)
- .6** The consultant team shall consider the re-zoning and building commissioning by-law requirements, Owner's 3<sup>rd</sup> - party commissioning options, project size and complexity of the systems and integration of the systems to establish the commissioning activities and systems to be commissioned in the project. Consult with Owner at early development phase.
- .7** Refer to [Section 4, Division 01 91 00 - Building Commissioning](#) and [BC Housing Building Commissioning Guideline](#) for details.

# 10 Landscape Design

## 10.1 LANDSCAPING

### .1 General

- .1** Incorporate the landscape design into the overall sustainability strategy for the project. Use passive landscape design strategies to contribute to the environmental quality of the project.
- .2** Exterior landscape designs should be simple in nature with low maintenance, drought resistant planting and durable hard surfaces as the highest priorities. For sloped areas, review appropriate planting material suitable for that area.
- .3** Provide a reasonable balance of hard and soft landscaped areas. Incorporate interest in landscaped areas by providing a variety of colours, textures, heights and massing.
- .4** The landscaping of interior courtyards and suspended concrete slabs over parkades requires particular consideration in order to avoid ongoing maintenance problems. Built-in planters and large trees with aggressive root systems in these locations are not acceptable.
- .5** To facilitate the maintenance of waterproofed suspended slabs, provide removable landscape finishes such as concrete pavers or movable planters in lieu of large landscape overburden or poured concrete finishes. Review RCABC Guarantee requirements to avoid the need for moisture detection systems in these areas.
- .6** Avoid large heavy planters that could damage concrete pavers and the waterproofing membrane.
- .7** Grass areas should be eliminated or minimized. Avoid grass areas in sloping areas or small areas of sod in locations not readily accessible to a lawn mower, e.g. narrow fingers of sod between parking spaces and small areas on elevated concrete slabs or interior courtyards.
- .8** Locate trees so as not to obscure natural surveillance into an area or block or screen lights.
- .9** Outdoor furniture and seating are to be durable, low maintenance and allow universal access. For senior's projects use benches with backs and arms. Refer to [4.5 Outdoor Spaces](#).

- .10 All landscaping, including movable planters, should be separated from the building by a minimum 6" wide gravel strip and have a minimum clearance of 8" from the underside of the cladding. Window boxes are not acceptable.
- .11 Consider climate adaptation strategies in design. For storm, avoid planting large trees too close to buildings, pathways or roads for vulnerability. Trees are to be placed a minimum 4.5 m (15') away from the building. **Allow natural shading on west and south facing of the building exposures to avoid overheating.**
- .12 Avoid trees that are close proximity to gutters, catch basins and building perimeter to avoid problems from build-up of leaves.

## .2 Landscape Irrigation

- .1 To promote water conservation, provide native or drought resistant landscaping in order to avoid the need for a permanent landscape irrigation system. Providing temporary irrigation from hose bibs on the exterior of the building to help establish initial planting may be considered.
- .2 It is acknowledged that provision of permanent landscape irrigation may be necessary in certain regions of the province or under certain operating conditions. Review of municipal requirements and the Owner's operating requirements should be undertaken at the initial design stages of the project.
- .3 Consider the use of captured or harvested rainwater for site or landscape irrigation. Refer to the section where you talked about water management.

## 10.2 HARD LANDSCAPING

- .1 Provide concrete curbs to all interior roadways. Provide broom finished concrete sidewalks to all interior roadways, building entrances and common areas with exterior access such as the amenity rooms. Consider using permeable paving surfaces to assist with storm water management, installing sustainable drainage systems, and, where paving is necessary, installing permeable (and light coloured) pavements. **Walkways for wheelchair accessible exterior circulation routes within the property shall be at least 1200 mm (4'-0") width, stable, firm and slip resistant, with a slope no more than 1:20 unless designed as a ramp according to Code. On steeper slopes or at grade changes provide a minimum 100 mm (4") curbs or a raised barrier to prevent wheels or walkers from slipping from the walk.**
- .2 Sidewalks should meet accessible requirements defined by Code including maximum grades, slopes and cross slopes, location and sizes of obstacles, guard and handrail requirements and curb cuts. **Sidewalks and grades should slope away from the building.**
- .3 Provide a maximum slope of 5% for exterior walkways. If steeper slope is unavoidable provide handrails to meet Code requirements. Provide minimum slope for surface drainage to prevent slips from ice or water accumulation. Cross slopes for drainage may be provided but must be kept to a maximum of 2%.
- .4 Curb cuts for wheelchair or stroller access should be as gradual as possible and should not project into the roadway. Where a curb cut is in the path of travel, the sides should be sloped to avoid the problem of pedestrians, especially the visually impaired, from unexpectedly stepping down into the cut.

- .5 On the downhill side of sloped sidewalks, provide guards and tapping rails for the safety of persons with mobility or visual impairments.
- .6 Walkways shall be constructed using concrete, unit pavers or other materials which have an even slip-resistant surface. Where precast or unit pavers are used, ensure that joints are flush as possible to a maximum tolerance of 6 mm (1/4") high.
- .7 In order to improve visibility of walkways without additional lighting, use products that create contrast in colour and/or texture. For example, use a different boundary colour and/or texture on the perimeter of walkways.
- .8 Snow Removal**
  - .1 In areas with substantial snowfalls, the site plan must incorporate designated snow storage areas, With adequate drainage to accommodate snow melt and icy conditions during freeze thaw cycles. These areas should be finished with "grass crete", asphalt, or a similar material. Soft landscaping, including sod, should not be used in these areas.
  - .2 Avoid curbs, planters or other snow plough obstructions in parking areas. Provide low profile curb and gutter section.
  - .3 Location and type of fencing should be coordinated with the snow removal plan and CPTED guidelines.
  - .4 Ensure that areas intended for tenant access to the building are protected from ice and snow accumulation or shedding from roof.

### 10.3 BUILDING SIGNAGE

- .1 Provide easy to read building signage. Minimum letter size should be 100 mm (4") or as required by the municipality. Provide a 70% contrasting colour background. Position signs to avoid shadow areas and glare.
- .2 Provide directional signage for sites with more than one building.

### 10.4 EXTERIOR LIGHTING

- .1 Landscape consultant should work closely with electrical consultant to ensure adequate lighting to exterior stairs, ramps and outdoor amenity areas.

### 10.5 FENCING

- .1 If required by the Owner, provide fencing at the perimeter of the site.
- .2 Provide fencing or screening to protect tenants and children from access to potentially dangerous areas such as gas meters, electrical transformers, roads and steep slopes.

### 10.6 RETAINING WALLS

- .1 All abrupt vertical changes in grade greater than 610 mm (2'-0") shall be retained by a modular or poured in place concrete retaining wall engineered to resist the lateral pressure of the retained material.

- .2 Vertical grade changes greater than 610 mm (2'-0") are required to have a 1070 mm (3'-6") high guardrail. Where guardrails are located along walkways, provide graspable handrails installed at a maximum height between 865 mm and 965 mm (2'-10" and 3'-2") from the ground.
- .3 Provide drainage behind all retaining walls.

End of Section

section

# 2

## Energy and Environmental Design

**Technical Bulletin No.1-2020**  
<https://www.bchousing.org/partner-services/asset-management-redevelopment/construction-standards>

- ▶ Sustainability Goals
- ▶ Building and Energy Performance Targets
- ▶ Passive Design Strategies
- ▶ Energy Efficient Products, Incentives and Energy Assessment
- ▶ Construction, Renovation and Demolition Waste Management
- ▶ Water Efficient Design
- ▶ Building Material Selection
- ▶ Sustainable Site Management

# 1 Sustainability Goals

- 1.1** BC Housing is committed to actively support the provincial government's actions leading to creation of a low-carbon economy and sustainable future.
- 1.2** BC Housing's sustainability plan focuses on three strategic areas:
- .1 Development of cutting-edge expertise in demonstrated delivery of sustainable social housing.
  - .2 Gaining recognition within the social housing sector and construction industry as leaders in sustainable social housing.
  - .3 Establishing a best practice approach to integrating sustainability into all levels of decision making.

**1.3** The plan is supported by the following objectives related to buildings:

**.1 Reduce energy consumption levels and GHG emissions**

.1 BC Housing became Carbon Neutral in 2010.

.2 Refer to Technical Bulletin No.1-2020

<https://www.bchousing.org/partner-services/asset-management-redevelopment/construction-standards>

.3

.4 BC Housing has independently adopted a GHG policy for new construction projects that it funds (irrespective of the building ownership) with the goal of reducing GHG emissions to the greatest extent possible while being cost effective. It also requires project managers to include GHG reduction strategies in renovation projects where applicable.

**.2 Achieve BC Housing's Building and Energy Performance Targets**

BC Housing is committed to the following Building Performance Targets for all new construction:

- To
- To
- En
- In
- Pe
- M

When  
Targ  
par  
hav

Refer to Technical Bulletin No.1-2020

<https://www.bchousing.org/partner-services/asset-management-redevelopment/construction-standards>

**.3 Improve indoor environmental quality for tenants**

BC Housing will ensure high quality, healthy living conditions for its occupants by integrating daylighting and outdoor views into rooms, selecting materials that either reduce or eliminate indoor pollutants and providing **optimal** levels of air exchange.

**.4 Enhance resource efficiency**

BC Housing projects will improve resource efficiency by reducing water consumption, waste generation, and potential damage to the natural environment during construction, renovation, operation and demolition of buildings.

**.5 Reduce operating and maintenance costs**

BC Housing projects will preferentially select materials and designs that emphasize durability and ease of maintenance to minimize the long term operating costs for the non-profit owner-operators.

**.6 Maintain a sustainable procurement policy**

The purchase of new products, equipment and appliances shall be limited to green labeled and/or meet a minimum set of criteria for commonly purchased equipment ( i.e. heat pumps, hot water tanks, furnaces, boilers and other type of equipment) approved by BC Housing. These items shall be selected from a pre-qualified list of products provided through either Natural Resources Canada (NRCan), BC Hydro or FortisBC (depending on the product).

## 2 Building and Energy Performance

### 2.1 REQUIREMENTS

.1 The minimum Performance Targets for all new BC Housing projects shall be as follows:

.1 **Part 3 Projects – Combustible (i.e. wood frame) Less than 7 storeys:**

Climate Zone <sup>3</sup>	Step Code Level	FALP	IPALP
<p>Refer to Technical Bulletin No.1-2020  <a href="https://www.bchousing.org/partner-services/asset-management-redevelopment/construction-standards">https://www.bchousing.org/partner-services/asset-management-redevelopment/construction-standards</a></p>			

<sup>3</sup> 3000 to 3999 Heating Degree Days (HDD)

<sup>4</sup> Greater than 3999 Heating Degree Days (HDD)

**.2 Part 3 Projects – Non combustibile (i.e. concrete) 7 storeys and greater:**

Refer to Technical Bulletin No.1-2020  
<https://www.bchousing.org/partner-services/asset-management-redevelopment/construction-standards>

4 Greater than 3999 Heating Degree Days (HDD)

**.3 Part 9 Projects:**

Climate Zone <sup>1</sup>	Step Code Level	Airtightness Testing (ACH@50pa)
4 <sup>2</sup>	<b>Step 4</b>	<b>Refer to Provincial Energy Step Code</b>
5 <sup>3</sup>		
6, 7, 8 <sup>4</sup>		

1 Climate Zone is based on Heating Degree Days (HDD) below 18°C for 25 years period ending in 2006 as per BC Building Code Appendix C - Division B Climatic And Seismic Information for Building Design in Canada.

2 Less than 3000 HDD

3 3000 to 3999 Heating Degree Days (HDD)

4 Greater than 3999 Heating Degree Days (HDD)

**.2 Energy Modelling:** The Energy Targets shall be verified through mandatory building and energy modelling as described in the Provincial Energy Step Code, performed by an experienced Energy Modeller hired by the Owner/Consultant. **Effective building envelope thermal performance** used in the building energy modelling shall be calculated in accordance with the [Building Envelope Thermal Bridging Guide](#). It shall account for heat losses through linear interfaces with major components and point transmittance heat losses, as required by the [City of Vancouver Modelling Guidelines](#). Energy modelling shall be performed in all type of BC Housing projects and results shall be submitted to the Owner and development team at schematic design, building permit and as-built stages. Any changes as the drawings and specifications progress that may impact energy performance shall be included in each stage. As-built energy modelling should include actual airtightness testing result. Refer to [Section 5 Drawing and Document](#).

**.3 Thermal Comfort Evaluation:** A thermal comfort evaluation is required for all passively cooled  
 b Refer to Technical Bulletin No.1-2020  
 b <https://www.bchousing.org/partner-services/asset-management-redevelopment/construction-standards>  
 o

**.4 Whole building airtightness testing:** The actual Envelope Air Leakage Rate shall be confirmed  
 t Refer to Technical Bulletin No.1-2020  
 E <https://www.bchousing.org/partner-services/asset-management-redevelopment/construction-standards> rate  
 d ed.

The airtightness testing result shall be submitted by the contractor at substantial completion. Refer to [Section 4 Division 7 Thermal Bridging and Airtightness](#).

- .5 **Unit airtightness testing:** Interior Partitions Leakage Rate should be tested to ASTM E 779 or equivalent standard, and reported demonstrating its compliance. The sample set shall require testing of at least 10% of total units and be representative of the variety of unit types and locations in the building. Refer to [Appendix B Reducing Air Leakage](#) between Suites.
- .6 Certified Passive House projects are encouraged as they exceed the above targets.

## 3 Passive Design Strategies

### 3.1 INTENT OF PASSIVE DESIGN

“Passive design” is an approach to building design that uses the building architecture to minimize energy consumption and improve thermal comfort. The building form and thermal performance of building elements (including architectural, structural, envelope and mechanical elements) are carefully considered and optimized for interaction with the local micro-climate. It is intended to establish a common vision and support decision making for new developments that will maximize occupant health and comfort and minimize energy use by relying less on mechanical and electrical systems. Furthermore, it is intended to move toward a new, higher standard of energy efficiency without sacrificing thermal comfort.

This section is not prescriptive, but rather discusses and analyzes recommended design approaches and the energy saving opportunities each presents. The design teams should understand the basic concepts and implement the strategies recommended in the following section to optimize passive performance and achieve the many spinoff benefits of energy efficient, thermally comfortable buildings. The application of passive design must be carefully considered within the specific constraints and opportunities of each project.

### 3.2 RECOMMENDED PASSIVE DESIGN STRATEGIES

#### .1 Site and Orientation

The building’s orientation determines the amount of solar radiation it receives and affects energy and comfort implications of solar shading and window-to-wall area ratio. The south facing windows will capture desirable solar gains during winter when the sun angle is low providing desirable passive solar heating during winter. The same solar gains should be reduced through properly designed external shading to reduce requirements for mechanical cooling and to increase comfort of occupants in summer. Windows on the east and west orientations should be carefully planned as they receive the second highest radiation intensities.

#### .2 Building Shape and Geometry

Building shape and geometry have potential to reduce building energy intensity. Buildings with a smaller exterior area, minimal articulation and projections, and a more compact shape will achieve better energy performance. Building geometry must also be considered in relation to daylighting and natural ventilation. Refer to [BC Energy Step Code Design Guide](#).

### .3 Landscape

Properly designed landscape can reduce ambient temperature and limit the heat island effect around the building, protect the building from sun, wind and rain and reduce solar intensity. Planting deciduous trees in front of the building's south and west orientations will provide shading, lower the cooling load in summer, and allow sun to warm a building in winter.

### .4 Space Planning

Planning and locating spaces with specific requirements in their ideal thermal locations in the building can reduce mechanical heating and cooling energy by taking advantage of the building natural thermal responses. Locating spaces with large internal heat gains (such as commercial kitchens and administrative offices) on north or east facing orientations or introducing south facing buffer zones can reduce energy use for mechanical cooling.

### .5 Buffer Spaces

Enclosed balconies are a good example of buffer spaces. Integrating occupied buffer spaces such as corridors and entryways as transition spaces can also be beneficial as they can accept a wider thermal comfort range compared to the fully occupied spaces.

### .6 Solar Shading

Effective shading design requires a balance between admitting desirable solar gains during winter and blocking undesirable solar gains during summer. The optimal shading strategy would be adjustable for different times of the year. Fixed external shading devices can be effectively used for the south and east facing orientations. Excessive solar gains on the west orientations coincide with the hottest part of the day and are difficult to reduce with fixed external shading devices. Use of window coatings, adjustable louvers, trellises, motorized or manually operated external blinds should be considered to help blocking undesired solar radiation on the west orientations. Internal shading helps blocking direct solar glare and radiation from penetrating into the conditioned space; however the solar energy is still transmitted through radiant and convective heat transfer. Proper design of a combination of the external and internal shading devices is an important passive design strategy.

### .7 Windows

Windows are the weakest thermal elements in a building's insulated envelope and have significant impact on indoor thermal comfort and building energy consumption. Transmitting solar radiation through windows is beneficial during winter and undesirable during summer. Carefully selecting window-to-wall ratios for different orientations, choosing adequate shading devices and utilizing good thermal and visual transmittance characteristics are important passive design strategies. Window performance shall be properly modelled in accordance with the Provincial Energy Step Code. For residential buildings the most effective combination should include double or triple-pane window assembly with thermally broken or non-metallic frames and a low-e coating glass **with relatively lower SHGC** for good winter performance in combination with external shading for good summer performance.

### .8 Continuous Thermal Insulation

Effective thermal insulation of the building's opaque elements is one of the most critical design parameters of a building envelope. Thermal insulation impacts the surface temperature on the envelope interior, which directly impacts thermal comfort. Better thermal insulation not only reduces energy use for heating and cooling, but also can significantly reduce the peak heating /

cooling demand and the need for a larger HVAC system. Design of a building envelope should reduce to minimum or completely eliminate thermal bridging through exposed slab edges, roof, balcony overhangs or exposed concrete elements. Effective thermal performance of the building's opaque elements shall be properly modelled in accordance with the Provincial Energy Step Code to capture effect of all thermal bridging. Refer to [Construction Standards Division 07 05 00 Thermal Bridging and Airtightness](#).

#### .9 Air and Moisture Tightness

The air and moisture tightness of a building envelope is a critical factor in its thermal performance and durability. Incorrectly detailed building envelope with undesirable air and moisture diffusion can result in reducing effective thermal insulation, uncontrolled air and moisture exchange between the exterior and interior, potential condensation within the envelope, physical damage of the envelope components from condensation, and occupant health impact associated with mildew and fungus growth. Additional airtightness criteria, specific for the BC Housing projects, also requires all partition walls of a residential suite to prevent transfer of tobacco smoking and cooking odors between the suites and to a corridor. Envelope Air Leakage Rate and Interior Partitions Leakage Rate shall meet the minimum Performance Targets and shall be confirmed by a mandatory testing performed in accordance with the Provincial Energy Step Code and ASTM E 779 respectively. Refer to [Construction Standards Division 07 05 00 Thermal Bridging and Airtightness](#).

#### .10 Passive Cooling

To enhance passive cooling, **optimize window design to maximize ventilation rates. Options could include use of tilt and turn, low and high level operable windows, sill heights to allow larger opening (ensure this meets current building code requirements, safety and accessibility) to increase ventilation rates. Other design approaches that can be adopted including careful positioning of operable windows and doors to promote ventilation, allowing cross-ventilation,** where operable windows are located on adjacent or opposite walls and allow drawing outdoor air across the occupied space. Utilizing passive natural cooling strategies can contribute to reducing energy use for mechanical cooling and improving indoor thermal comfort. Using overnight mechanical ventilation to remove heat accumulated in the building mass during the day and supplying cooler night air can also be an effective passive cooling strategy. Window shading, window coatings and landscape design can also reduce the need for mechanical cooling.

## 4 Energy Efficient Products, Incentives and Energy Assessment

BC Housing is committed to achieving optimal energy performance on equipment and materials that are specified for our existing buildings and in new developments. As such, BC Housing is committed to selecting energy efficient materials and securing all rebates and incentives associated with these energy efficient choices.

- .1 Energy-using equipment shall be selected in consideration of its effect on the Energy Performance Target.
- .2 Energy efficiency measures are meant to reduce the amount of energy consumed while

maintaining or improving the level of comfort in the building. System design and equipment selection should consider the suitability, capital, ease of cost of operation and maintenance, experience and reputation of the equipment manufacturer, local availability, durability, lifespan, energy benefit, environmental health attributes and safety.

- .3 Products shall be green labeled and/or meet a minimum set of criteria for commonly purchased energy-using equipment approved by BC Housing, and selected from a pre-qualified list of products provided through either Natural Resources Canada (NRCan), BC Hydro or Fortis BC.

Refer to Technical Bulletin No.1-2020

<https://www.bchousing.org/partner-services/asset-management-redevelopment/construction-standards>

#### 4.1 ENERGY EFFICIENT SYSTEMS

##### .1 Heating, Ventilation, Air Conditioning (HVAC) Systems:

The heating system will meet the requirement of Section 1 - 8.2 Building and Energy Performance, Mechanical and Electrical Systems and [Section 4- Construction Standards Division 23 00 00 HVAC](#). All furnaces shall be ENERGY STAR® rated high efficiency condensing appliances with minimum 95% Annual Fuel Utilization Efficiency (AFUE). "Right sizing" an HVAC system improves efficiency, reduces noise, offers greater cooling/heating comfort and saves money.

All major ventilation systems shall include heat recovery with a minimum sensible heat recovery effectiveness of 75%.

All boilers shall be high-efficiency appliances with minimum Annual Fuel Utilization Efficiency (AFUE) of:

- 94% and ENERGY STAR® rated for 299 MBH and less;
- 94% and listed on Fortis BC Eligible Commercial Boiler List for condensing boiler with 300 MBH and greater.

#### 4.2 LIGHTING

- .1 Lighting fixtures should be energy efficient and low maintenance; it is strongly recommended to consider LED type light source for all areas. Refer to [Construction Standards Division 26 00 00 Electrical](#).

#### 4.3 APPLIANCES

- .1 Refrigerators, freezers, dishwasher, clothes washers and any other appliances under ENERGY STAR® rating system shall be ENERGY STAR® rated. Cooking appliances and microwaves should be energy efficient, and at the lower end of current EnerGuide rating scale.

#### 4.4 UTILITY INCENTIVE AND REBATE DOCUMENTATION

- .1 The Consultant shall ensure that any applicable rebates and incentives programs available from the local Utility Providers and Public Agencies for implementing energy efficient designs are included and captured in all projects.
- .2 The Contractor will provide all documentation necessary to apply for all applicable incentives, including, but not limited to, appliance invoices, lighting invoices, exhaust fan invoices, boiler invoices, and any related mechanical equipment invoices. Invoices must state the manufacturer, model, unit price, quantity, and physical installation address. For the appliances, lighting, and exhaust fans, a suite or unit breakdown should be provided outlining corresponding

lighting and appliances, including make, model type and confirmation of EnergyStar rating. All documentation must be submitted to the BC Housing staff responsible for managing the project within 30 days of equipment purchase.

#### 4.5 METERING AND REPORTING

- .1 Independent Utility metering shall be provided for each of the following areas:
  - Electricity: separate BC Hydro or Fortis Electric meters for residential areas, common areas, lease spaces and common lease space. Each residential unit shall be provided with a meter base for future individual metering.
  - Gas: separate meters for residential areas, common areas and lease spaces.
  - Refer to [Section 1 General Design Guidelines, Building Systems](#).
- .2 The Operator shall ensure that building is set up to track and report their annual energy use using the ENERGY STAR Portfolio Manager® tool.

#### 4.6 ENERGY ASSESSMENT AND ENERGY CONSERVATION MEASURES (ECM)

- .1 Energy assessment (energy audit) shall be performed for all renovation and conversion projects by minimum ASHRAE level 2 assessment or equivalent for appropriate project scope. The detailed energy assessment report should be completed by a qualified professional and submitted prior to construction stage.
- .2 The energy audit report should provide the list of all potential ECMs applicable to the project with associated implementation cost, savings, **current and post retrofit GHG emissions levels**, lifetime of measures, **discounted** payback periods and net present value (NPV). ECMs should be identified to improve the energy efficiency of building infrastructure, such as lighting, heating/cooling/ventilation systems, utility systems, building envelope systems, windows, etc. Refer to [Section 5 Drawing and Document Requirements](#) for **submittal requirements**.
- .3 **Refer to Technical Bulletin No.1-2020**  
<https://www.bchousing.org/partner-services/asset-management-redevelopment/construction-standards>
- .4 If installing new equipment or appliances, products shall meet the most up-to-date requirement of BC Housing's energy efficient products as mentioned in above articles.

## 5 Construction, Renovation and Demolition Waste Management

BC Housing is committed to reducing resource consumption and waste, as mandated in the [livegreen BC Housing's Sustainability Plan](#). Waste reduction and diversion from landfills will be targeted for all construction, renovation and demolition (C&D) projects funded **or financed** by BC Housing across the Province.

### 5.1 REQUIREMENTS

- .1 Projects must achieve a C&D waste diversion target of 80% of the total waste generated in the Lower Mainland and on Vancouver Island, and 60% for projects elsewhere in the Province. The

total waste generated excludes any hazardous or excavated materials. All materials banned and prohibited from landfill according to the regional regulations shall be recycled.

- .2 C&D waste reduction and diversion from landfills is required across the Province for all projects that receive the majority of funding from BC Housing including:
  - .1 all new construction projects;
  - .2 all demolition projects regardless of **project** budget; and
  - .3 all renovation and capital improvement projects **budgeted** over \$100,000 (public tender).
- .3 The development team shall incorporate the Waste Management requirements into the contract documents and project specifications.
- .4 The Contractor shall submit the Waste Management Plan prior to demolition and construction stage. Refer to [Division 01 74 19 Construction Waste Management and Disposal](#) for requirements and implementation.
- .5 The Contractor is responsible for tracking waste diversion rates throughout the construction project, and shall submit the Waste Management Reporting Form, outlined in [Division 01 74 19 Construction Waste Management and Disposal](#). The completed form is required to submit at the following stages:
  - .1 completion of demolition (if applicable);
  - .2 50% construction progress claim; and
  - .3 substantial completion.

A deficiency holdback will be retained for incomplete or non-submitted waste tracking forms as set out in the contract documents.

## 6 Water Efficient Design

Water conservation strategies should be employed to reduce water consumption at a facility through efficient water system design, water efficient plumbing fixtures and appliances, water metering, etc.

### 6.1 WATER EFFICIENT FIXTURES AND APPLIANCES

- .1 Low water consumption fixtures shall be provided for all units:
  - .1 Aerated bathroom faucet with flow rate of 2 LPM (0.5 GPM);
  - .2 Low flow showerhead with flow rate of 5.7 LPM (1.5 GPM);
  - .3 Low **flush water closets**: single flush 4.8 LPF (1.3 GPF), and complies with the latest edition Maximum Performance (MaP) testing rated at 1000 gram of waste per flush;
  - .4 Kitchen sink faucet: 5.7 LPM (1.5 GPM) flow pressure compensating aerator outlet;
  - .5 Refer to [Construction Standards, Division 22 00 00 Plumbing](#), for details on plumbing fixtures and accessories.

- .2 Water efficient appliances with ENERGY STAR® certification shall be provided, including clothes washer and dishwasher, where required.

## 6.2 WATER METERING

- .1 A total building water meter shall be provided. Where applicable, provide separate water sub-meters to areas with separate lease agreements. Confirm requirements for water sub-metering with BC Housing and Operator.

# 7 Building Material Selection

## 7.1 LOW EMITTING MATERIALS REQUIREMENT

- .1 Select low emitting materials and products for interior paints, coatings, adhesives, sealants, flooring, composite wood, ceilings, walls, and thermal and acoustic insulation.
  - .1 Paints and coatings must meet Canadian Volatile Organic Compound (VOC) Concentration Limits for Architectural Coatings Regulations (SOR/2009-264).
  - .2 Adhesives, and sealants must meet SCAQMD Rule 1168, effective July 1, 2005.
  - .3 Paints, coatings, adhesives and sealants must not contain methylene chloride and perchloroethylene.
  - .4 Stone, ceramic, powder-coated metals, plated or anodized metal, glass, concrete, clay brick and unfinished or untreated solid wood flooring must not include integral organic-based surface coatings, binders or sealants.
  - .5 Composite Wood to comply with California Air Resources Board (CARB) ultra-low-emitting formaldehyde (ULEF) resins or no added formaldehyde resins. Composite wood cannot exceed 0.05 ppm of formaldehyde as tested under EN-717-1:2004, ISO 16000-3:2010, ISO 16000-6: 2011, ISO 16000-9:2006, ISO 16000-11:2006 or CEN/TS 16516: 2013.

## 7.2 RECYCLED PRODUCT AND LOCAL AVAILABILITY

- .1 Consider using materials that are sourced locally and have high recycled content. Utilize existing materials on site when possible. The selection of interior and exterior materials is a vital part of a project's sustainability.

# 8 Sustainable Site Management

## 8.1 CONSTRUCTION ACTIVITY POLLUTION PREVENTION

- .1 Pollution, erosion and sedimentation control plan for all construction activities associated with the project should be created and implemented. The plan must conform with the erosion and sedimentation requirements of the 2012 US Environmental Protection Agency (EPA) Construction General Permit (CGP) or local equivalent, whichever is more stringent.
- .2 In sensitive environmental areas (adjacent to waterways, wetlands, flood plains, etc.) an

environmental consultant should be engaged.

## 8.2 SUSTAINABLE SITE WATER MANAGEMENT AND LANDSCAPE

- .1 Incorporating passive landscape design strategies into the project sustainability strategy should be considered, to contribute to the environmental quality of the project and to minimize heat island effect around the building.
  - .1 To address erosion control and storm water management, a comprehensive site water management strategy should be developed by the project team, such as implementing pervious paving, rain gardens, and bio swales.
  - .2 To promote water conservation, provide native or drought resistant landscaping in order to avoid the need for a permanent landscape irrigation system. Providing temporary irrigation from hose bibs on the exterior of the building to help establish initial planting may be considered.
  - .3 To minimize the heat island effect around the building, and reduce solar intensity, locate deciduous trees in front of the building's south and west orientations to provide shading, lower the cooling load in summer, and to allow the sun to warm the building in winter.

## 8.3 RECYCLING AND COMPOSTING AREA

- .1 All sites shall be equipped with a collection and storage area for garbage, recyclable materials and organics, in accordance with municipality requirement. Refer to [Section 1 - General Design Guidelines](#) for further details.

End of Section

section

# 3

## Crime Prevention Through Environmental Design (CPTED)

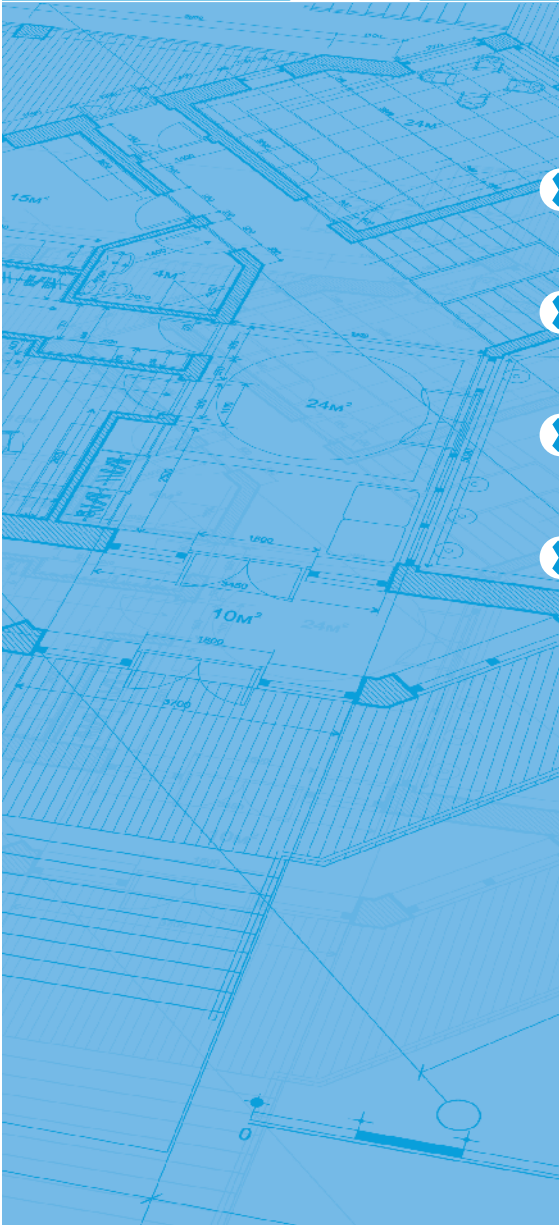
- 
- Description
  - CPTED Principles
  - CPTED Performance Objectives
  - CPTED Performance Standard Checklist

# 1 Description

Crime Prevention Through Environmental Design (CPTED) is defined as a multi-disciplinary approach to deterring criminal behaviour and nuisance activity through environmental design. CPTED strategies rely upon the ability to influence decisions that precede criminal acts and nuisance activity through proper design, effective use and maintenance of the built, social and administrative environment. Realizing that there is a direct relationship between the physical environment, behaviour of people, productive use of space and crime/loss prevention, BC Housing has the following CPTED principles:

- .1 Territoriality
- .2 Natural Surveillance
- .3 Access Control
- .4 Activity Support
- .5 Maintenance

CPTED based strategies emphasize enhancing the perceived risk of detection and apprehension. Research into criminal behaviour indicates that the decision to offend or not to offend is more influenced by cues to the perceived risk of being caught than by cues to reward or ease of entry. Behaviour effects can be accomplished by reducing the propensity of the physical environment to support criminal behaviours.

## 2 CPTED Principles

Crime Prevention through Environmental Design (CPTED) is supported by the following five overlapping principles that are applied to specific sites and situations.

### 2.1 TERRITORIALITY

Territoriality is a design concept that clearly delineates private space from semi-public and public spaces and also creates a sense of ownership. Ownership thereby creates an environment where appearances of such strangers and intruders stand out and are more easily identified through:

- .1 The enhanced feeling of legitimate ownership by reinforcing existing natural surveillance and natural access control strategies with additional symbolic or social ones
- .2 The design of space to allow for its continued use and intended purpose
- .3 The use of pavement treatments, signage, landscaping, art, signage, screening and fences to define and outline ownership of space

### 2.2 NATURAL SURVEILLANCE

Natural surveillance is a design concept directed primarily at observing intruders. Provision of natural surveillance helps to create environments where there is sufficient opportunity for people engaged in their normal activities to observe the space around them. Areas can be designed so they are more easily observed through:

- .1 Design and placement of physical features to maximize visibility. This may include: building orientation, windows, entrances and exits, parking lots, refuse and recycling containers, walkways, guard gates, landscaping, trees and shrubs, use of wrought iron fences or walls, signage and other physical obstructions
- .2 Placement of persons or activities to maximize surveillance possibilities
- .3 Provision of minimum maintained lighting standards for nighttime illumination of parking lots, walkways, entrances, exits, and related areas to promote a safe environment

### 2.3 ACCESS CONTROL

Access control is a design concept directed primarily at decreasing criminal accessibility. Provision of natural access control limits the number of entry points to the property and building. Intruders are discouraged or denied entry through:

- .1 The use of sidewalks, pavement, gates, lighting, way-finding signage, and landscaping to clearly guide the public to and from entrances and exits
- .2 The use of gates, fences, walls, landscaping and lighting to prevent or discourage public access to or from dark or unmonitored areas
- .3 The use of locks, electronic access control systems, guards or reception staff, non-removable pin hinges and other target hardening measures

## 2.4 ACTIVITY SUPPORT

Activity support is the presence of activity planned for the space, and involves placing activity where the individuals engaged in an activity will become part of the natural surveillance system.

- .1** Place safe activities in areas that will discourage would-be offenders, to increase the natural surveillance of these activities and the perception of safety for normal users, and the perception of risk for offenders. Examples include a seating area facing out the window from the inside of the lobby.
- .2** Place high-risk activities in safer locations to overcome the vulnerability of these activities by using natural surveillance and access control of the safe area. Examples include a playground located inside the fenced/enclosed courtyard of a building, or a recreation room with many windows along the main lobby of the building.
- .3** Locate gathering areas to provide for natural surveillance and access control or in locations away from the view of would-be offenders.

## 2.5 MAINTENANCE

A well-maintained property contributes to territoriality by projecting ownership. Sites in disrepair provide a rationalization for activity by criminals. Also, if signs, gates and lights are not working, they will not add value to the site.

- .1** Provide a standard of maintenance document that describes the proper maintenance of the site, the fixtures, and the buildings.
- .2** Locating lighting in such a way that bulbs can be easily replaced and shrubs and vegetation do not obstruct light from intended target areas
- .3** Landscaping which is maintained at prescribed standards so that the placement and growth of shrubs and vegetation does not interfere with sight lines or light sources

# 3 CPTED Performance Objectives

## 3.1 ACCESS CONTROL

- .1 The security of the property is enhanced by discouraging casual intrusion by non-residents, and public access should be restricted. Access control systems should be designed around a combination of systems which may include a concierge, digital access control (DAC) and door intercom system.
- .2 There should be no paths which could be used to gain unobserved access.
- .3 Easily found address and directional signage should be provided to deter unauthorized access and to assist emergency services, trades persons, etc.

## 3.2 BALCONIES

Enclosures to balconies at all levels should be designed to exclude handholds and to eliminate the opportunity for climbing up, down or across between balconies.

## 3.3 CAR PARKING

- .1 Individual car parking arrangements are preferred but where communal car parking areas are necessary, they should be in small groups, close and adjacent to the suites which they serve, and open to view of the residents from frequently occupied rooms.
- .2 Garages should be located to maximize opportunities for natural surveillance.
- .3 Underground parking should include well lit walls, posts, ceilings, and way-finding signage which can be achieved through lighting, paint, white concrete stain, window placement, or a combination thereof. Entrances to garages should be designed to be within the boundaries of the secured area. In certain conditions additional security features such as cameras may be required for parking.
- .4 Pavement treatment and maintenance in parking areas, such as painted curbs, parking symbols and lines, help to define the transition from public to semi-private space and create a sense of ownership and territoriality.

## 3.4 COMMUNAL FACILITIES

Communal facilities on the ground floor, such as residents' communal lounges and common laundry rooms are best located to give natural surveillance of entrances, entrance lobbies and external areas. Bin storage and chutes, service ducts and panels, pipes and door entrance canopies should be designed to eliminate the opportunity for unauthorized access and climbing. Secure bicycle storage for residents and visitors should be considered.

## 3.5 CONCIERGE/BUILDING MANAGER OFFICES

Where a concierge service is provided, entrances and fire exits should be audibly alarmed to the concierge control centre. Where provided, building managers offices should be located adjacent to main entrances, and directly accessible to the concierge control centre, if applicable. Building manager offices should include two room areas, one within view of the outside area adjacent to the office and one that is not within view.

### 3.6 CRIME GENERATORS

A crime generator is a location whose most likely frequented participants create a higher than average probability of illegal or inappropriate activity. Consideration should be given to locating potential crime generators within areas that have been secured from public access and where they are not likely to allow the escalation of problematic activities.

### 3.7 DIGITAL ACCESS CONTROL (DAC) AND CLOSED CIRCUIT TELEVISION (CCTV)

Main entrances to multi-tenanted buildings should be fitted with a digital access control system. This may be DAC entry system, a door entry phone system and electrical lock release or a combination of these. Where a DAC entrance system, concierge and CCTV system are provided, consideration should be given to extending these systems to cover the internal circulation areas, for example DAC entry/door entry systems may be provided on landings and accessing elevator floors.

### 3.8 DISPLACEMENT ISSUES

CPTED solutions should be designed to eliminate the problem versus relocating or displacing problems to other areas of the neighborhood or property.

### 3.9 EDGE EFFECTS

Buildings and structures should be constructed in a fashion that avoids the actual or perceived “unused” areas that become partially or fully hidden from view. Windows or spandrel glass (appearing like real windows) should be installed in areas where an end wall may have little or no natural surveillance over a space where socialization may occur. The property layout should provide each block with a clearly defined defensible space, and fencing where appropriate.

### 3.10 ENTRAPMENT SPOTS AND MOVEMENT PREDICTORS

Entrapment spots and movement predictors should be eliminated where possible. When options to eliminate entrapment areas or movement predictors do not exist, they should be located in areas of high visibility, including formal surveillance, and/or should include means of emergency communication.

### 3.11 EXTERIOR ENTRANCES

The entrances to a building should be preceded by elements such as fences, shrubs, and/or pathway treatments that identify a transition from public to semi-private space. Often they form the first physical barrier to access for outsiders. Where possible, a single point of entry should be provided, and all other access points required for fire egress safety should be restricted to exit only. Resident access should be limited to no more than two locations where possible. Doors should all be well lit, easily visible and not recessed behind site-line obstructions.

### 3.12 FORMAL SURVEILLANCE

A monitored (active and passive) close circuit television (CCTV) system covering the site area, with particular focus on key access points may be required. Consideration should be given to providing residents with the ability to view CCTV images from entrances and other areas that

may be considered of risk. All systems must be designed to adhere to the standards of the Privacy Commissioner of BC.

### **3.13 GARAGES**

All doors leading to parking garages should be secured, and minimizing the number of entry doors is recommended. Windows should be provided in garage doors. On carports and single car garages, roofs should be pitched (flat roofs should be avoided), and rainwater leaders etc, should be located so as to avoid providing climbing opportunities.

### **3.14 INTERNAL SECURITY**

Communal internal circulation areas, staircases, entrances and elevator lobbies should be brightly decorated and well lit, and a hierarchy of defendable space established. Access staircases should be linked to the minimum number of dwellings. External walkways should be eliminated wherever possible, or the number of dwellings accessed from them limited to the minimum compatible with the physical form of the building and the need for fire safety.

### **3.15 LANDSCAPING**

- .1** Landscaping is an important feature of CPTED. Landscaping should not impede natural surveillance and must not create blind spots or potential hiding places for intruders, especially adjacent to footpaths or close to buildings where it may obscure doors and windows.
- .2** Ornamental walls and hedges should not exceed one metre in height. Grass or low ground cover planting only should be used within 2 metres of either side of a footpath. The location and species of trees should not allow them to obscure lighting or CCTV, or become climbing aids. Take into account the maintenance needs to ensure continued compliance as plants grow. The correct use of certain species of plants can help prevent graffiti and loitering, and in addition to fencing may be used to define/reinforce boundaries. Landscaping such as berberis, low-height fencing, bio-swales, or similar products should be utilized to achieve this purpose. Private and semi-private yard spaces should have clearly defined boundaries.

### **3.16 LIGHTING, ILLUMINATION AND COLOUR/IMAGE RENDERING**

- .1** Appropriate lighting should be carefully designed to cover potential high risk areas.
- .2** Uniform and consistent levels of lighting should support all areas of natural and CCTV surveillance in order to deter intruders and reduce the fear of crime. Light sources should provide for accurate colour rendering, and light levels should place greater emphasis on the consistency of light versus the brightness level. The following areas must be lit: main site access, garages, car parking areas, all footpaths and associated doorways and accesses to the main building, refuse storage, secluded areas and similar locations around the site that are intended for use at night.
- .3** All exterior lighting for:
  - .1** Primary areas (building exterior, primary entrances, primary walkways, etc) should be automatically controlled by photo-electric cell activator.
  - .2** Secondary areas (alternate egress routes, landscaped walkways, areas of risk, etc) should be

automatically controlled by motion sensor. Light fixtures, fittings and service wiring should be vandal resistant and located to minimize vulnerability to vandalism.

### **3.17 LINE OF SIGHT**

All public and semi-private areas should maintain an unobstructed view from areas that are frequently and regularly occupied.

### **3.18 MOVEMENT PREDICTORS**

Any design feature that funnels or channels people along a route that contains few or no exits prior to the destination is a movement predictor. These should be avoided. (See entrapment spots)

### **3.19 NATURAL SURVEILLANCE**

Optimum natural surveillance should be incorporated, whereby residents can see and be seen. Recesses, blind corners and hiding places should be eliminated wherever possible. The use of mirrors can assist in this measure. Additional measures should include:

- .1** An unobstructed view from dwellings of the site, its external spaces and neighbouring homes to include external paths, roadways, common areas, yards, landscaping, garages, entrance/exit doors and parking areas
- .2** The avoidance /elimination of recesses, blind corners, and hiding places
- .3** Windows placed in doors to stairways, laundry rooms, common hallways, recreation rooms, and other areas requiring visibility to improve safety

### **3.20 PATHWAY/WALKWAY PRINCIPLES**

- .1** Superfluous and unduly secluded access points and routes should be avoided. Access points to the rear of buildings should be controlled, for example by means of lockable gates. Roads to groups of buildings should be designed to create a sense of identity, privacy and shared ownership amongst occupants. Foot and bicycle paths should be of generous width and have a suitable landscape setting to avoid creating narrow corridors which could be perceived as threatening. In terms of security, the design of the footpath is of equal importance to the design of the building. Where possible, the footpath route should be at least 3-4 metres wide, which includes a verge on either side of the 2 metre wide walkway.
- .2** Any shrub/planting should start at the back of the verges. The position of planting and choice of species should be such that hiding places are not created. Thorny species of shrub can help to deter intruders. Good visibility should be maintained from either end, and along the route of foot and bicycle paths. Sharp changes in direction should be avoided.
- .3** Foot and bicycle paths should not generally be routed to the rear of buildings, but if this is unavoidable a substantial buffer should be planted between a secure boundary fence and the footpath's margins, with planting designed so as to discourage intruders.
- .4** Where developments adjoin waterways, rivers with foot/bicycle path access, parks or similar public spaces, the buildings should 'face both ways', i.e. overlook the watercourse as well as the street. Foot/bicycle paths should be lit in built-up areas, except where the route is passing

through woodland or an ecologically sensitive area, in which case an alternative lit route should be made available, such as a footway alongside a road.

### **3.21 PAVEMENT TREATMENTS**

Pavement treatments can provide a means of territoriality and help to define/demarcate transitions between public, semi-private and private space. Changes in pavement treatments, such as moving from concrete to stone walkways, help to define boundaries.

### **3.22 PHYSICAL SECURITY AND FIRE/EGRESS REGULATIONS**

In multi-tenant buildings, particular care needs to be taken to ensure that the security measures do not conflict with fire regulations with respect to means of escape in case of fire. In all cases, locks must be able to be opened from the inside without the aid of a key, to comply with fire regulations.

### **3.23 SIGNAGE AND WAY FINDING**

Address and way finding signage should be located at intersecting pathways, in parkades, and along driveways where the destination building signage cannot easily be seen. Address signage should be large enough to be clearly legible from the street and must have a source of light for viewing in darkness. Signage should be located where it can easily be seen for way finding, but should not be placed where it would interfere with the line of sight for vehicles or pedestrians, or where it would be easily vandalized. Exterior signage located at ground level or where it could be easily vandalized can be protected by planting berberis or similar products in a 1 metre or larger circumference around the base. Intercom displays should not include both the suite number and name of occupants, rather, the name and an entry code number, unrelated to the suite number, should be used.

### **3.24 STREET LIGHTING**

Consideration should be given to ensure that lighting meets with these same standards on the building walkways along the street.

### **3.25 STREET PRESENCE**

This is the perception of the property that is created at the boundary of the property where it borders the municipal street in terms of the CPTED principles.

### **3.26 TARGET HARDENING**

Entrance and exit doors, including their frames, hinges and locks should be of robust, vandal-resistant material. Vandal resistant viewing panels should be fitted into doors. Entrances should be well lit internally and externally. External opening swing doors should be fitted with non-removal hinge pins, full length astragals and vandal-resistant locking devices. Doors, frames, equipment and finishes in circulation areas, including elevators, should be designed to be vandal resistant. Lock boxes should be securely flush mounted rather than a protruding surface mount.

### **3.27 TERRITORIALITY**

This relates directly to the concept of ownership and the building design should lend itself to

allowing the building owner and its occupants to portray/express a sense of ownership by defining the transitions from public to semi-private and then private space.

### **3.28 TRAFFIC CALMING**

These devices and measures are used to control the volume and/or speed of traffic at the posted/required area. Examples can include speed bumps, traffic circles/roundabouts, bollards, and narrow lanes.

### **3.29 VULNERABILITIES**

Identification of one or more weaknesses in the design and/or operation of the property as it relates to the prevention of crime or nuisance behaviours.

### **3.30 WINDOWS**

- .1** Ground floor windows and those easily accessible above the ground floor must have a multipoint locking system to lock the window from being opened from the outside. Windows should be located on all sides of the building to provide full visibility of the property.
- .2** Where necessary, opening restrictors or similar built-in mechanisms should be utilized. Where windows are required under the building code to act as an egress, the opening window must not have key operated lock. These egress windows must not be restricted in any way to prevent emergency exit from building. Instead of bars, consider all other alternatives such as laminated glass.

## 4 CPTED Performance Standard Checklist

CPTED PERFORMANCE STANDARD CHECKLIST			
Principle/ Objectives	Design Intent	Evaluation Standard	Comments
<b>Building Identification</b>	<i>Ensure buildings are clearly identified by street number to prevent unintended access and to assist persons trying to find the building.</i>	Street numbers should be plainly visible and legible from the street or road fronting the property.	
		In residential uses, each individual unit should be clearly numbered. In multiple building complexes, each building entry should clearly state the unit numbers accessed from that entry. In addition, directional signage to unit numbers should be provided on each level or floor.	
		Street numbers should be made of durable materials, preferably reflective or luminous, and unobstructed (e.g. by foliage).	
		For larger projects, provide location maps (fixed plaque format) and directional signage at public entry points and along internal public routes of travel.	
<b>Common/ Open Space Areas and Public On-Site Open Space</b>	<i>Provide natural surveillance for common/open space areas</i>	Position active occupancies or occupied rooms with windows adjacent to main common/open space areas, e.g. playgrounds, swimming pools, etc., and public on-site open space.	
		Design and locate dumpster enclosures in a manner which screens refuse containers, minimizes opportunities to hide, and provides direct vehicle access for the removal and replacement of the bin.	
		Locate waiting areas and external entries to elevators/stairwells close to areas of active occupancies to make them visible from the building entry.	
		Foot and bicycle paths should be of generous width and have a suitable landscape setting to avoid creating narrow corridors which could be perceived as threatening.	
		Locate seating in areas of active uses.	
<b>Exterior Entrances</b>	<i>Provide entries that are clearly visible</i>	Design entrances to allow users to see into them before entering.	
		Entrances should be clearly identified.	
	<i>Avoid confusion in locating building entrances</i>	Entrances should be easily recognizable through design features and directional signage.	
		Minimize the number of entry points.	
<b>Fencing</b>	<i>Fence design should maximize natural surveillance from the street to the building and from the building to the street, and minimize opportunities for intruders to hide</i>	Front fences should be predominantly open in design, e.g. pickets or wrought iron, or solid fencing no higher than 1.2 meters.	
		Design other high solid fences in a manner that incorporates open elements such as lattice to allow visibility above the height of 1.5 meters.	
		If noise insulation is required, install other devices at the front of the building rather than solid fences higher than 1.5 meters.	
		Other landscape features such as elevation changes or berberis landscaping should be used in conjunction with fences in locations where climbing the fence is likely.	

**CPTED PERFORMANCE STANDARD CHECKLIST**

Principle/ Objectives	Design Intent	Evaluation Standard	Comments
<b>Landscaping</b>	<i>Avoid landscaping which obstructs natural surveillance and allows intruders to hide</i>	Trees with dense low growth foliage should be spaced or their crown should be raised to avoid a continuous barrier.	
		Use low groundcover, shrubs a maximum of .6 meters in height, or high-canopied trees (clean trimmed to a height of 2.4 meters) around children's play areas, parking areas, and along pedestrian pathways.	
		Avoid vegetation that conceals the building entrance from the street.	
	<i>Use vegetation as barriers to deter unauthorized access</i>	Consider using berberis plants as an effective barrier in place of or in addition to fencing, and to obstruct access to walls, fences and other structures prone to graffiti.	
	<i>Avoid placement of vegetation or structures that would enable access to a building or to adjacent buildings</i>	Avoid placement of large trees, garages, utility structures, fences, and gutters next to second story windows or balconies that could provide a means of access.	
<b>Lighting – Exterior</b>	<i>Provide exterior lighting that enhances natural surveillance</i>	Prepare a lighting plan in accordance with BC Housing Standards, which addresses project lighting in a comprehensive manner. Select a lighting approach that is consistent with local conditions and eliminates crime.	
		Locate elevated light fixtures (poles, light standards, etc.) in a coordinated manner that provides the desired coverage. The useful ground coverage of an elevated light fixture is roughly twice its height.	
		For areas intended to be used at night, ensure that lighting provides visibility. Where lighting is placed at a lower height, ensure that it is vandal resistant.	
		Ensure inset or modulated spaces on a building facade, access/egress routes, and signage is well lit.	
		In areas used by pedestrians, ensure that light shines on pedestrian pathways and possible entrapment spaces.	
		Place lighting to take into account vegetation, in its current and mature form, as well as any other element that may have the potential for blocking light.	
		Avoid lighting of areas not intended for nighttime use to avoid giving a false impression of use or safety, or alternatively, use motion activated spot lights in these areas.	
		Provide uniform areas of light versus over-lighting areas which creates significant contrast to areas of darkness.	
		Select and light "safe routes" so that these become the focus of legitimate pedestrian activity after dark.	
		Avoid climbing opportunities by locating light standards and electrical equipment away from walls or low buildings.	
		Use photoelectric rather than time switches for exterior lighting.	
Placement of lighting and cameras needs to be coordinated in order that areas to be covered by camera are sufficiently lit and that lighting is not blinding the camera shot.			

CPTED PERFORMANCE STANDARD CHECKLIST			
Principle/Objectives	Design Intent	Evaluation Standard	Comments
<b>Mix of Uses</b>	<i>In mixed use buildings, increase opportunities for natural surveillance while protecting privacy</i>	Where allowed by code, locate shops and businesses on lower floors and residences on upper floors. In this way, residents can observe the businesses after hours while the residences can be observed by the businesses during business hours.	
		Include food kiosks, restaurants, etc. within parks and parking structures.	
		Access to dwellings or other uses above commercial/retail developments should not be located in secluded areas.	
<b>Natural Surveillance</b>	<i>Avoid blind corners in pathways and parking lots.</i>	All public and semi-private areas should maintain an unobstructed view from areas that are frequently and regularly occupied. Pathways should be direct.	
		Consider the installation of mirrors to allow users to see ahead of them and around corners.	
		Any barriers along pathways should be transparent (see through) including landscaping, fencing etc.	
	<i>Ensure occupants can see and be seen</i>	Windows should be placed in doors or adjacent walls to stairways, laundry rooms, common hallways, recreation rooms, and other areas requiring visibility to improve safety.	
<b>Ownership and Maintenance</b>	<i>Create a "cared for" image</i>	Ensure that landscaping is well maintained to give an impression of ownership, care, and security.	
		The building design should allow the building owner and its occupants to portray/express a sense of ownership by defining the transitions from public to semi-private and then to private space.	
		Use materials which reduce the opportunity for vandalism.	
		Consider using strong, wear resistant laminate, impervious glazed ceramics, treated masonry products, stainless steel materials, anti-graffiti paints, and clear over sprays to reduce opportunities for vandalism. Avoid flat or porous finishes in areas where graffiti is likely.	
		Where large walls are unavoidable, utilize vegetative screens to prevent vandalism and graffiti.	
		Where exits are closed after hours, ensure this information is indicated at the parking area entrance.	
<b>Security</b>	<i>Reduce opportunities for unauthorized access</i>	Utilize security hardware and/or human measures at each entry point to reduce opportunities for unauthorized access.	
<b>Security Bars, Shutters, and Doors</b>	<i>When used and permitted by building and fire codes, security bars, shutters, and doors should allow observation of the street and be consistent with the architectural style of the building</i>	Security doors should include laminated glass panels to enhance visibility.	
		Security bars should be avoided in favour of alternatives such as security film, laminates, wired glass, alarmed spaces, and barriers to the glassed area such as landscaping, fences, bollards and planters.	

CPTED PERFORMANCE STANDARD CHECKLIST			
Principle/Objectives	Design Intent	Evaluation Standard	Comments
<b>Signage</b>	<i>Ensure that signage is clearly visible, easy to read and simple to understand</i>	Use strong colours, standard symbols, and simple graphics for informational signs.	
		Address and way finding signage should be located at intersecting pathways, in parkades, and along driveways where the destination building signage cannot easily be seen.	
		Upon entering the parking area, provide both pedestrians and drivers with a clear understanding of the direction to stairs, elevators, and exits.	
		In multi-level parking areas, use creative signage/colours to distinguish between floors to enable users to easily locate their cars.	
		Signage should advise users the security measures that are in place, and identify locations such as security phone, panic alarm or intercom system.	
		Where exits are closed after hours, ensure this information is indicated at the parking area entrance.	
<b>Site and Building Layout</b>	<i>Allow natural observation from the street to the occupancy, from the occupancy to the street, and between occupancies</i>	Orient the main entrance towards the street, or on corners, to both streets.	
		Position occupied rooms with windows at the front of the dwelling.	
		Offset windows, doorways and balconies to allow for natural observation while protecting privacy.	
		Minimize the number of entry points, and locate the main entrances/exits at the front of the property and in view of the street.	
		If employee entrances must be separated from the main entrance, they should maximize opportunities for natural surveillance from the street.	
		Avoid large expanses of parking. Where large expanses of parking are proposed, provide surveillance such as security cameras.	
		In parkades, access to elevators, stairwells and pedestrian pathways should be clearly visible.	
		Avoid hidden recesses.	
		Locate parking areas where they can be observed by adjoining occupancies.	
		Open spaces such as parks, plazas, common areas, and playgrounds must be clearly designated and situated at locations that are easily observable by people.	
	<i>Develop a sense of ownership for occupants</i>	Where possible, design multi-unit residential occupancies such that no more than six to eight units share a common building entrance.	
		Common area and/or street furniture shall be made of durable, vandal resistant materials and secured by sturdy anchor points.	
		Communal facilities on the ground floor, such as residents' communal lounges and common laundry rooms, should be located to provide natural surveillance of entrances, entrance lobbies and external areas.	

End of Section

section

# 4

## Construction Standards

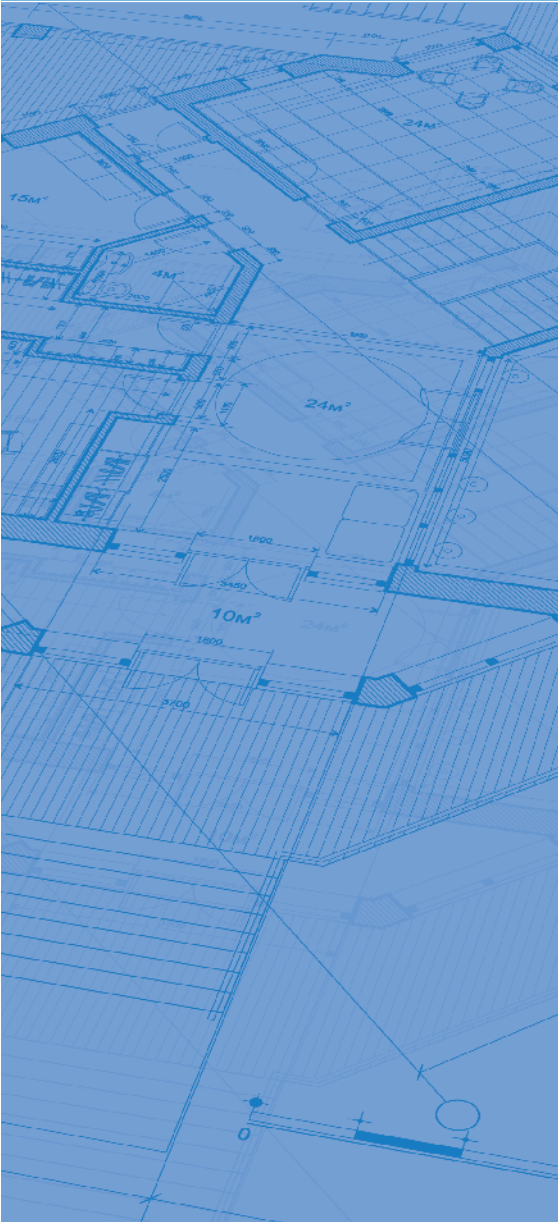

# Introduction to Construction Standards

## 1 Purpose

The purpose of the Construction Standards is to establish performance requirements for construction materials and assemblies that optimizes occupant satisfaction and minimizes overall lifecycle costs for the building. Overall lifecycle ownership cost is defined as the sum of:

- .1 Fixed financial criteria: nominal discount rate, length of study
- .2 Investment cost: initial capital cost
- .3 Annual costs: taxes, insurance, maintenance, operation, energy and municipal costs
- .4 User costs: change as a result of staffing requirements
- .5 Periodic costs: replacement, repair, alteration and re-decoration
- .6 Salvage value: at the end of material or equipment's useful life

Compliance with these standards is mandatory unless specifically waived by BC Housing in consultation with the **design team**.

## 2 Scope

These Construction Standards apply to housing developments whose capital and/or operating budgets are funded or financed by BC Housing regardless of project type, including new construction, conversions, and renovations. The design consultant, in consultation with BC Housing, must apply these construction standards to the design and specifications of the project as applicable.

## 3 Construction Standards and Specifications

The Construction Standards are intended to be the reference for the full project-specific specifications prepared by the design consultant. The design consultant is not to reproduce these standards for project specifications, but to refer to them for information. A qualified construction specification writer should be engaged to prepare the project specifications.

The design consultant is responsible for reviewing the **Owner's project requirements, basis of design, BC Housing Design Guidelines and Construction Standards**, all applicable design and regulatory requirements, and incorporating **those** into the project specifications.

All other clauses identify General, Product, and Execution requirements to be incorporated in the project specifications.

## 4 Alternatives

The design consultant has the option of using any of the listed materials or specifying alternative materials in the standards that meet or exceed the specified requirements **as outlined in these guidelines**. BC Housing/the Owner must be notified, and approve of alternatives, prior to commencement of construction, refer to [Division 01 23 00 - Alternatives](#).

## 5 Hazardous Materials

Also included in this document is a section on hazardous materials which provides information to ensure safe working conditions and compliance with WorkSafeBC. Reference [Appendix A](#) for this information.

## 6 Organization

These Construction Standards are organized according to the 2016 edition of MasterFormat, published jointly by Construction Specifications Canada and the Construction Specifications Institute. MasterFormat is a master list of numbers and titles for organizing information about construction requirements, products, and activities widely accepted as standard practice in Canada. BC Housing requires that project specifications follow MasterFormat numbering and titles.

## 7 Revisions

While the published Construction Standards will govern the evaluation of submissions, where emerging technology, code changes and best practices indicate that revisions are required, BC Housing may require these revisions be incorporated into a particular project.

## 8 Review by BC Housing

Drawings/Documents for BC Housing projects are required at three stages in the BC Housing development review process: Schematic Design stage, Design Development stage and Construction Documents stage. A drawings/documents review will be completed by BC Housing and an acceptance letter will be issued at each stage after all major review **comments** are addressed. During the review process the Owner/Operator and their design consultant should meet with BC Housing to discuss and agree on the issues raised in the drawings/documents review.

A construction cost review will be undertaken by BC Housing at every review stage (i.e. at schematic design, design development and at the construction documents phase.) Refer to BC Housing Cost Target Framework in [Section 1 - General Design Guidelines](#).

BC Housing may elect to engage the **Project Technical Consultant, an independent consultant**, to conduct drawings/documents reviews, comment on compliance with BC Housing's Design Guidelines, and to provide technical advice as required. The **technical consultant** is typically engaged at the Construction Documents review phase of a new construction project but that may vary depending on the complexity of project **and can be engaged at early stage of design or even pre-design stage**. As required by project size and complexity **and BC Housing requirements**, the **project technical consultant will** conduct an inspection of the site during construction, report any observed site conditions which may not have been taken into consideration in preparing the construction documents and confirm the architect's certificate of payment accurately reflecting the contractor's progress claim.

The Project Technical Consultant may also act on behalf of Owner/BC Housing to ensure that all handover items/documents are collected, all deficiencies are corrected, and all building systems and properly commissioned as per the contract documents.

## 9 Tendering Requirements

- .1** Consultants are responsible for the preparation of bidding requirements in accordance with the BC Housing procurement requirements and the Public Tendering Guidelines for Non Profit Housing.
- .2** Consultants are responsible for including the applicable BC Housing Supplementary General Conditions into the contract documents.
- .3** Consultants are responsible for including BC Housing energy and environmental requirements including energy modelling, airtightness testing, applicable rebate and utility incentive, and construction waste management into the scope of the project.
- .4** .4 Depending on the size and complexity of the project, the design and construction team shall be responsible for ensuring that the commissioning requirements are incorporated in the contract documents and all building systems function and operate properly and that integration of the systems are achieved as required by design, regardless of whether a third party commissioning provider is initiated by the Owner or BC Housing. The contractor is ultimately responsible for delivering a fully commissioned building. Consult with BC Housing/ Owner if an independent commissioning provider will be hired for the project. Refer to [BC Housing Building Commissioning Guidelines](#) for detail.
- .5** According to BC Housing Supplementary General Conditions, the Contractor and Subcontractors are responsible for the provision of opportunities for work experience and training in the construction industry for entry level workers to trade apprentices.

The Contractor's work force is required, in locations where such programs exist, to include individuals placed through agencies such as Bladerunners, Tradeworks and Embers that provide ongoing training and support to persons with barriers to employment. Individual placed through these programs will be considered employees of the Contractor Subcontractor. The level of involvement in the program will be developed in consultation with the program's local Project Coordinator.

End of Section

## 01 23 00 - Alternatives

- .1 All substitutions and or alternatives must be pre-approved by the Consultant, BC Housing, and the Owner.
- .2 BC Housing will consider alternative construction materials and assemblies that adjust capital cost provided that:
  - .1 substitute(s) shall be the same type, be capable of performing the same functions, and meet or exceed the standards of quality of the specified product(s),
  - .2 building performance and comfort criteria as described in the *BC Housing Design Guidelines and Construction Standards* are not compromised, and
  - .3 the estimated overall “life cycle cost” remains consistent or is decreased.

The minimum criteria and information has been developed to assist in preparing a “life cycle cost” study for evaluation of alternatives. Life cycle cost is defined in [Introduction to Construction Standards](#) under this section.

- .3 Design consultants must submit the cost and performance data for review by BC Housing. Include the estimated increase or decrease to capital cost, “annual ownership costs”, estimated service life and quality and performance benefits as compared to the Construction Standard.
- .4 Acceptance of any alternative will be based on the value of the estimated cost savings and relevance of the performance benefits to the project.
- .5 The Consultant and the Contractor must coordinate the changes of the work in conjunction with other parts of the work that may be affected. Upon agreement of the changes, the Contractor shall be responsible for cost of changes resulting from the Contractor’s proposed substitutions that affect other parts of the work.

End of Section

## 01 31 00 – Project Meetings

The Consultant shall use the following criteria as a guide in preparing this section.

- .1 Representatives of the Contractor, subcontractors and suppliers attending meetings must be qualified and authorized to act on behalf of the party each represents.
- .2 Schedule a pre-construction meeting within fifteen (15) days of issuance of “Notice to Proceed” letter (design-tender) or within fifteen (15) days of commencement of construction (design-build).
- .3 Schedule and hold regular construction progress meetings, as required to expedite Work, not less than once monthly.
- .4 Attendance for pre-construction and construction progress meetings (but not limited to):
  - .1 Owner’s representative(s) where applicable
  - .2 BC Housing representative(s)
  - .3 Design consultant and engineering consultants
  - .4 Contractor’s project manager
  - .5 Contractor’s superintendent
  - .6 Sustainability Consultant where applicable
  - .7 Contractor’s and Subcontractor’s Sustainability Coordinator where applicable
  - .8 Subcontractors as appropriate to the agenda
  - .9 Suppliers as appropriate to the agenda
  - .10 Commissioning **Provider hired by Owner/ BC Housing**
  - .11 **Project Technical Consultant, if hired**
- .5 Agenda for pre-construction meeting – the following agenda items (but not limited to) should be reviewed:
  - .1 Project description – civic address, site information, project statistics
  - .2 Project team – roles/responsibilities and flow of communication – sponsor, architect, consultants, contractor, BC Housing team, **commissioning provider, project technical consultant, if any**, and support funding partner(s)
  - .3 Construction schedule and milestones
  - .4 Pre-construction documents – see construction contract requirements, e.g., schedule of values, construction schedule, insurance, insurance warranty requirements, bonds, WCB status, building permit status and all other project specific requirements

- .5 Use of the site - hours of operation, site contact information, tree protection, site accessed by the contractor, safety orientation, and all other requirements
  - .6 Contract documents – construction contract, construction drawings, as-built drawings drawings (at substantial completion)
  - .7 Contract administration procedures – recording and distribution of minutes, progress claims, changes, alternates, submittals, shop drawing reviews, reports, meetings, as built drawings, RFI's, release of lien holdback
  - .8 BC Housing sustainability requirements - energy step code level, energy modelling, air tightness testing, incentive and rebate documentation, construction waste management tracking
  - .9 Building envelope – field review, mock ups, window testing, air tightness testing
  - .10 Project close out/substantial performance documents and procedures, building handover guide, commissioning **requirements as per contract and Owner's hired commissioning provider**
  - .11 Signage – BC Housing, **sponsors or funding partners**
  - .12 Temporary and permanent power - utilities, site mobilization and review of Owner and Contractor responsibilities and administrative procedures
  - .13 Sponsor site access and display suite
  - .14 Site security – fencing and video surveillance requirements as per insurance, safety signage
  - .15 Health, safety and emergency response procedures
  - .16 Municipal requirements – building inspectors, permits, landscape and offsite services
  - .17 Fire safety plan
  - .18 Site photographic documentation
  - .19 Third party inspection or testing for quality assurance – e.g. energy modelling, RCABC, MPI, **Owner hired commissioning provider, project technical consultant.**
  - .20 Complete demonstration and training of all mechanical, electrical systems and equipment and bed bug room operation
  - .21 Hazardous Materials Management Tracking Form or inventory spreadsheet – for renovation project
- .6** Agenda for construction progress meeting should follow (but not limited to) the items mentioned:
- .1 Approval of minutes of previous meeting
  - .2 Review of items of significance that could affect progress and/or **project** costs
  - .3 Topics as appropriate to current status of the work and schedule
  - .4 Status of proposed changes
  - .5 Status of submittals including as-built drawings, O&M manuals, waste management tracking, etc.

- .6 Update of Construction Schedule and occupancy permit
  - .7 Update of energy and sustainable requirements and progress
  - .8 Tenant communications for capital/renovation and conversion projects
  - .9 Hand over, training, commissioning activities, and warranty requirements
  - .10 All service connections for water, sewer, storm, drainage and landscape; and utility connections for electricity, gas, communication and data
  - .11 **Deficiency** list from contractor and consultants
- .7** Building Handover Meeting: to be undertaken prior to actual building occupancy. This meeting will focus on final commissioning activities, occupancy and handover, staff training, move-in, closeout submittals, final and warranty inspections. Refer to BC Housing Guide to Building Handover
- .8** Post Occupancy Meetings: the following meetings should be held to discuss the procedures and requirements for overall completion of the project. Refer to [BC Housing Building Commissioning Guidelines](#) and [BC Housing Guide to Building Handover](#).
- .1** Post Completion Review Meeting: to be undertaken within 3 months of project occupancy. The meeting will include analysis of the budget, schedule, scope, change order variances, communication among the stakeholders, risk management and operational issues, along with identifying the successes of the project and the areas for improvement. The commissioning activities and any seasonal testing shall be completed for full operation.
  - .2** Six Month Review Meeting: to be undertaken within 6 months after substantial completion, if required for the project. The purpose is to review the operational log for any deficiencies that to be corrected by the contractor and Owner's training requirements after initial handover.
  - .3** Warranty Review Meeting: within 2 months prior to expiry of warranty.

End of Section

## 01 45 00 – Quality Control

### 1 Inspections and Testing of Materials

- .1** Unless alternate arrangements are made on a project specific basis, the Contractor must engage, coordinate and pay for independent testing and inspections, by agencies approved by the Owner, including but not limited to the following:
  - .1** Exterior wall mock-up inspection including air barrier membrane
  - .2** Window and door pre-delivery lab test (if required)
  - .3** Window and door mock-up inspection
  - .4** Window and door field tests – water penetration
  - .5** Erosion and sediment control
  - .6** Compaction testing of backfill, road base and sub-courses, underslab fill and service trenches
  - .7** Asphalt mix and testing
  - .8** Concrete mix design
  - .9** Concrete testing
  - .10** Masonry veneer wall mock-up inspection
  - .11** Roofing inspection (RCABC)
  - .12** Painting inspection (MPI)
  - .13** Flooring inspection by an independent agency ( if required)
  - .14** Envelope air-leakage testing and suite-level air-leakage testing
- .2** If any defects are revealed during inspection and testing, the appointed agency will request additional inspection and/or testing to ascertain full degree of defect. The Contractor must correct defects and irregularities as advised by the design consultant at no additional cost to the Owner. The Contractor must pay all costs for re-testing and re-inspection.
- .3** Within fifteen (15) days of award of the contract, the Contractor must submit to the design consultant a list of the proposed independent inspection agencies for review and approval by the Owner, the design consultant, and BC Housing if not the Owner.
- .4** Notify the design consultant, Owner and testing agency two (2) days prior to expected time for operations requiring inspection and testing. When tests or inspections cannot be performed, through the fault of the Contractor, the Contractor is responsible for reimbursing the Owner for additional costs incurred.
- .5** Submit PDF electronic copy of inspections and test reports to each: the Owner, design consultant and BC Housing.
- .6** Provide a hardcopy of inspections and test reports on site for all time.

## 2 Mockups

- .1 Construct full-size mockups on site of the following conditions in locations directed by the design consultant. Make changes to the mockups as directed by the design consultant and building envelope consultant. Mockups, once accepted, may be used in the finished work and will serve as a standard against which other work will be judged.
  - .1 Typical exterior wall construction: include exterior wall finish, backup walls, wall cavities, flashings, air seal membranes, insulation, sealants, sheathing and sheathing membranes as applicable
  - .2 Windows: include installed window frame, window anchors, glazing, flashing, air seal membrane connection and sealants as applicable and finished trim. Refer to [Division 08 50 00 - Windows, Side Hinged & Sliding Glass Doors](#)
  - .3 Masonry mockups
  - .4 Complete suite mockup for modular construction and typical construction
  - .5 Exterior cladding mockups
  - .6 Painting, see [Division 09 91 00 - Painting](#)
  - .7 Flooring, see [Division 09 65 00 - Resilient Flooring](#)
- .2 Indicate mockup inspections on the construction schedule. Coordinate with regular site meetings if possible. Inform the BC Housing Inspector and the Consultant at least two (2) days in advance of mockup inspections.
- .3 Provide photographic documentation (if required) for mockups as specified in [Division 01 78 00 - Closeout Submittals](#). Notify the service provider 24 hours before commencing mockup area and do not cover area until after photographs have been taken.

End of Section

# 01 74 19 - Construction Waste Management and Disposal

## 1 General

### .1 CONSTRUCTION DEBRIS AND WASTE MANAGEMENT GOALS FOR ALL PROJECTS.

Ensure a waste management plan implemented for all construction, renovation and demolition (C&D) projects across the Province. A waste management process shall be employed by the Contractor to ensure the generation of as little construction waste as possible and report all waste generated. Refer to BC Housing [livegreen Sustainability Plan](#) and [sustainable waste management](#).

Projects must achieve a C&D waste diversion target of 80% of the total waste generated (by weight) in the Lower Mainland and on Vancouver Island, and 60% for projects elsewhere in the Province. The total waste generated excludes any hazardous or excavated materials, such as asbestos, lead, and earthwork. All materials banned and prohibited from landfills according to the regional regulations shall be recycled.

### .2 REGULATORY REQUIREMENTS

- .1 Conform to applicable codes and regulations for disposal and removal of common (non-hazardous) and hazardous waste. Handle and dispose of all waste materials in accordance with the BC Waste Management Act, Environmental Management Act and Special Regulation, and regional and municipal regulations.
- .2 The hazardous and banned materials should be handled separately from common (non-hazardous) materials and follow WorkSafeBC's regulation. Hazardous materials include but are not limited to asbestos, drywall (banned from disposal), underground storage tanks, polychlorinated biphenyls (PCBs), abandoned chemicals (gasoline, pesticides, flammable and combustible substances), freon from cooling equipment, lead-based paints, smoke detectors, and mercury containing switches. [Appendix A](#) for further information.

### .3 DOCUMENT SUBMITTAL

- .1 Construction Waste Management Plan
- .2 Construction Waste Management Tracking Form

### .4 CONTRACTOR'S RESPONSIBILITIES

- .1 The Contractor is responsible for meeting construction waste diversion target rate and tracking waste diversion rate of all waste generated on site throughout the construction, demolition and land clearing activities including the work carried out by the subcontractors or trades.
- .2 The Contractors shall prevent contamination of materials to be recycled and salvaged and handled materials consistent with requirements for acceptance by designated facilities according to the regional regulations

- .3 The Contractor shall provide on-site instruction of appropriate separation, handling, and recycling to be used by all personnel at the appropriate stage of the Project by using proper signage, educating all workers. Recycling and waste bin areas are to be kept neat and clean and clearly marked in order to avoid contamination of materials.
- .4 The Proponent is required to maintain way-bills, invoices and other documentation confirming that all materials have been transported to the required locations, and to submit this documentation at the completion of the project if requested.

## **.5 WASTE MANAGEMENT PLAN IMPLEMENTATION**

- .1 For all projects, a waste management plan should be developed and prior to demolition and construction stage. A copy of the plan must be submitted to the consultant.
- .2 List of compulsory material to be recycled, shall include, at minimum, the following designated materials:
  - .1 Clean dimensional wood, palette wood
  - .2 Concrete/Brick/Concrete Block/Asphalt
  - .3 Drywall (asbestos free)
  - .4 Scrap metal
  - .5 Corrugated cardboard
- .3 Material Handling: Where space permits, source separation shall be provided. Where materials must be co-mingled the Contractor shall arrange appropriate bins and also arrange for bins to be taken to a processing facility for separation offsite.
- .4 Transportation: The Contractor may engage a haulage subcontractor or make each subcontractor responsible for their own waste, in some cases the Contractor may self haul. In any case compliance with the project requirement is mandatory to all contractors.
- .5 Destination Facilities: Recycled material that are diverted from landfill and sent to alternative to landfills such as recycling facilities or used building material yard. Materials that are sent to landfills or waste-to-energy facilities cannot be reported as recycled material.
- .6 The Construction Waste Management Tracking Form is to be filled out, signed, and submitted, by the Contractor, at following stages:
  - .1 completion of demolition (if applicable);
  - .2 50% construction progress claim; and
  - .3 substantial completion.

For each material salvaged, recycled or disposed from the project, amount (in cubic yard or tonnes or in the case of salvaged item state quantities by number, type and size of items) and the destination (i.e. recycling facility).

# 2 Waste Management Plan

Complete **prior to** start of project.

<b>BCH File Reference #</b>		<b>Company Name:</b>	
<b>Project Name:</b>		<b>Contractor Name:</b>	
<b>Project Address:</b>			
<b>Project Type:</b>	<input type="checkbox"/> New Build <input type="checkbox"/> Renovation <input type="checkbox"/> Demolition	<b>Date Submission:</b>	
<b>Total Area (sq.ft.):</b>		<b>Signature:</b>	

### Site Waste Materials:

Type of Waste Material		Recycle/ Divert from Landfill		Type of Waste Material		Recycle/ Divert from Landfill	
		Yes	No			Yes	No
Wood Product	Clean wood*			Siding Material	Metal siding		
	Painted/Treated Wood				Vinyl Siding		
	Plywood/MDF/laminated				Cement based stucco, plaster		
Gypsum wallboard, Drywall*				Roofing Material	Wood shakes/shingles		
Concrete*					Metal shingles		
Asphalts - paving					Asphalt shingles		
Brick & Masonry units				Flooring Material	Carpet, Underlay		
Aggregates	Sand, Gravel, etc				Ceramic tiles		
	Steel beam, Rebar, etc				Vinyl flooring		
Metal*	Copper pipe			Furnishing	Mattress		
	Aluminum, metal frame				Other furnishing		
Plastic	Trim, packaging, PVC pipes, etc			Plumbing	Fittings (toilet, etc)		
Corrugated cardboard*				Window glass			
EPR† Products	Scrap Boilers, Major appliances			Insulation			
	Electronic waste			Organics (vegetation, trees, stumpage, etc)			
	Light fixture, bulbs			Other			

\* The material must be recycled unless it is deemed as hazardous.

† Extended Producer Responsibility (EPR) is mandated by Recycling Regulation 449/2004 under Environmental Management Act.

### Material Handling and Transportation:

TYPE OF MATERIAL	HANDLING OPTION	HAULING COMPANY NAME
	<input type="checkbox"/> Source separation <input type="checkbox"/> Comingled	
	<input type="checkbox"/> Source separation <input type="checkbox"/> Comingled	
	<input type="checkbox"/> Source separation <input type="checkbox"/> Comingled	
	<input type="checkbox"/> Source separation <input type="checkbox"/> Comingled	

**Designated Facilities:**

TYPE OF MATERIAL	FACILITY TYPE		FACILITY NAME
	<input type="checkbox"/> Recycling Facility	<input type="checkbox"/> Landfill <sup>§</sup>	
	<input type="checkbox"/> Recycling Facility	<input type="checkbox"/> Landfill <sup>§</sup>	
	<input type="checkbox"/> Recycling Facility	<input type="checkbox"/> Landfill <sup>§</sup>	
	<input type="checkbox"/> Recycling Facility	<input type="checkbox"/> Landfill <sup>§</sup>	

§ Materials that are sent to landfill cannot be counted as recycled.

# 3 Waste Management Tracking Form

## Contractor's Waste Management Tracking Form

Project Name: \_\_\_\_\_  
 Project Address: \_\_\_\_\_  
 Project Type:  Demolition  New Construction  Renovation  
 Company Name: \_\_\_\_\_  
 Contractor Name: \_\_\_\_\_

**Declaration:**  
 I certify that this project has implemented a waste management plan and diverted the following quantities of construction, renovation and demolition waste to uses other than landfill. All waste generated from the project (recycled and disposed) are listed below by type of material, receiving facility, amount and diversion ratio. Hazardous and excavated materials (such as asbestos, lead, earthwork) are excluded from this waste management tracking.

Waste measured in:  Metric Tonne  Cubic Yards  
 Signature: \_\_\_\_\_ Submission Date: \_\_\_\_\_

Type of Waste <small>[select from menu]</small>	Date of Haul Day/Month/Year	Recycling Facility	Total Waste Generated	Diversion Rate (%)	Amount Diverted	Comments <small>(i.e. details of specific material such as asphalt shingles)</small>	Weight Receipt Number
<i>EXAMPLE - Siding</i>	<i>28-Feb-18</i>	<i>Recycling Is Us</i>	<i>2</i>	<i>95%</i>	<i>1.9</i>	<i>Vinyl siding</i>	<i>12346</i>
Wood Products					0		
Gypsum Wallboard					0		
Metals					0		
Concrete					0		
Masonry units					0		
Plastic					0		
Roofing (specify)					0		
Siding (specify)					0		
Flooring (specify)					0		
Window Glass					0		
Insulation					0		
Appliances					0		
Misc Furnishings					0		
Mixed C&D waste					0		
Green waste					0		
Cardboard/paper					0		
Other (specify)					0		

Total Quantity of Waste Generated from the Project: 0.0  
 Total Quantity of Waste Diverted from Landfill: 0  
 Percentage of Waste Diverted: NaN %



**Note:**

1. Recycling facility is the final destination of the material, and is different from hauling company.
2. Material sent to landfill is considered to have a diversion rate of 0% with fully recycled/salvaged waste materials equivalent to 100%.
3. Contact the Recycling Council of BC for information regarding recycling facilities across the province ([www.rcbc.bc.ca](http://www.rcbc.bc.ca), 1-800-667-4321, [hotline@rcbc.bc.ca](mailto:hotline@rcbc.bc.ca))

End of Section

# 01 78 00 - Closeout Submittals

## 1 General

- .1** Typically, BC Housing utilizes CCDC form of contracts, which covers closeout requirements for Contractors. However, if any forms of contracts are used, the following requirements, in addition to what is stated in those particular contracts, will apply.
- .2** The closeout documents shall be prepared by the Contractor and submitted to the Consultant, Owner, and BC Housing for an initial review prior to the completion of the project. Following this review and responding to the comments, the Contractor must submit the completed documents to the Owner no later than thirty (30) business days after the certificate of completion.
- .3** A deficiency holdback amount shall be stated in the contract documents for items not submitted on time and deficiencies in the as-built drawings and operating and maintenance manuals.
- .4** The Contractor shall prepare a fire safety plan and documentations in accordance with the current BC Fire Code and the Local Fire Bylaw, unless otherwise specified by the Owner/Operator.
- .5** Consideration should be given to the size and complexity of the project as well as location and costs to determine if comprehensive third party photo documentation of construction progress and as-built conditions by the contractor is required or applicable.
- .6** If the photographic documentation is required for the project, the following requirements must be incorporated:
  - .1** All documentation services shall track at regular intervals (typically monthly) throughout the construction in chronological order, in addition, special dates like milestones, mockups, testing, inspection, commencement, completion, miscellaneous events such as materials arriving on site, waste handling/recycling as determined by Owner/Consultant, and at handover training on building systems. The documentation shall include date, electronic indexing, navigation through architectural plans, storage and online access.
  - .2** Exterior progress documentations: include all elevations and major site features like underground utilities, soil and sediment control, adjacent buildings, blindside property line excavation, reinforcing drainage, concrete wall construction, outside progression of building envelope, roof construction and more.
  - .3** Interior progress documentations: include interior improvements by areas like interior wall framing, insulation, air/vapour barrier, and finishes, envelope and suite-level air-tightness details, flooring installation, interior finishes, millwork and more.
  - .4** Overlapping images of all in-slab utilities within the building and all finished systems located in the walls and ceilings for mechanical, electrical, plumbing and all other systems.
  - .5** Upon completion of the Project, final copies of the documentation in all "as-built" conditions (the "Permanent Record") with the indexing and navigation system embedded (and active) are

to be provided in an electronic media format, such flash hard-drive or equivalent. Submit a total of 2 copies - 1 each to the Owner and BC Housing. Make sure "as-built" condition shows actual physical conditions, completely and accurately including all changes during construction.

- .6 Provide online site access available for any standard internet connection for multiple users (such as Owner, BC Housing, Contractor, Architect, design consultants, or anyone requested by the Owner) – simultaneous use and access to clear, focused, high resolution photographs (organized by date, time and location) that can be enlarged and individually printed as required. Technical support related to using the system should be provided during the construction and 2 years after the substantial completion.

## 2 Closeout Requirements

### .1 AS BUILT DRAWINGS AND SPECIFICATIONS

- .1 The design consultant will provide one (1) set of white prints of all contract drawings for the sole purpose of recording all "as-built" conditions. The Contractor must clearly identify them as "as built drawings" and have them available at all times and at each regular project progress site meeting for inspection by the Design Consultant, Consultant Inspector (if applicable), and BC Housing.
- .2 As work progresses, the Contractor must record clearly and indelibly in red pencil all "as-built" deviations from the contract documents as a result of changed site conditions, various directives by addenda, correspondence, site clarifications, site instructions, change orders, shop drawings and changes required by authorities having jurisdiction. All documentation that is referenced must be included and cross referenced in the as built drawings. Present as-built prints for scrutiny at each project meeting and as may be required by the Consultant.
- .3 Mark the contract drawings or shop drawings, whichever is most capable of showing actual physical conditions, completely and accurately. If shop drawings are marked, show cross reference on the contract drawings.
- .4 Upon completion of the Work, the Contractor shall employ the design consultants to produce one (1) copy of signed and certified white print and two (2) sets in high quality indexed electronic format (e.g. CD, USB) for both PDF and CAD drawings that include all as built conditions noted on the Contractor's as-built drawings and PDF specifications.
- .5 The recorded deviations include, in general but are not necessarily limited to, items that are hidden from view, items of major importance to future operations, maintenance, alterations and additions.
- .6 The title sheet shall include a complete list of all drawings. Each drawing shall include a graphic symbol that identifies all as built revisions, cross referenced to a date in the drawing issue portion of the title block.
- .7 The Contractor must sign each drawing and provide one (1) Certificate of Record (below in Article 2.2) for the drawing set as illustrated in the following paragraphs, signed by persons authorized to sign on behalf of the Contractor.
- .8 Acceptance of the as-built drawings and specifications shall be subject to the review and approval of the Consultant(s) and BC Housing. The Consultant(s) shall provide all the comments to the Contractor within 15 business days after receipt of these documents.

- .9 Include two (2) copies of specifications with contract modifications, addenda, change orders and site instructions in PDF on high quality indexed electronic format.
- .10 Following this review and responding to the comments, the Contractor must submit the completed documents to the Owner no later than thirty (30) business days after the certificate of completion.

## .2 CERTIFICATE OF RECORD - AS-BUILT DRAWINGS

**I/We (name of Contractor) hereby certify** that the set of as-built drawings attached hereto, comprised of (-) sheets, is a complete and total record of the building(s) as constructed.

We further certify that the drawings show accurately all structural details, all mechanical and electrical services, exposed or hidden and that the Owner may fully rely on their accuracy in any future contemplated repairs, modifications or additions to this work.

Signed by

Contractor: \_\_\_\_\_

Name of Contractor \_\_\_\_\_

Per: \_\_\_\_\_

Date: \_\_\_\_\_

Witnessed by: \_\_\_\_\_

Date: \_\_\_\_\_

## .3 CONSTRUCTION WASTE MANAGEMENT TRACKING SHEET

The Contractor must complete the "Construction Waste Management Reporting Sheet" as part of the closeout requirements and outlined in Appendix C. The form is to be completed by the Contractor, signed, and submitted to BC Housing at the following stage: completion of demolition (if applicable), 50% construction progress claim, and substantial completion. Refer to [Energy and Environmental Design](#) section for additional information.

## .4 UTILITY INCENTIVE AND REBATE DOCUMENTATION

The contractor will provide all documentation necessary to apply for all applicable incentives within 30 days of equipment purchase to the BC Housing staff responsible for managing the project. The related documents are, but not limited to, appliance invoices, lighting invoices, exhaust fan invoices, boiler invoices, and any related mechanical equipment invoices. Invoices must state the manufacturer, model, unit price, quantity, and physical installation address. For the appliances, lighting, and exhaust fans, a suite or unit breakdown should be provided outlining corresponding

lighting and appliances, including make, model type and confirmation of ENERGY STAR® rating. Refer to [Energy and Environmental Design](#) for additional information.

### **.5 HAZARDOUS MATERIAL INVENTORY SPREADSHEET**

For renovation projects, the contractor will update the existing hazardous material inventory spreadsheet and submit to the BC Housing staff responsible for managing the project.

## **3 Contractor: Operating and Maintenance Manuals**

Provide a detailed index and a summary checklist of items to be maintained, including required preventative maintenance time scale. Also highlight the methodology and scope which can be readily cut and pasted onto work orders or separate scopes of work for bid purposes and/or instruction to in-house maintenance staff.

- .1** Manuals are to contain pertinent care, maintenance, operational and installation information for all building materials, finishes, components, equipment and systems. Instructions in the manuals to be in plain language so as to guide the Owner in the proper operation and maintenance of the building.
- .2** Manuals shall be prepared by experienced and qualified staff or consultants. Acceptance of the maintenance manuals shall be subject to the review and approval of the Consultant and BC Housing.
- .3** Provide information for future operating staff to understand and optimally operate the commissioned systems and how to effectively recommission the systems to prolong the service life, decrease energy consumption, and reduce operational, maintenance and replacement cost.

### **.1 Requirements**

- .1** Submit a draft copy of the tables of contents for the manuals 30 days prior to the date of Substantial Performance of the Work, for review by the Consultant.
- .2** Submit completed maintenance manuals with application for Substantial Performance, for review by the Consultant. Include an indexed demonstration video of all mechanical, electrical systems and electrically-operated devices, bed-bug room operation and any other systems (requested by the Consultant) to the Owner's operating and maintenance staff and any training required by the specifications, to the Owner's satisfaction.
- .3** Submit one (1) set of final hardcopy maintenance, operating and instruction manuals and two (2) sets in high quality indexed electronic format (e.g. CD, USB) PDF to the Owner no later than thirty (30) business days after the certificate of completion is issued.
- .4** Complete reports including a balancing report for all mechanical systems and certification by all testing, cleaning or inspection authorities as specified in the contract documents.
- .5** Include summary of items covered by change orders.
- .6** Include summary of equipment and systems that require periodic filter change, manufacturer's inspection (if required) and city inspection (if any) and provide the schedule for maintenance staff.

- .7 Provide a list of spare parts for the equipment and system that was provided as per contract documents.
- .8 Include any equipment supplied by the Owner, separate to the contract.
- .9 Include development permit, building permit, occupancy permit and letters of assurance.
- .10 Include all warranty information, contact information for inquiries, warranty period start dates, expiry dates, and a brief description of any commentary related to warranty coverage or limitations. Warranty information is to be compiled into one document that can be easily referenced by the Owner.
- .11 Include performance bond and/or maintenance bonds.
- .12 Include Letter of Credit (if applicable) issued to cover the performance and completion of site services.
- .13 Format: Bind manual contents into hard plastic coated three-ring binders, complete with coloured plastic tabs organizing contents into applicable categories of Work, based on the specifications for the project. Label the cover and spine of the manuals with the name of the project and manual contents. Descriptions and lists are to be neatly typed or printed on 216 mm x 280 mm (8" x11") heavy bond paper.

## **.2 Organization of Manuals**

### **.1 Section 1.0 – Directory**

- .1 Provide a directory listing the names, addresses, telephone and facsimile numbers of Consultant, Engineering Consultants, Contractor, Subcontractors, major equipment, product and equipment suppliers and service contract providers (e.g., alarm system, elevator, mechanical). Include emergency contact names. Also outline duration of warranties, including start and expiry dates.

### **.2 Section 2.0 – List of Drawings and Specifications**

- .1 Provide a complete list of drawings and specifications. Provide list of shop drawings and test reports for the project in their own sections.

### **.3 Section 3.0 – Architectural (Including Landscaping, Building Envelope, Finishes)**

- .1 Provide care, cleaning and recommended maintenance instructions for finishes and materials as specified.
- .2 Provide operation and maintenance instructions for equipment such as (but not limited to) overhead doors, landscape irrigation systems and elevators. Provide descriptive and technical data, maintenance and operating procedures, wiring diagrams, spare parts lists, name of service representative, suppliers for replacement parts, trouble shooting data and preventive maintenance program complete with maintenance and renewal checklists.
- .3 Submit a backup copy of the elevator control system software.
- .4 Provide copy of finish hardware schedule, paint schedules (interior and exterior), and caulking and sealant schedules, complete with the manufacturer, supplier and identification names and numbers.
- .5 Provide inspection and approval certificates from authorities having jurisdiction.

- .6 Provide RCABC and MPI Guarantee and documentation.
- .7 Provide a copy of all warranty and guarantee certificates as specified.
- .8 Provide a copy of the Homeowner Protection Office (HPO) Building Envelope Renovation Schedule, where applicable.
- .9 Submit a list of chattels, if any, including make, model and serial number provided by the Contractor for the project.
- .10 Provide the copy of air tightness testing and any energy and sustainable certification for the project.

#### .4 Section 4.0 – Mechanical

Provide an index with the following headings:

- .1 Mechanical Drawing List including all shop drawings (sprinkler, variation isolations, valves tag and flow diagram, air handing unit / make-up air unit, HRVs, fan coils and grille, radiant heating (if provided), sump pumps and all other pumps, plumbing fixtures and drains, heat pumps or any preheating systems, control shop drawings, and any other)
- .2 Description of Systems
- .3 Mechanical System service, maintenance, operation and troubleshooting data
- .4 Required preventative maintenance schedule, belt schedule, filter schedule, and lubrication schedule for all equipment and systems
- .5 Subtrade and supplier list equipment repair manuals
- .6 List of spare parts provided as per contract documents
- .7 Chemical treatment certificates, hydrostatic and air test certificates
- .8 Final **3rd party independent** testing adjusting and balancing reports
- .9 Valve tag schedule, piping colour code
- .10 Equipment start up reports and operating instruction for each systems and components equipment performance verification test results, and **contractor's pre-functional testing reports outlined in [Section 01 91 00 Building Commissioning](#)**
- .11 **Functional testing reports and final commissioning tracking checklist showing the completion of commissioning activities**
- .12 Guarantee certificate, final inspection certificates, warrantee certificates
- .13 Controls "as built" drawings, control schematics for equipment/systems and sequence of operation
- .14 WHMIS Information
- .15 Training manuals
- .16 **Documentation of all equipment and system information, such as model number, serial number, engineer's review, inspections by authority having jurisdiction**

**.17 Final commissioning report from the commissioning provider or contractor's independent commissioning agent**

**.18** Under each of the above headings, provide the following information, arranged under separate tabs, for each system and major piece of equipment:

**.1 Descriptive and Technical Data**

Include detailed description of the system and components, an explanation of how each component interfaces with others and the location of each thermostat and all controls.

**.2 Operating Procedures**

- .1 Provide complete and detailed operation of each major component
- .2 Include starting procedure, exact switch and control location
- .3 Describe operation of component controls, changes required for summer or winter operation and method of making changes
- .4 Describe trouble shooting sequence when settings can not be maintained
- .5 Describe safe guards to check if equipment goes off line
- .6 Describe fire protection and smoke control

**.3 Maintenance and Lubrication**

- .1 Provide detailed preventive maintenance schedule for each of the major components including daily, weekly, monthly, semi-annual and yearly checks and tasks
- .2 Describe lubrication and maintenance procedures for equipment components such as bearings, drives, motors and filters. Include recommended lubricants
- .3 Compile this information for each typical piece of equipment
- .4 Provide a belt schedule

**.4 List of Equipment Supplier, Subcontractors and Servicing Companies**

- .1 Provide a complete list of local equipment Supplier of parts, Subcontractors and reputable and qualified Service Companies, including address and telephone numbers
- .2 Outline procedures for purchasing parts and equipment
- .3 Provide a detailed description including drawings, dimensions, parts list and repair manual for each piece of equipment specified

**.5 Certification and Test Results**

Include copies of the following:

- .1 Pre-operational cleaning reports and chemical treatment
- .2 Hydrostatic and air tests performed on piping systems
- .3 Equipment alignment certificates
- .4 Balancing reports for air and water systems

- .5 Valve tag identification schedule including location, service and normal position
- .6 Pipe colour code
- .7 Inspection and approval certificates for plumbing and gas systems and heating and ventilation systems
- .8 Equipment startup reports
- .9 Warranty certificates

**.6 Shop Drawings**

Include copy of all reviewed shop drawings.

**.5 Section 5.0 – Electrical**

Provide an index with the following headings:

- .1 Switch gear and distribution
- .2 Lighting fixtures and lamps
- .3 Fire alarm system
- .4 Emergency generator system
- .5 Mechanical motor control equipment
- .6 Communication systems
- .7 Security system
- .8 Personal call system (if any)
- .9 Fire safety plan
- .10 Integrated system testing report outlined in Section 01 91 00 Building Commissioning**
- .11 Any further testing reports outlined in Section 01 91 00 Building Commissioning**
- .12 Under each of the above headings, provide the following information, arranged under separate tabs, for each system and major piece of equipment:
  - .1 Descriptive and technical data
  - .2 Maintenance and operating procedures
  - .3 Wiring diagrams
  - .4 Spare parts list
  - .5 Service representatives
  - .6 Suppliers for replacement parts
  - .7 Test results and final vitrification reports
  - .8 Certifications and warranties
  - .9 Troubleshooting, operational and performance data
  - .10 Preventive maintenance program complete with checklists

**.3 Schedule of Maintenance Manuals Submittals**

- .1 The Contractor shall ensure that all manufacturer product information required by the Owner to maintain the building is included in the Maintenance Manuals.
- .2 Include a copy of all reviewed shop drawings as noted in the Schedule of Maintenance Manual Submittals, or as requested by the Consultant.
- .3 The following table is a checklist of typical Maintenance Manual contents:

**SCHEDULE OF MAINTENANCE MANUAL SUBMITTALS | SPECIFICATION DIVISIONS: 3 - 13**

TRADE (1)	SECTION NO. (2)	CONTACTS (3)	SHOP DRAWINGS & PRODUCT DATA (4)	INSTALLATION INSTRUCTIONS (5)	WARRANTIES & GUARANTEES (6)	SUGGESTED MAINTENANCE INTERVALS (7)	CARE & CLEANING (8)	HARDWARE SCHEDULE (9)	COLOUR/PATTERN (10)
Concrete	03 30 00	•	•						
Masonry	04 20 00	•	•						
Metal	05 50 00	•	•						
Rough Carpentry	06 10 00	•	•						
Finish Carpentry	06 20 00	•	•		•	•	•		
Dampproofing & Waterproofing	07 10 00	•	•	•	•	•			
Thermal Protection	07 21 00	•	•		•	•			
Asphalt Shingle	07 31 13	•	•	•	•	•	•		•
Vinyl Siding	07 46 33	•	•	•	•	•	•		•
Fibre Cement Siding	07 46 46	•	•	•	•	•	•		•
Membrane Roofing	07 50 00	•	•	•	•	•	•		•
Roof Accessories	07 72 00	•	•	•			•		
Joint Sealants	07 92 00			•	•	•			•
Metal Doors & Frames	08 11 00	•	•	•	•		•		
Wood Doors & Frames	08 14 00	•			•	•	•		
Overhead Parkade Doors	08 33 23	•	•	•	•	•	•	•	
Aluminum Entrances & Storefronts	08 41 00	•	•		•		•		
Windows, Side Hinged and Sliding Glass Doors	08 50 00	•	•		•	•	•	•	
Finish Hardware	08 70 00	•	•	•	•	•	•	•	•
Stucco	09 24 23	•	•	•	•	•	•		•
Gypsum Wallboard	09 28 00	•			•				
Ceramic Tile	09 30 00	•	•	•	•	•	•		•
Resilient Flooring	09 65 00	•	•		•	•	•		•
Carpet	09 68 00	•	•		•	•	•		•
Painting	09 91 00	•			•		•		•
Specialties	10 00 00	•	•		•		•		
Plastic Laminate Tub Enclosures	10 28 19	•					•		
Residential Equipment	11 30 00	•	•	•	•		•		
Window Treatments	12 20 00	•	•		•		•		
Manufactured Wood Casework	12 32 00	•	•	•	•	•	•		
Heat Treatment	13 20 00	•	•	•	•				

**SCHEDULE OF MAINTENANCE MANUAL SUBMITTALS | SPECIFICATION DIVISIONS: 14 - 26**

TRADE (1)	SECTION NO. (2)	CONTACT (3)	SHOP DRAWINGS (4) WARRANTIES & GUARANTIES (6)	DESCRIPTION OF OPERATION OF SYSTEM AND TECHNICAL DATA (11)	MAINTENANCE & OPERATING INSTRUCTIONS (12)	TESTING, ADJUSTING AND BALANCING REPORTS (13) INSPECTION & TEST CERTIFICATES (14)	WIRING DIAGRAMS (15)	LIST OF SUPPLIERS AND MODEL NUMBERS (16)	SPARE PARTS LIST AND SOURCE (17)
Elevators	14 20 00	•	•	•	•	•	•	•	•
Fire Protection System	21 00 00	•	•	•	•	•	•	•	•
Plumbing	22 00 00	•	•	•	•	•		•	•
Heating, Ventilation and Air Conditioning	23 00 00	•	•	•	•	•	•	•	•
Electrical	26 00 00	•	•	•	•	•	•	•	•
Communications	27 00 00	•	•	•	•	•	•	•	•

**SCHEDULE OF MAINTENANCE MANUAL SUBMITTALS | SPECIFICATION DIVISION: 32**

TRADE (1)	SECTION NO. (2)	CONTACTS (3)	SHOP DRAWINGS & PRODUCT DATA (4)	INSTALLATION INSTRUCTIONS (5)	WARRANTIES & GUARANTEES (6)	SUGGESTED MAINTENANCE INTERVALS (7)	CARE & CLEANING (8)	HARDWARE SCHEDULE (9)	COLOUR/PATTERN (10)
Planting	32 90 00	•				•			

Notes:

- (1) Trade listing.
- (2) Section listing in BC Housing Construction Standards.
- (3) Submit Subcontractor or Supplier's name, address, telephone number and emergency contact.
- (4) Submit copy of reviewed shop drawings or Product data as specified. Submit engineered shop drawings where specified.
- (5) Submit installation instructions for products which BCH may be removing and reinstalling.
- (6) Submit warranties and guarantees as called for in the specifications. Warranties and guarantees to be signed by an authorized signing authority.
- (7) Submit list of required maintenance intervals for materials covered under warranties and guarantees.
- (8) Submit manufacturer's instructions covering the care, cleaning and maintenance of specified finishes.
- (9) Submit a complete copy of the hardware schedule in accordance with the specifications.
- (10) Submit a complete listing of colour / pattern products and locations.
- (11) Submit descriptions and operation of major components and systems, including seasonal variations, interface with other components, and operation of controls.
- (12) Submit a detailed preventative maintenance schedule, operating instructions and complete trouble shooting checklists. Include schedules of tasks, frequency, tools required and task time.
- (13) Submit testing, adjusting and balancing reports as specified.
- (14) Submit inspection and test certificates issued by authorities having jurisdiction and equipment manufacturers. Submit performance data sheets after commissioning is complete.
- (15) Submit wiring diagrams and schematics as specified.
- (16) Submit a complete list of equipment and fixtures installed as part of the Work complete with make and model numbers.
- (17) Submit a complete list of spare parts for equipment, sources and approximate replacement costs.

## 4 Fire Safety Plan

- .1** Unless otherwise specified by the Owner/Operator, the Contractor shall engage a qualified person or company to prepare a fire safety plan and documents in accordance with the current requirements of the Local Fire authority, BC Fire Code, and any other applicable legislation at least 45 days before the target substantial completion.
- .2** The fire safety plan be kept in a location designated by the BC Code and local authorities having jurisdiction. The design team shall review this requirement at the design development stage with the fire department to confirm if a secure location in the lobby will be required. Refer to [Division 21 00 00 – Fire Protection](#).
- .3** The fire safety plan and related documents required by the local authorities shall be submitted to the Prime Consultant, Owner, and local Fire Department or other authorities having jurisdiction for review and approval, and if needed, make all necessary modifications to the documents to satisfy the requirements of the local authority. It is expected that this plan will go beyond the basic requirements of the Fire Code to include additional sections on Earthquake Preparedness/Response and Major Incident Response.
- .4** Upon completion, the Contractor shall submit two (2) hard copies in 3 ring binders with printed and laminated tabs for each section, and one (1) copy in electronic format using .doc or .docx (Microsoft Word) for text and .dwg, dxf or .vsd for site/building plans.
- .5** The Contractor is responsible for completing (including costs) all application and registration process, including permits in all jurisdictions where required.

## 5 Operator: Maintenance and Renewal Plan

- .1** The Contractor shall provide the Operating and Maintenance (O&M) manuals and project documents to allow the Owner/Operator to prepare a Maintenance and Renewals (M&R) Plan for the project.
- .2** The Owner/Operator shall engage qualified personnel to prepare the M&R Plan. The M&R Plan shall be based on the maintenance manual and information supplied by the Contractor. The Plan shall include all necessary information to allow the Owner to conduct routine maintenance and meet the Owner's obligations under any warranties provided for the Work.
- .3** The Owner shall submit the following:
  - .1** Draft M&R Plan to BC Housing within thirty (30) business days after receiving the Contractor's Maintenance O&M manual of the building for review by BC Housing and the Consultant.
  - .2** One (1) hard copy (three ring binder format) along with two (2) copies in indexed electronic format (CD, USB) within fifteen (15) business days of written approval of the draft M&R Plan.
  - .3** The M&R Plan shall include the following:

- .1 contact list providing telephone numbers, fax numbers and addresses, for the Consultants, and Sub-Consultants, Contractor and all Sub-contractors and major suppliers
  - .2 overview of necessity and use of the M&R Plan and glossary of terms utilized in the documentation
  - .3 warranties for all materials, systems and equipment in the building, related maintenance requirements and, if applicable, Maintenance Bonds or Letters of Credit issued to cover the performance of particular building components
  - .4 overview of building envelope principles utilized in the design of the building's exterior walls, building envelope assemblies and components and associated maintenance requirements
  - .5 overview of mechanical, electrical, elevator and control systems, components and associated maintenance requirements. The recommendations of requirement of any service contracts that may increase the building performance
  - .6 information needed for building maintenance, operation/recommissioning of building systems and cost of future replacement of building components
- .4** Maintenance and renewal/replacement planning schedule including the following elements:
- .1 11" x17" format table with building element to be maintained or replaced along with a description of the task to be carried out including architectural, elevator, mechanical and electrical elements over a 30 year planning period. Include estimated cost of each maintenance task and element to be replaced at its end of life
  - .2 note frequency of maintenance listing the specific year of maintenance renewal and replacement over a minimum 30 year span along with the associated cost of maintenance and replacement
  - .3 note key dates from the Home Warranty or warranties for manufactured items and the level of expertise required for each inspection
- .5** Include an annual inspection checklist and maintenance checklist (routine, annual, or cyclical) outlining items to be inspected, based on the maintenance schedule. Refer to Housing Provider Kit, Building Handover Guide, Maintenance Guide.
- .6** The following completed project documents shall be included:
- .1 Substantial completion certificate and completion certificate
  - .2 AIBC Document Six - Canadian Standard Form of Agreement for Architectural Services
  - .3 CCDC contract - contract between Owner and Contractor
  - .4 Municipal building permit, occupancy permit and letters of assurance
  - .5 Copy of performance bond
  - .6 As-built drawings and specifications
  - .7 Building commissioning information

End of Section

# 01 91 00 – Building Commissioning

## 1 General

- .1 Commissioning is an integrated set of activities intended to ensure that a project meets both the Owner's project requirements (OPR) and the operational needs. The Owner's goals and objectives should drive the project team and be documented in OPR at an early phase of development. The value of commissioning lies in its power to verify and document that all building systems and assemblies are planned, designed, installed, tested, operated and maintained to meet those goals and objectives.
- .2 All BC Housing funded and financed projects including both new development and renovation/ capital projects shall require commissioning. Refer to [BC Housing Building Commissioning Guidelines](#).
- .3 The level and depth of commissioning required for the project will be determined by the size and complexity of the project itself and by the needs defined in the OPR.
- .4 The general contractor is ultimately responsible for ensuring that all building systems and integration of the systems are operating and functioning as intended in the contract documents, regardless of whether a 3rd party independent Commissioning Provider (CxP) is initiated by the Owner or BC Housing.
- .5 The consultant team shall be responsible for ensuring that the contract documents are in accordance with the OPR, basis of design, meet BC Housing Design Guidelines, building code, by-law requirements and authorities having jurisdiction, and outlining the commissioning requirements and process for all building systems and integration of systems.
- .6 The consultant team shall consult the re-zoning and building commissioning by-law requirements and BC Housing/Owner before establishing the commissioning activities for the project. Regardless, a third- party commissioning provider is hired by the Owner or BC Housing the consultant team shall oversee the commissioning activities confirming that all building systems and integration of systems are functioning, and all testing and contractor's commissioning documentations are submitted at substantial completion and close-out phase.
- .7 There are four options (Article 2.2) of implementing the 3rd party independent commissioning process initiated by the Owner/BC Housing. The Owner/BC Housing is responsible for choosing one of the four options based upon the local re-zoning by-laws, project classification and size/ complexity of the building to complete the commissioning process at a minimum.
- .8 Refer to [BC Housing Building Commissioning Guidelines](#) for details.

## 2 Project Commissioning Activities and Responsibilities

### .1 CONSULTANT AND CONTRACTOR COMMISSIONING RESPONSIBILITIES

#### .1 Mechanical, HVAC, and Plumbing Systems Commissioning

- .1 The commissioning of the mechanical, HVAC, and plumbing systems is the responsibility of the mechanical contractor. At a minimum, the mechanical contractor is required to hire an independent testing and balancing (TAB) agency to meet contract requirements regardless of a project size.
- .2 The mechanical consultant is responsible to ensure that all commissioning items, related tests (outlined below) are incorporated in the contract documents and final testing reports are conducted at the end. The mechanical consultant is to review and update the list of the tests as necessary based on the complexity of the building and to meet the local codes and authority having jurisdiction.
- .3 At a minimum, the mechanical contractor (or an independent agency under the mechanical contractor, if required by the contract documents) performs the following tests and submits the completed reports at or before substantial completion:
  - Backflow inspection test
  - Water main chlorination test report
  - Piping pressure test
  - Hydronic system flushing and chemical treatment/glycol test report
  - Manufacturer start-up of equipment where required (i.e. boiler, chiller, split AC/heat pumps, variable frequency drives, etc.)
  - Fire damper drop test
  - Megger test of heat tracing
  - Parkade gas detector test and calibration
  - Sprinkler system verification and sign-off
  - Testing, adjusting, and balancing report
- .4 These tests and any other related tests as per the contract documents are typically the pre-requisites for performing pre-functional and functional testing for commissioning of the mechanical systems.
- .5 The Owner/BC Housing will retain a 3rd party Commissioning Provider (CxP) to perform the process in Options 1, 2, and 3 as outlined in Article 2.2 Third Party Commissioning Provider Scope and Responsibilities for overseeing pre-functional testing, performing functional and seasonal testing, coordinating owner's demonstration, reviewing O&M documentation, and warranty reviews. In Option 4, the Owner/BC Housing may not require to retain a CxP directly but the mechanical contractor will hire their own mechanical commissioning agency (CxAg) to carry out the commissioning tasks.
- .6 Depending on the complexity of the project, if the commissioning activities outlined in

above paragraph (i.e. pre-functional and functional testing, owner's demonstration, O&M documentation review, seasonal testing, and warranty reviews) are to be performed and completed by the mechanical contractor's 3rd party independent commissioning agency for Option 1, 2, and 3, the consultant must consult with the Owner and BC Housing for prior approval no later than Design Development stage. In such event, the Owner/BC Housing may engage a 3rd party CxP to oversee the process only.

## **.2 Electrical Systems Commissioning**

- .1** The commissioning of the electrical systems is the responsibility of the electrical contractor.
- .2** The electrical consultant is responsible to ensure that all commissioning items, related tests (outlined below) are incorporated in the contract documents and final testing reports are conducted at the end. The electrical consultant is to review and update as necessary based on complexity of the building and to meet the local codes and authority having jurisdiction.
- .3** At a minimum, the contractor performs the following tests and submits the completed reports at or before substantial completion:
  - Insulation resistance testing of feeders, transformers, busbars, etc.
  - Voltage and Current readings of each equipment (motors, transformers, etc.) operating at full load
  - Operational test to demonstrate the proper operation of controls and interlocks
  - Ground testing
  - Phase load balance
  - Lighting control systems
  - Protective device coordination and fault studies
  - Infra-red scan for each feeder termination
  - Building Distribution system
  - Low Voltage Switchgear and Motor Controls (600 volts and below)
  - Power factor readings
  - Intrusion detection and access control testing
  - Generator and transfer switch start-up report (if applicable)
  - UPS start-up report
  - Fire alarm verification per ULC 537

## **.3 Building Envelope Systems Commissioning**

- .1** The commissioning of the building envelope systems is the responsibility of the general contractor.
- .2** The architect is responsible for overseeing the envelope commissioning. Separate envelope commissioning may be required based on by-law or funding partner's (such as health

authority, non-profit society, CMHC, etc.) requirements (i.e. if pursuing LEED v4 Enhanced Commissioning Option 2, or other 3rd party certification requirements).

- .3 All buildings shall meet or exceed the whole building performance targets identified in [Section 2 - Energy and Environmental Design](#). These targets shall be verified through mandatory building and energy modelling as per the Provincial Energy Step Code. Energy modelling shall be performed in all types of BC Housing projects and results shall be submitted to the architect at schematic design, building permit and as-built stages.
- .4 The architect is to ensure the following:
  - .1 The envelope-related efficiency measures (insulation values, window-to-wall ratios, glazing characteristics including overall U-value, performance rating and solar heat gain coefficient, shading, and window operability) are included in the plans and specifications. Coordination with the energy modeller is required to identify options for envelope insulation values, building orientation, and shading—other variables that can affect load and are most effectively evaluated during the early stage of design.
  - .2 The architect includes the airtightness testing requirements in the contract document and ensures that the testing is submitted by the contractor at substantial completion. Continuity of the air barrier and insulation layer shall be clearly illustrated on drawings and details with special attention paid to typical air leakage and thermal bridge pathways such as interface between design elements including parapets, balconies, window edges, walls and foundations. Refer to [Section 2 - Energy and Environmental Design](#).
  - .3 The windows must be carefully integrated into the entire envelope system. The architect ensures that the air barrier and insulation continuity are maintained at the window/wall interfaces, and that thermal bridging is minimized.
  - .4 The contractor performs the pre-installation laboratory tests (as required) and field tests of the fenestration products as outlined in [Division: 08 50 00 - Windows, Side Hinged and Sliding Glass Doors](#). The architect ensures that the testing reports meet the contract documents and submits to Owner at substantial completion.

#### **.4 Architectural Systems Commissioning**

- .1 The general contractor is responsible for commissioning architectural systems, with a focus on systems that may be integrated into life safety systems, such as fire shutters, door hardware, operable louvres, and other systems.
- .2 The architect shall ensure that these items are included in the contract document and related test results/reports are collected at substantial completion.

#### **.5 Elevator Systems Commissioning**

- .1 The commissioning of the elevator systems is the responsibility of the general contractor.
- .2 The architect shall ensure that the elevator commissioning requirements are included in the contract document and meet the building code requirements. The architect will collect all the testing results at or before at substantial completion.

#### **.6 Integrated Systems Testing**

- .1 The general contractor is responsible for coordinating integrated systems testing to meet

the requirements of CAN/ULC S1001 Integrated Systems Testing of Fire Protection and Life Safety Systems. Time is to be allocated in the construction schedule for these tests, and the general contractor is to ensure that the key sub-trades are a part of this testing.

- .2 Pre-requisites for integrated systems testing are individual verification reports such as fire alarm verification report, sprinkler sign off, elevator sign off, fire/smoke/life safety fan balancing reports, and others.
- .3 The intent is not to replicate the tests of each device, but to test the operation of the life safety system as a whole. Examples include but are not limited to the following:
  - Fan shutdown on duct smoke detector
  - Activation of fans (stair pressurization, vestibule pressurization, smoke evacuation) on fire alarm
  - Successful integration of sprinkler devices, pre-action systems, etc.
  - Proper operation of door hold-open devices, mag locks, fire shutters, etc.
  - Elevator recall to home and alternate home floors
  - Operation of life safety systems upon loss of power or on generator power
- .4 The architect shall ensure that these items are included in the contract document and related test results/reports are collected at substantial completion.
- .5 Based on the level of 3rd party commissioning hired by the Owner/BC Housing required for the project, the CxP may require to witness these tests. Refer to [Article 2.2: Third Party Commissioning Provider Scope and Responsibilities](#).

## **.2 THIRD PARTY COMMISSIONING PROVIDER SCOPE AND RESPONSIBILITIES**

- .1 The consultant shall consult local re-zoning and building commissioning by-law requirements, BC Housing and funding partner's commissioning requirements before establishing the commissioning activities and requirements for the project that will be conducted by a 3rd party CxP hired by the Owner/BC Housing. Projects are required to exceed the minimum mandatory commissioning requirements as per re-zoning and municipal by-laws where BC Housing requirements are more stringent. If re-zoning and funding partner's commissioning requirements are not as stringent, then at minimum choose one of the following four options appropriate for the project.
- .2 Depending on the local re-zoning by-laws, project classification and size/complexity of the building, there are four options of implementing the commissioning process in BC Housing projects. These four options described here are for an independent 3<sup>rd</sup> party commissioning hired by the Owner/BC Housing. This should not replace the consultants, contractor, their sub-contractors or their own 3rd party agency's responsibilities as outlined in [Article 2.1 - Consultant and Contractor Commissioning Responsibilities](#).
- .3 The project team is responsible to choose one of the four options based upon the project complexity. The options are as follows:
  - .1 **Option 1** - Independent Enhanced Commissioning, if required by re-zoning or funding partners (hired by Owner)

- .2 **Option 2** - Independent Commissioning, 7-storey or higher or high complexity project (hired by Owner)
  - .3 **Option 3** - Independent Mechanical Commissioning, 3-6 storey or medium complexity project (hired by Owner)
  - .4 **Option 4** - Independent Mechanical Commissioning, 1-2 storey or low complexity project (hired by Mechanical Contractor)
- .4 Option 1 - Independent Enhanced Commissioning, if required by re-zoning or funding partners (hired by Owner)**
- .1 Where the project is required to achieve 3rd party certification or where Enhanced Commissioning (as outlined in Leadership in Energy and Environmental Design, LEED v4) is required by the local re-zoning by-laws or by funding partners, the commissioning process shall follow the requirements of Enhanced System Commissioning or any other requirements by the municipality that is more stringent than BC Housing requirements depending on building type (the options outlined above).
  - .2 Before the Design Development phase is complete or per rezoning, the Owner shall retain the CxP who will review the design requirements/concepts and oversee/implement the Enhanced Commissioning process of the mechanical, electrical and building envelope components (if required) as related to functionality, energy performance and durability.
  - .3 The commissioning process and activities will depend as indicated by the rezoning or funding partner's requirements and may follow the latest version of ASHRAE Guideline 0- "The Commissioning Process", ASHRAE Guideline 1.1 "HVAC&R Technical Requirements for The Commissioning Process", or an alternate commissioning standards such as ASHRAE Standard 202 "The Commissioning Process for Buildings and Systems", CSA Z320 "Building Commissioning Standard, CSA Z8001 "Commissioning Standard of Health Care Facilities, or the upcoming CSA Z5000 "Building Commissioning For Energy Using Systems."
  - .4 The required commissioning activities and the systems to be commissioned will depend on the local re-zoning by-laws requirements.

**Systems to be commissioned:**

- .1 Per rezoning or funding partner's requirements, but at a minimum meet BC Housing commissioning scope based on the options as indicated above depending on the building type.
  - .2 The CxP will be required to participate in CAN/ULC S1001 Integrated Systems Testing of Fire Protection and Life Safety Systems. Integrated Systems Testing is to be performed and documented by the general contractor and coordinated and reviewed by the architect.
- .5 Option 2 - Independent Commissioning, 7-storey or higher or High Complexity Project (hired by Owner)**
- .1 For projects where there is no rezoning or funding partner's commissioning requirement, if the building is 7 storeys or higher or it is deemed as having increased complexity (such as mixed use, separate mechanical and electrical systems for different user groups, high energy performance buildings with renewable systems, etc.), there shall be an independent CxP hired by the owner.

- .2 The CxP's involvement will begin at the Design Development stage and no later than 50% construction document stage. The scope will be in line with Fundamental Commissioning as (as outlined in Leadership in Energy and Environmental Design, LEED v4), with a few exceptions, notably the systems to be commissioned, and increased involvement in the post-occupancy phase of the project.
- .3 Depending on complexity of the project or if recommended by the consultant, the requirement for an independent CxAg hired by the mechanical contractor can be included in the mechanical specifications for Option 2 to conduct the commissioning process. Prior consultation is required with BC Housing and Owner. Refer to [Article 2.1.1 Consultant and Contractor Commissioning Responsibilities](#) under Mechanical, HVAC, and Plumbing Systems Commissioning.
- .4 The CxP will create the 25% sampling methodology of on-site checks that they will be completing if an independent CxAg hired by the mechanical contractor. Otherwise, the CxP will complete 100% on-site checks. The construction contract documents shall clearly state who will perform the on-site checks.
- .5 The typical commissioning activities involved in this option will include:

<b>REQUIRED COMMISSIONING ACTIVITIES: OPTION 2 Independent Commissioning (hired by Owner)</b>	
1.	Assist Owner to develop Owner's Project Requirements
2.	Review Basis of Design
3.	Develop and implement a Cx plan
4.	Confirm Cx requirements/activities (including system test procedures, contractor's commissioning responsibility, training, etc.) into the construction documents
5.	Perform and document static verification and witness manufacturer's start up, as required
6.	Perform and document functional performance testing
7.	Prepare and update issue logs
8.	Review O&M manual, and summarize equipment warranties and maintenance schedule
9.	Facilitate training to Operator
10.	Provide final Cx report
11.	Provide warranty walkthrough

**Systems to be commissioned:**

- .1 The CxP is to be involved in the commissioning of the following systems in this option:
  - HVAC&R and their tie in to life safety systems
  - Electrical systems as related to life safety that are not part of ULC S537 "Verification of fire alarm systems" (such as smoke control and smoke venting equipment including fan and dampers, hold-open device/electro-magnetic locks, fire-pumps, etc.)
  - Other building elements as related to life safety (i.e. generators, etc.)
  - Domestic water systems

- Building automation systems
  - On-site renewable energy systems (if applicable)
- .2 The CxP will be required to participate in CAN/ULC S1001 Integrated Systems Testing of Fire Protection and Life Safety Systems. Integrated Systems Testing is to be performed and documented by the general contractor and coordinated and reviewed by the architect.

**Commissioning Management:**

- .1 The CxP is to lead the commissioning process, and chair commissioning meetings with the owner, consultant, general contractor and trades. As a guideline at construction stage, it is anticipated that the following would be required during the final 4 to 6 months of construction:

- Meetings every other week for 3-4 months
- Weekly meetings for the final 1-2 months of construction

**.6 Option 3 - Independent Mechanical Commissioning, 3-6 storey or Medium Complexity Project (hired by Owner)**

- .1 For projects where there is no rezoning or funding partner's commissioning requirement, if the building is 3-6 storeys or it is deemed as having reduced complexity, there will be an independent mechanical CxP hired by the owner or BC Housing.
- .2 If more value is found in Option 2 than Option 3, Option 2 can be chosen depending on the complexity of the building subject to the Owner's discretion.
- .3 100% checks of mechanical equipment are to be completed by the Mechanical CxP hired by the Owner, unless there is an independent mechanical commissioning agency under the mechanical contractor's scope as per contract document. Otherwise, CxP will create the 25% sampling methodology of on-site checks that they will be completing.
- .4 The Mechanical CxP's involvement will begin at the construction stage. The CxP will create the Cx Plan outlining the scope of commissioning activities at construction phase, along with responsibilities, schedules and procedures and distribute the plan to Owner and commissioning team before the commissioning process starts at site. The activities are summarized below.

<b>REQUIRED COMMISSIONING ACTIVITIES: OPTION 3 Independent Commissioning (hired by Owner)</b>	
1.	Develop Cx Plan, pre-functional checklists and system test procedures
2.	Perform and document static verification and witness manufacturer's start up, as required
3.	Perform and document functional performance testing
4.	Prepare and update issue logs
5.	Review O&M manual, and summarize equipment warranties and maintenance schedule
6.	Facilitate training to Operator
7.	Provide final Cx report
8.	Provide warranty walkthrough

**Systems to be commissioned:**

- .1 The CxP is to be involved in the commissioning of the following systems:
  - HVAC&R and their tie in to life safety systems
  - Domestic water systems
  - Building automation systems
  - On-site mechanical renewable energy systems (if applicable)
- .2 The CxP will be required to participate in CAN/ULC S1001 Integrated Systems Testing of Fire Protection and Life Safety Systems. Integrated Systems Testing is to be performed and documented by the general contractor and coordinated and reviewed by the architect.

**Commissioning Management:**

- .1 The CxP is to lead the mechanical commissioning process, and chair commissioning meetings with the owner, consultant, general contractor and trades. As a guideline, it is anticipated that the following would be required during the final 4 months of construction:
  - 6 to 8 meetings
- .2 At a minimum the commissioning process shall be divided into five distinct phases (either hired by Owner or mechanical contractor) as follows:

**Phase 1 - Static Verification**

The CxP shall check that specific equipment or system is ready for starting, that all tests and certificates have been completed and all equipment have been verified by the mechanical contractor and is ready to operate, including all wiring and controls. The CxP shall issue pre-functional checklists and commissioning tracking checklists for the team. The Issue logs shall be documented, discussed and monitored throughout Cx process. 100% checks of mechanical equipment are to be completed by the Mechanical CxP hired by the Owner if the contract did not specify an independent mechanical CxAg under the mechanical contractor's scope.

**Phase 2 - Witness Equipment Start Up**

The CxP shall witness start-up and check-out operation, calibration, testing and adjusting of all equipment and systems performed by the contractor or manufacturer and shall certify the operations as complete. This includes all air and water balancing performed by the TAB agency. All deficiencies shall be recorded and reviewed by the commissioning team (that consists mechanical consultant, general contractor, mechanical contractor, contractor's mechanical Cx agency, if any and Owner hired CxP) and shall be corrected and verified prior to proceeding further.

**Phase 3 - Functional Performance Testing**

The CxP shall create the functional testing checklists, perform functional tests, submit all test certificates and the Commissioning Completion Certificate at the time of requesting commencement of the verification process. The CxP shall draw up a schedule for the verification inspection by the consultant. The schedule shall

list all equipment and systems and the estimated time required for verifying the operation of each item. This phase includes reviewing the project record drawings for accuracy and completeness, preparation of reviewing the O&M manuals, equipment warranty and maintenance schedules, and submitting all testing/start-up reports and certificates/approvals from the authorities having jurisdiction. When all required documents and certificates are complete, and all equipment and systems are in full and satisfactory operation, the substantial completion may be declared by the consultant. All this stage, all issues documented in the Issues Log shall be resolved.

#### **Phase 4 - Operation & Maintenance Manual Review, Demonstration, and Training**

The CxP shall review mechanical O&M manuals and prepare a warranty summary list and maintenance schedule for BC Housing. The CxP shall prepare a schedule for the demonstration and instructional process and a training agenda, which shall be coordinated with contractor and reviewed and approved by the consultant and the Owner prior to implementation. The operation and maintenance requirements of all equipment and systems shall be demonstrated and explained in detail to the Owner's operating personnel. The controls contractor shall provide a separate demonstration/ training for controls and sequences of operation. On completion of the demonstration and instructional process, the CxP shall obtain a signed statement of satisfaction from the building Owner and/or their operating personnel.

#### **Phase 5 - Post-Substantial Performance Follow-up and Verification of Systems Operations**

The CxP shall allow for a minimum of two separate site visits, scheduled for approximately five months and 10 months after the date of substantial completion, for general trouble-shooting, seasonal testing (if scheduled) and verifying the operation and maintenance of all equipment and systems. These site visits are over and above normal trouble-shooting and warranty call-backs that may require CxP's coordinate with the contractor and consultant team to perform. Following each site inspection, the CxP shall submit a detailed report to the consultant and the Owner outlining his findings, any problems encountered with the operation and maintenance of equipment and systems and any required repair work or correctional action. When all issues are resolved, the CxP shall prepare the final Cx report to the Owner and Cx team.

### **.7 Option 4 - Mechanical Commissioning, 1-2 storey or Low Complexity Project (by independent mechanical commissioning hired by Mechanical Contractor)**

- .1** For projects where there is no rezoning or funding partner's commissioning requirement, if the building is 1-2 storeys and it is deemed as having reduced complexity, there will be a requirement for the mechanical contractor to hire an independent mechanical commissioning agency. These requirements need to be clearly outlined in the drawings and specifications prepared by the mechanical consultant.
- .2** The commissioning process shall start at the construction stage. Note that a testing and balancing report does not satisfy the scope of the mechanical commissioning agency; while it can be the same agency performing the work, there needs to be a separate mechanical commissioning report at the end of Cx process.

- .3 The requirements for the contractor-hired mechanical CxP is to be included in the mechanical specifications.
- .4 The typical commissioning activities involved in this option will include:

<b>REQUIRED COMMISSIONING ACTIVITIES: OPTION 4 Independent Mechanical Commissioning (Hired By Mechanical Contractor)</b>	
1.	Perform and document static verification and start up
2.	Perform and document functional performance testing
3.	Review O&M documentation
4.	Provide training to Operator
5.	Provide Final Cx report

**Systems to be commissioned:**

- .1 The CxAg hired by the mechanical contractor is to be involved in the commissioning of the following systems:
  - HVAC&R and their tie in to life safety systems
  - Domestic water systems
  - Building automation systems
  - On-site mechanical renewable energy systems (if applicable)
- .2 In coordination with the project architect, the general contractor will be required to perform in CAN/ULC S1001 Integrated Systems Testing of Fire Protection and Life Safety Systems and document in a report. The report shall be submitted at the substantial completion.

### **.3 BUILDING COMMISSIONING IN RENEWALS AND CAPITAL PLANNING PROJECTS**

- .1 Depending on the building size, project scope, and complexity of the renewal and capital planning projects, the project team should choose a commissioning approach as described in the preceding sections.
- .2 The systems to be commissioned will depend on the scope of the project and how the other building systems are integrated with the upgrade. For an example, an HVAC upgrade will require not only the commissioning of the HVAC and control systems but also their tie in to life safety systems.
- .3 The CxP hired by the Owner/BC Housing will be required to participate in CAN/ULC S1001 Integrated Systems Testing of Fire Protection and Life Safety Systems. Integrated Systems Testing is to be performed and documented by the general contractor and coordinated and reviewed by the consultant involved in the project.

End of Section

# 02 30 00 - Subsurface Investigation

## 1 General

### .1 SITE INVESTIGATION REPORT: FOR ALL CONTRACTS EXCEPT DESIGN BUILD (DEVELOPER PROCURED LAND)

- .1 The Owner will appoint and pay for a geotechnical investigation report for the project site.
- .2 The investigation report is to identify subsurface (i.e. soil and groundwater) conditions and provide recommendations for site preparation including anticipated stripping depths, temporary excavation slopes, active soil level, foundation design, excavation, dewatering, pavement design, backfill material specifications, compaction requirements including the suitability of the site soils for re-use as structural fill, seismic, seepage and drainage considerations. The report should consider the seasonal variations of the soil, particularly in the interior and northern region where freezing depth can have additional effects on construction.  
Recommendations for pavement design shall consider loading from fire trucks, garbage trucks, and other heavy vehicular traffic.  
*Ensure that adequate boreholes are provided for the development site including the building location, parking areas and pavements.*
- .3 The report shall contain the recommendations for lateral earth pressures on below-grade foundation walls, for construction of interior slabs-on-grade, perimeter foundation, underslab drainage and estimates of potential total and differential post-construction foundation settlement.
- .4 The report will be obtained for the Owner's use in design. The report and borehole and/or test pit logs or other subsurface data will be made available for the contractor's information as an appendix to the bid documents.
- .5 The report by its nature cannot reveal all conditions that exist or can occur on the site and the contractor is assumed to be knowledgeable of the limitations of such reports. The report is provided for information only and no guarantee is made of the subsurface conditions other than at the exact borehole locations and to the depth of investigation at those locations.
- .6 The Contractor is required to visit the site and acquaint themselves with all existing conditions as well as the geotechnical report, included in the contract documents. Also refer to applicable BC Housing supplementary general conditions for the project to warrant Contractor's responsibility.

### .2 SITE INVESTIGATION REPORT: FOR DESIGN BUILD (DEVELOPER PROCURED LAND)

- .1 The Developer must appoint and pay for a geotechnical investigation report on the project site to identify subsurface conditions. Provision should be made by the Developer/Builder for site reviews, inspections and testing including reporting during site preparation, foundation, excavation and pavement construction.

- .2 The investigation report shall provide the recommendations as specified in the clauses 1.2 and 1.3 above.
- .3 Submit one (1) hardcopy and one (1) electronic copy of the geotechnical investigation report(s) to BC Housing.
- .4 Submit progress and final reports from the Geotechnical Consultant for all field reviews, inspection and testing carried out during construction including excavation/backfill placement/backfill compaction and pavement construction, including base, sub-base and asphalt compaction.

End of Section

# 03 30 00 - Cast in Place Concrete

## 1 General

- .1 Architectural and/or structural concrete specifications shall be prepared by the architect and/or structural engineer.
- .2 All concrete construction must conform to CAN/CSA A23.1/A23.2 Concrete Materials and Methods of Construction/Methods of Test for Concrete.
- .3 The Contractor must appoint and pay for a CSA certified inspection agency to review concrete mix designs and perform concrete testing in accordance with CAN/CSA A23.1. Submit copies of mix designs and test reports to the Consultant and BC Housing.
- .4 The use of supplementary cementing materials (SCMs) conforming to CSA A3000 can be considered to increase the recycled content of concrete.
- .5 The use of regionally available concrete materials is recommended.
- .6 Consideration should be given to the reduction in the amount of heat-absorptive, impervious paved surfaces that may contribute to the heat island effect.

## 2 Products

### .1 CONCRETE TOPPING

Provide a 38 mm (1 - 1/2") concrete floor topping over all wood sub-floors separating residential units.

- .1 Design concrete mix to produce 25 MPa minimum compressive strength at 28 days.
- .2 Course aggregate and slump to CSA A23.1 Chemical admixture to confirm ASTM C494 – water additive will not be accepted.
- .3 Reinforcement: use of Polypropylene fibres or micro fibres to reduce cracking. Use fibre additive only with approval of BC Housing. It is generally recommended to reduce shrinkage and hold thin set concrete together as it will crack at a microscopic level if not used.
- .4 Bond Breaker: 6 mil polyethylene or water based chemical bond breaker as recommended by topping manufacturer must meet ULC requirements for inclusion in a rated assembly and subject to approval of structural engineer.
- .5 Provide a double bottom plate in wood frame construction for wood baseboard backing.

### .2 GYPSUM CONCRETE

- .1 Installation, minimum requirements and gypsum concrete properties to follow ASTM F2419 and the Tests in accordance with modified ASTM C 472. Flame, fuel contributed and smoke

developed – all 'O' and floor assembly must meet ULC and STC rating.

- .2 Provide manufacturer's 5-year warranty on material.
- .3 Applicator to be authorized by the manufacturer and using manufacturer approved mixing and pumping equipment.
- .4 If in-floor radiant heating is provided for the project then:
  - .1 apply in two lifts. A single pour is acceptable if recommended by the manufacturer and providing there is sufficient flow over and under the piping.
  - .2 minimum 19mm (3/4") coverage over piping
  - .3 no potable water piping allowed in topping to prevent heating of potable water and cross over of piping
- .5 Provide a double bottom plate in wood frame construction for wood baseboard backing.
- .6 Gypsum underlayment may be poured over expanded or extruded polystyrene (EPS) board which meets or exceeds the physical properties of ASTM C-578 for Type IV or Type IX or acoustic sound control mats.
- .7 EPS board must be securely fastened to the sub-floor by an adhesive compatible to the EPS board, gypsum slurry or mechanical fastening. Follow manufacturer's recommendations for installing acoustic sound control mats (by licensed applicators).
- .8 Do not use a bond breaker with lightweight concrete. Apply manufacturer's recommended floor primer to the sub-floor or on EPS board or acoustic mat prior to installing gypsum underlayment and applying manufacturer recommended sealer over the underlayment.

The architect shall review compatibility with floor finish materials including specification of moisture content requirements. Refer to [Division 09 65 00 - Resilient Flooring](#).

### **.3 CONCRETE FORMWORK**

- .1 Conform to CAN/CSA – S269.3 Standard Concrete Formwork.
- .2 Formwork for concrete exposed to view: G1S Douglas Fir, Spruce plywood, medium density overlaid plywood or Insulated Concrete Forms (ICF).
- .3 Insulated Concrete Forms (ICF) units manufactured of polystyrene foam plastic insulation conforms to CAN/ULC – S701 for type 2, 3 or 4 polystyrene with minimum insulation R-24.
- .4 ICF installer must be certified/approved by the manufacturer. The use of ICF to be approved by architect/structural engineer at design development stage.

# 3 Execution

## .1 MISCELLANEOUS

- .1 Repair defective concrete as directed by the Consultant. Defective concrete includes honeycombing, rock pockets, chips, spalls and rust stains in exposed concrete surfaces. Establish the materials and methods for repair of defective concrete with the Consultant prior to executing the work. The repair must proceed as soon as possible after removal of forms. As a minimum, defective concrete must be repaired with a sack rub finish or sandblasting as applicable.
- .2 Steel trowel concrete slabs to be left exposed or to receive carpeting, resilient flooring, and sheet membrane waterproofing. Finish floors flat, free from defects which would telegraph through finish material. Conform to CAN/CSA A23.1 for floor finish, flatness ratio, curing and tolerances. Notwithstanding the requirements in CAN/CSA A23.1, slab and floor finishing should meet the tolerances required by the National Floor Covering Association of Canada (NFCA). The use of a self-leveling underlayment will be required where the tolerances cannot be achieved.
- .3 Provide concrete topping control joints in logical areas based on room sizes. Control joints to also be placed at entry to each suite and at other such areas as necessary to control shrinkage cracking.
- .4 When using gypsum concrete topping, installation may take place before or after drywall installation has taken place. Spread and screed gypsum concrete to a smooth surface. Place topping in continuous operation. Provide continuous ventilation and adequate heat during drying. Perform dryness testing after 5 – 7 days. The architect shall review the test result and recommend approval or any further retesting /actions if warranted.

## .2 CONCRETE SIDEWALKS

- .1 Concrete sidewalks and paving to be constructed, reinforced and finished to suit municipal bylaws, BC Ministry of Transportation (MOT) Standard and engineering standards.
- .2 Standard grey sand and cement concrete paving to the exterior areas conforming to applicable exposure class C2 of the CAN/CSA A23.1.
- .3 Slope paving to drain minimum 2%. Provide expansion and contraction joints to suit and at junction of paving and building. Expansion joints are to be at maximum 4.57 m (15') on center. Apply consistent broom finish to sidewalks and paving areas; all paving with broom finish to have tooled joints.
- .4 Concrete paving or sidewalks installed directly on top of base structure, shall be 75 mm (3") thick minimum, reinforced with 152 mm x 152 mm (6" x 6") – 4/4 welded wire mesh or 10M at 457 mm (18") o/c each way, adequately chaired to mid depth.
- .5 Concrete paving or sidewalks installed on 150 mm (6") minimum gravel or sand base, shall be 100 mm (4") thick minimum, reinforced with 152 mm x 152 mm (6" x 6") – 2/2 welded wire mesh or 10M at 457 mm (18") o/c each way, adequately chaired to mid depth.

End of Section

## 04 20 00 - Masonry

### 1 General

- .1 Conduct a pre-construction meeting with masonry contractor and consultant to review specifications, submittals and construction issues.
- .2 Prepare a site mock-up showing the use of units, jointing and coursing, flashing and connectors. Mortar and caulking colour for review by design consultant, owner and BC Housing representative.
- .3 Masonry work shall not proceed until mock-up and submittals have been approved by the design consultants.
- .4 Submit shop drawings for masonry connector design prepared by a structural engineer retained by the Contractor. Sample for metal flashing to be approved by Consultant.
- .5 Installers shall be members in good standing of Masonry Institute of BC, and be qualified under the current Technical Masonry Certification (TMC) program.
- .6 Installation to CSA A371 "Masonry Construction for Buildings". Consultants shall refer to the Guide Specification in the Masonry Institute of BC Technical Manual and incorporate relevant material.
- .7 Consider using materials that are sourced locally and have high recycled content.

### 2 Products

- .1 **Brick Veneer:** To CSA A82, Grade EG, Type S.
- .2 **Concrete Block:** To CSA A165.1, Classification: H/15/A/M.
- .3 **Connectors:** Provide corrosion protected material; stainless steel brick ties to CSA A370 and CSA S304.1 are required. Alternates to this requires BC Housing's approval.
- .4 **Thru-wall Membrane Flashing:** EPDM or SBS modified bitumen peel and stick, minimum 1 mm (0.040"). Primers and mastics as recommended by the membrane manufacturer.
- .5 **Metal Flashing:** Minimum 26 gauge, galvanized to ASTM A653/A 653M, Z275 coating prefinished with Stelcolour 8000 series.
- .6 **Mortar and Grout Mixes:** To CSA A179, Type S mortar and Block-fill grout.

### 3 Execution

- .1** The consultant must give careful consideration to the type of material, the wall system and the structural frame before selecting the movement joint spacing to prevent the deflection of the structural from placing stress on a masonry wall or panel below.  
Movement joints should be left clear of mortar, and properly sealed with caulking over a backer rod.
- .2** Connectors/Corrosion resistant metals fastened to wall studs, space not more than 16" (405 mm) horizontally and 24" (610 mm) vertically.
- .3** Install membrane flashing at base of cavity walls and where cavity is interrupted by horizontal members or supports. Turn flashing up the backup wall a minimum of 203 mm (8"). Form flashing "end dams" where flashing is terminated. Install vertical flashing where outer veneer returns at window or door jambs, to prevent contact of veneer with inner wall. Install metal flashing with a hemmed drip edge in horizontal joints and shelf angles to extend sufficiently beyond the outer face of the wall to prevent staining from drainage. Membrane over the metal flashing must lap within mortar joint.
- .4** Omit mortar from head joints above horizontal flashings to provide weep holes spaced at 610 mm (24") on centre. Provide top vents in masonry as specified, or detailed. Do not block weep holes with sealant or mortar droppings.

End of Section

# 05 50 00 - Metal Fabrications

## 1 General

- .1 Retain a structural engineer registered in the Province of British Columbia to prepare signed and sealed shop drawings and Letters of Assurance for guardrails, handrails and other miscellaneous metal fabrication.
- .2 Consider using materials that are sourced locally and have high recycled content.
- .3 Design handrails and guardrails and connections to withstand lateral forces in accordance with BCBC, municipal bylaws and ASTM E985.
- .4 All connections and attachments to building surfaces must conform to building envelope detailing requirements in order to prevent water ingress.
- .5 Coordinate with work of [Division 09 91 00 - Painting](#) to ensure compatibility of finish systems.
- .6 Metal fabricators shall have a minimum five year's documented experience with fabrication work specified in this section.
- .7 Stone, ceramic, powder-coated metals, plated or anodized metal, glass, concrete, clay brick and unfinished or untreated solid wood flooring must not include integral organic-based surface coatings, binders or sealants.

## 2 Products

- .1 **Exterior Guardrails/Handrails:** Aluminum or steel, powder coat finish. Powder coating to AAMA 2604/2605.
- .2 **Interior Guardrails/Handrails:** Aluminum or steel, powder coat finish. Powder coating to AAMA 2604/2605.
- .3 **Metal Flashings:** Minimum 24 gauge, galvanized to ASTM A653/A 653M-09, Z275 coating prefinished with Stelcolour 8000 series or equal.
- .4 **Exterior Roof Ladder:** to ANSI A14.3 galvanized steel ladder, mounting brackets and connections. Fabricate ladder in accordance with WorkSafe BC requirements.
- .5 **Anchor bolts/Nuts/Washers:** Zinc-coated fasteners for exterior use or where built into exterior walls but are also interior side of moisture barrier. For concrete inserts, use hot-dip galvanized, threaded or wedge type. Nuts, bolts and washers are to be hot dip galvanized in conformance with ASTM A153. Anchor bolts shall be in accordance with ASTM A36/A36M or A307.
- .6 **Bike Rack** (if required): hot-dip galvanized or stainless steel to ASTM A53/A500, powder coat finish with baked enamel top coat for durability.

## 3 Execution

- .1 Anchoring system for handrails to be vertically mounted aluminum base plates, with stainless steel anchor bolts and neoprene gaskets.
- .2 All bolt holes and penetrations through fascia and/or walls shall be injected with sealant to prevent water penetration.
- .3 Metal flashing should be provided with watertight expansion joints on long runs to prevent deformation of the metal sheets.

End of Section

# 06 10 00 - Rough Carpentry

## 1 General

- .1** As shown on structural drawings, lumber grades shall be according to NLGA Standard Grading Rules for Canadian Lumber, maximum moisture content 19%.
- .2** Composite Wood to comply with California Air Resources Board (CARB) ultra-low-emitting formaldehyde (ULEF) resins or no added formaldehyde resins. Composite wood cannot exceed 0.05 ppm of formaldehyde as tested under EN-717-1:2004, ISO 16000-3:2010, ISO 16000-6: 2011, ISO 16000-9:2006, ISO 16000-11:2006 or CEN/TS 16516: 2013.
- .3** Where possible, wood products are recommended to be certified according to the requirements of one of the four internationally recognized third-party audited certification systems: Forest Stewardship Council (FSC), CAN/CSA Z809, Sustainable Forestry Initiative (SFI) (SFI 2010-2014), Program for Endorsement of Forest Certification Systems (PEFC) or other product programs mutually recognized by PEFC.
- .4** Submit to the consultant the wood treatment data for each type of preservative treated wood and fire retardant treated wood products.
- .5** Paints, coatings, adhesives and sealants must not contain methylene chloride and perchloroethylene. Paints and coatings must meet Canadian Volatile Organic Compound (VOC) Concentration Limits for Architectural Coatings Regulations (SOR/2009-264). Adhesives and sealants must meet SCAQMD Rule 1168, effective July 1, 2005.
- .6** Consider using materials that are sourced locally and have high recycled content.

## 2 Products

### .1 LUMBER: Softwood lumber should confirm to CSA O141.

ITEM	MATERIAL/GRADE	DESCRIPTION
Exterior Fascia and Trim	SPF # 2	Textured combed finish, pre-primed for solid colour stain, not less than 51 mm (2") nominal thickness
Fencing	Cedar or Hem Fir treated posts	Stained, galvanized steel, open bottom fence post brackets with 203mm-305mm (8"-12") interface with wood posts to minimize deterioration due to moisture.
Grab bar and Railing blocking	Hem Fir	2" X 12"
Landscaping Timbers	SPF # 2	Pressure treated, rough
Interior/Exterior Wall Backing/Blocking	Hem Fir, SPF # 2	
Cavity Furring/ Strapping	Pressure treated Hem-Fir	

### .2 PLYWOOD: Plywood shall confirm to CSA O121 Douglas Fir Plywood (DFP), CSA O151 Canadian Softwood Plywood (CSP). Panels shall be of an exterior type.

ITEM	MATERIAL/GRADE	DESCRIPTION
Exterior Deck Sheathing	Select Tight Face Grade DFP/ CSP	T & G, plywood under PVC deck waterproofing
Exterior Wall Sheathing	DFP/CSP, sheathing grade or wide end	Confirmation regarding nailing pattern required prior to covering sheathing (see Execution 3.0)
Interior Floor Sheathing	DFS/CSP, sheathing grade	T & G panels, glue and screw fastening.
Interior Floor Underlayment	GIS or Custom Grade DFP/CSP intended for underlayment; 3 ply 9.5 mm (3/8") thick.	Panel type shall comply with requirements for warranty by resilient flooring manufacturer.
Roof Sheathing	DFP/CSP, sheathing grade	Edge support, when required using T & G panels or H clip
Stair	DFS/CSP, sheathing grade	Minimum 25 mm (1") thick
Wall Backing/Blocking	DFP/CSP, sheathing grade	Provide backing for washroom accessories, fixtures and fittings not supplied by backing attachments, mounting and anchoring cabinets, grab bars, mechanical and electrical equipment, and hardware, handrail, and other items attached to stud walls.
Cavity Furring /Strapping	Pressure treated plywood - conforming to CAN/CSA O80 Series	
Exterior Heavy Timber Construction, Landscape	Hem Fir/Douglas Fir	No 2 preservative treated

**.3 ACCESSORIES**

ITEM	MATERIAL/GRADE	DESCRIPTION
<b>Fasteners/Hardware</b>	Confirm to CSA B111 and ASTM A153	Hot dip galvanized in exterior locations, stainless steel for pressure treated wood or high humid areas in treated lumber and elsewhere liable to exposed to corrosion
<b>Insect screen</b>	Black fibreglass	1/16" mesh
<b>Sill Gaskets</b>	Polyethylene	closed cell
<b>Wire Mesh to Storage Lockers</b>	Galvanized	76 mm x 76 mm (3" x 3") 10 gauge welded wire mesh

**.4 WOOD PRESERVATIVES**

- .1** Exterior wood in contact with ground, concrete, masonry, or where continuous moisture may occur, (e.g. roof up stands in flat roofs, planters, heavy timber construction, fence posts) or above ground (e.g. decking): Pressure treatment according to CSA O80 Series, water borne Alkaline Copper Quaternary (ACQ) or Copper Azole (CA) preservative.
- .2** Pressure preservative treatment with Borates may be used as an alternative for lumber & timbers used out of ground contact and continuously protected from liquid water, pressure treatment according to CSA O80 Series. Materials should mark the marking program according to Wood Preservation Canada. Bottom plate of frame walls with sill gaskets does not require pressure treating.
- .3** Use incised lumber for treatment as required by CSA O80 Series.
- .4** Treat cut surfaces with two brush coats of copper naphthenate preservative or liquid Borate as applicable.
- .5** 5 Treat all plywood rainscreen cavity furring/strapping in accordance with CSA- O80.9M for plywood.
- .6** Use hot-dipped galvanized fasteners meeting ASTM A153 and connectors meeting ASTM A653 Class G185 for ACQ and CA pressure treated wood.

## 3 Execution

- .1** All grab bars as per layout specified in Design Consultant's detail drawings. Design Consultant to refer to CAN/CSA B651 - Accessible Design for the Built Environment and BC Building Code, amended section 3.8 for the requirements of grab bar installation. Washroom wall reinforcements should be reinforced with 2" x 12" solid lumber (as noted in the table above) in all bathroom tub, shower, and toilet locations, between the studs and should be centered 915 mm (36") from the top of the finished floor.
- .2** Set exterior wall sill plates and bottom plates in contact with concrete or masonry on full width strip of polyethylene sill gasket.
- .3** Prior to covering exterior sheathing or shear walls, request structural engineer to inspect nailing patterns. Provide confirmation report to BC Housing Inspector.

- .4 Install fascias and trims in longest practical lengths, end joints to be cut at 45 degrees and lapped. Fasten with hot dipped galvanized casing nails and countersink.
- .5 Where fibre-cement siding use prefabricated trims at inside/ outside corners and other trim locations. Provide blocking at trim such that trim overlaps siding.
- .6 Provide insulation, vapor barrier and moisture barriers to walls, soffits and ceiling areas that will become inaccessible to other trades.
- .7 All nails and staples to be long enough so that at least half their length penetrates into the second member. All drilling of holes in roof, floor, ceiling framing members and wall studs to be pre-approved by structural engineer.
- .8 Framing shall provide for possible future shrinkage at interface of concrete, masonry walls, or any other dissimilar materials.
- .9 For Townhouses and 2 storey row houses, at the top of all stairs, install 2" x 12" solid lumber at 900 mm (36") to center from finish floor height. This will allow installing a solid gate at the top of the stairs in future as protection from falling.
- .10 Coordinate with work of [Division 09 91 00 - Painting](#) to ensure compatibility of finish systems.

End of Section

# 06 20 00 - Finish Carpentry

## 1 General

- .1 Workmanship must conform to Part 6 of the Quality Standards for Architectural Woodwork as published by Architectural Woodwork Manufacturers Association of Canada (AWMAC), latest edition.
- .2 Composite Wood to comply with California Air Resources Board (CARB) ultra-low-emitting formaldehyde (ULEF) resins or no added formaldehyde resins. Composite wood cannot exceed 0.05 ppm of formaldehyde as tested under EN-717-1:2004, ISO 16000-3:2010, ISO 16000-6: 2011, ISO 16000-9:2006, ISO 16000-11:2006 or CEN/TS 16516: 2013.
- .3 Lumber grade shall be according to NLGA Standard Grading Rules for Canadian Lumber.
- .4 Where possible, wood products are recommended to be certified according to the requirements of one of the four internationally recognized third-party audited certification systems: Forest Stewardship Council (FSC), CAN/CSA Z809, Sustainable Forestry Initiative (SFI) (SFI 2010-2014), Program for Endorsement of Forest Certification Systems (PEFC) or other product programs mutually recognized by PEFC.
- .5 Paints, coatings, adhesives and sealants must not contain methylene chloride and perchloroethylene. Paints and coatings must meet Canadian Volatile Organic Compound (VOC) Concentration Limits for Architectural Coatings Regulations (SOR/2009-264). Adhesives and sealants must meet SCAQMD Rule 1168, effective July 1, 2005.
- .6 Consider using materials that are sourced locally and have high recycled content.

## 2 Products

ITEM	MATERIAL/GRADE	DESCRIPTION
<b>Baseboards for Carpet/Resilient Flooring</b>	Hemlock or Pine	Primed, 17mm (0.67") thick with profile to top edge. Provide the baseboard height 89 mm (3.5") for tenant suites, 140 mm (5.5") for lobby/corridor/ amenity space/office and 64 mm (2 1/2") for service areas.
<b>Door Casings</b>	Hemlock or Pine	Primed, 57 mm wide x 11 mm thick (2 1/2" x 7/16")
<b>Window Sills</b>	Hemlock or Pine	Primed, 32 mm (1 1/4") thick
<b>Shelving</b>	Plastic coated wire shelving	Full width between walls and intermediate supports, one 305 mm (12") deep shelf in each closet, three 406 mm (16") deep shelves in storage areas, four 406 mm (16") shelves in linen closets. Kitchen pass-through surfaces should be protected with plastic laminate.
<b>Cap to Pony Wall/Stairway</b>	Hemlock or Pine	Primed, 19 mm (3/4") thick
<b>Accessories/Hardware</b>	Galvanized to CSA G164 or stainless steel	Compliance with hardware schedule

## 3 Execution

- .1 Provide all anchors, nails and blocking to secure millwork items.
- .2 Set and secure materials and components in place, rigid, plumb and square.
- .3 Coordinate with work of [Division 09 91 00 - Painting](#) to ensure compatibility of finish systems.

End of Section

# 07 05 00 - Thermal Bridging & Airtightness

## 1 General

- .1 Work in this section is to conform to the Provincial Energy Step Code, and as directed by the Architect and /or Building Envelope Consultant.
- .2 Detailing of building envelope components shall minimize thermal bridging. Thermal bridging is caused by highly conductive elements that penetrate the thermal insulation and/or misaligned planes of thermal insulation. These paths allow heat flow to bypass the insulating layer, and reduce the effectiveness of the insulation.

Design Consultants shall refer to the [Building Envelope Thermal Bridging Guide](#) to address problematic energy code compliance details. The guide provides methods and data that building designers can use to determine effective overall U- and R-values for many common enclosure assemblies characterized by significant thermal bridging, including but not limited to the following:

- .1 Exposed Concrete Slab Edges, Shear Walls, Concrete Eyebrows, and Balcony Projections.
  - .2 Window-wall and Curtain Wall Spandrel Sections.
  - .3 Cladding Attachment through Exterior Insulation.
- .3 Detailing of building envelope components shall enhance airtightness and minimize uncontrolled air and moisture exchange between the exterior and interior. Building and Energy Performance values must consider the BC Housing [Energy and Environmental Design](#) section including but not limited to the following:
    - .1 The Energy Targets shall be verified through a mandatory building and energy modelling as described in the Provincial Energy Step Code, performed by an experienced Energy Modeler hired by the Owner/Consultant.
    - .2 Envelope Air Leakage Rate (EALR) and Interior Partitions Leakage Rate (IPLR) shall meet the minimum Performance Targets and shall be confirmed by a mandatory testing performed in accordance with the Provincial Energy Step Code and ASTM E 779 respectively.
  - .4 Design Consultants shall also refer to the HPO [Building Enclosure Design Guide - Wood-Frame Multi-Unit Residential Buildings](#) and [Illustrated Guide - R22+ Effective Walls in Residential Construction in B.C.](#) for wood-frame construction in five and six-storey mid-rise buildings, including recommendations and design guidelines for assemblies, details, components and materials.
  - .5 Required insulation levels of assemblies must be calculated using effective not nominal values. Insulation should be continuous to reduce thermal bridging.

- .6 The windows must be carefully integrated into the entire envelope system. Ensure that the air barrier and insulation continuity is maintained at the window / wall interface.
- .7 As insulation and air barriers must be continuous, careful detail attention during design and construction will be required at all transitions. These include:
  - Basements
  - Headers and Rim Joists
  - Roof to Wall Transitions
  - Interior wall to exterior wall junctions
  - Window and door jambs
  - Penetrations through the envelope (Balconies, decks, ducts, electrical outlets, structural anchors, etc.)
- .8 The architect must work closely with the whole team but especially the mechanical engineer, electrical engineer and envelope consultants to make sure the penetration through the exterior walls are limited and properly sealed.

## .9 SUBMITTALS

- .1 The energy modeling shall be conducted by the Architect or Owner. Submit building energy modelling report, certifying compliance with energy performance requirements to BC Housing.
- .2 Air barrier shall be continuous and the consultant shall identify the air barrier as a single unbroken line illustrated on drawings including interfaces between dissimilar materials and parts.
- .3 The contractor shall submit airtightness testing reports from approved independent testing agencies at substantial completion, certifying compliance with the project specifications as well as building and energy performance requirements of BC Housing.

## .10 QUALITY ASSURANCE

- .1 Energy modelling shall be performed in all type of BC Housing projects and initial results shall be submitted to the Owner and development team during schematic design stage. Any changes as the drawings and specifications progress that may impact energy performance shall require submission of a recalculated energy model at Building Permit stage. Final energy modelling report shall include the actual airtightness testing result. The minimum Performance Targets for all new BC Housing projects vary for Part 3 Projects and Part 9 Projects, based on the climate zone and the required Step Code Level. Refer to the requirements of [Energy and Environmental Design](#) Section.
- .2 Whole building Air leakage testing is to be performed in conformance with the *Provincial Energy Step Code*. Airtightness of suites is to be tested to ASTM E 779 or equivalent standard, with target for an Interior Partitions Air Leakage Rate (IPALR) of 1.2L/s/m<sup>2</sup>@50Pa.
- .3 Unit airtightness testing will be conducted to a minimum of 10% of total suites representing a

variety of unit types. Where re-testing is required, due to failure to meet project requirement ratings, the failed suites are to be retested, and for each failure 2 additional suites will be tested until all testing is positive and to the satisfaction of the Building Enclosure Consultant. Refer to [Appendix B Reducing Air Leakage between suites](#).

- .4 Testing is to be performed by an independent agency approved by the Owner, or by the Building Enclosure / Envelope Consultant if they are qualified to provide this service. All costs for airtightness testing are to be included in the Bid Price.

## 2 Execution

- .1 Coordinate start-up meeting with the Building Enclosure Consultant and the Architect to discuss installation, and review Air/Vapour Barrier lap and sealant details at exterior wall openings.
- .2 Careful inspection of the wall assemblies is required during construction to ensure that the air barrier is continuous and all penetrations are sealed.
- .3 Coordinate start-up meeting with the Air Tightness Consultant to undertake a pre-framing review to ensure adequate measures are taken to ensure the portions of the interior air barrier assembly are installed in order to avoid difficulties or test failures during the eventual air testing process.

End of Section

# 07 10 00 - Dampproofing and Waterproofing

## 1 General

- .1 Installers must be trained by the manufacturer for installation of their products.
- .2 Inspection to be provided by the Building Envelope Consultant.
- .3 Dampproof all concrete foundation walls below grade enclosing non-habitable basements and parkades as determined by the Building Envelope Consultant.
- .4 Waterproof all foundation walls below grade enclosing habitable basements and parkades, storage areas, exterior balconies, service rooms, stairs and all below grade walls where deemed necessary by the Geotechnical Report and the Building Envelope Consultant.
- .5 Waterproof suspended concrete slabs and decks over habitable space and balconies over uninhabited space. Extend membrane continuously under planters and upstands – use of a concrete “pre-curb” is recommended.
- .6 Waterproof membrane assembly shall be designed to prevent penetration of the membrane by root systems at planter areas – a minimum 0.50 mm (20 mil) High Density Polyethylene (HDPE) sheet is recommended or a proprietary root barrier.
- .7 Ensure compatibility of overlapping membranes or coatings.
- .8 Paints, coatings, adhesives and sealants must not contain methylene chloride and perchloroethylene. Paints and coatings must meet Canadian Volatile Organic Compound (VOC) Concentration Limits for Architectural Coatings Regulations (SOR/2009-264). Adhesives and sealants must meet SCAQMD Rule 1168, effective July 1, 2005.
- .9 Consider using materials that are sourced locally and have high recycled content.

## 2 Products

- .1 DAMPPROOFING MATERIALS: EXTERIOR DAMPPROOFING/WATERPROOFING**
  - .1 Emulsified Asphalt Mineral – Colloid Type unfilled, for Dampproofing and Waterproofing and for Roof Coating conforming to CAN/CGSB 37.2-M.
  - .2 Filled, Cutback Asphalt for Dampproofing and waterproofing conforming to CAN/CGSB 37.16-M: for use at temperatures below 4° C (39° F).

## .2 WATERPROOFING MATERIALS FOR FOUNDATION WALLS (WHERE DEEMED NECESSARY BY THE CONSULTANT)

- .1 **Self-Adhesive Membrane:** 1.5 mm (1/16" or 60mils) thick, self-adhering membrane of rubberized asphalt integrally bonded to a high density, cross-laminated, polyethylene sheeting with vapor permeance 2.8 ng/pa.s.m<sup>2</sup> (0.05 perms) to ASTM E96.
- .2 **1 Ply SBS Modified Membrane:** 180 g/m<sup>2</sup> non-woven polyester reinforcing, minimum thickness of 4.0 mm (0.160" or 160mils) polyethylene bottom surface for torch application to substrate, granular top surface is required where membrane terminates above grade level, conforming to CGSB 37–GP–56M.
- .3 **Cold Fluid-Applied:** elastomeric asphalt emulsion waterproofing membrane in compliance with CAN/CGSB 37.2 M or ASTM C836. Apply a full and continuous coat at a rate of minimum 2.0 l/m<sup>2</sup> (5 gal/100ft<sup>2</sup>) to provide a minimum wet thickness of 2.3 mm (0.090" or 90mils) ensure no pinholes or blisters. Allow membrane to fully cure/dry prior to subsequent application coatings. Membrane complies with the VOC limits established by the South Coast Air Quality Management District.

## .3 WATERPROOFING MATERIALS FOR SUSPENDED PARKADE SLABS AND DECKS

The 5 year waterproofing guarantee shall be provided for this section per [Section 14 of the SBS Section](#) of the RCABC Roofing Practices Manual. Leak detection is required for heavier overburdens. Wherever possible, design suspended decks with pavers on pedestals or gravel ballasts to avoid requirement for a leak detection system.

### .1 2 Ply SBS Modified Membrane:

- .1 **Base Sheet:** minimum 95 g/m<sup>2</sup> base sheet for non habitable space and 180g/m<sup>2</sup> for habitable space; reinforced with non-woven fibreglass, polyethylene surface top and bottom with a thickness of minimum 3.0mm (0.12" or 120 mils). Product shall conform to the requirements of CGSB 37–GP–56M.
- .2 **Cap Sheet:** 180 g/m<sup>2</sup> cap sheet reinforced with non-woven polyester reinforcing, minimum thickness of 4.0 mm (0.160" or 160mils) confirming to CGSB 37–GP–56M. Granular surface is required where membrane terminated above grade level.
  - .1 10 year manufacturer's warranty shall be provided for the system.

### .2 Hot Applied Rubberized Asphalt Waterproof Membrane

- .1 Membrane should be accepted by BC Housing and consultant prior to the start of construction. Membrane and applicable components shall conform to CGSB 37.50M & CGSB 37.51M respectively, subject to the following conditions:
  - .1 2 ply fully spun-bonded polyester reinforced assembly
  - .2 10 year manufacturer's warranty shall be provided for the system.

## .4 WATERPROOFING MATERIALS FOR BALCONIES

- .1 **Polyvinyl Chloride (PVC) Waterproofing:** polyester reinforced, for use over non-habitable

spaces only, with minimum thickness of 1.5 mm (0.06" or 60mil), UV resistance, heat-welded seams and perimeter attachment conforming to CAN/CGSB 37.54 with an abrasion resistance of 12.6 at 5000.

- .2 Liquid Urethane Waterproofing:** low VOC content, UV resistant, reinforced, slip resistant pedestrian composite system for use over non-habitable spaces with a combined minimum thickness of 1.5 mm (0.06" or 60mil) confirming to ASTM C957.
  
- .5 CRYSTALLINE WATERPROOFING:** hydrophilic, crystalline waterproofing to the mix design approved by concrete ready-mix supplier for exterior underground and above grade applications in place of or in conjunction with externally applied surface membranes. When used as the only barrier to water penetration utilize crystalline water stop at static slab to wall, slab to slab and wall to wall cold joint locations; and manufactures crystalline grout for pipe penetrations, tie holes and general repair of bug holes and honeycombing.
  
- .6 COMPOSITE DRAINAGE MAT:** High impact, dimpled, polystyrene drainage core and a non-woven, needle punched filter fabric adhered to the outward face of the core, sheet draining 18 gpm/ft<sup>2</sup> to ASTM D4716, suitable for use under soil or pavement as applicable. Install over waterproof membrane to provide protection and drainage when the membrane is installed over suspended slabs and on foundation walls.
  
- .7 PROTECTION BOARD/SEPARATION SHEET**
  - .1** 4 mm (3/16") asphalt glass laminate protection board should be used for torch application.
  - .2** SBS modified bitumen membrane having a minimum thickness of 4.0 mm (3/16" or 160mils), non-woven polyester reinforcement of 180 g/m<sup>2</sup> meeting CGSB-37-GP-56M. Sanded lower surface fully compatible with the primary membrane also can be used as an alternative.

## 3 Execution

- .1** Ensure all substrates are prepared and primed in accordance with manufacturer's printed instructions. Ensure that installation takes place only at required temperatures and weather conditions. Fabric reinforcement into liquid applied membrane must ensure no fish-mouthing or wrinkles.
  
- .2** Membranes installed over parkades must extend a minimum of 203 mm (8") up vertical surfaces, from the finished horizontal surfaces, and extend down the face of foundation walls to cover the cold joint between the slab and foundation wall. Refer to [Division 07 50 00 - Membrane Roofing](#) where membranes are applied under landscaping and unit paving.
  
- .3** Protect completed waterproof membrane installation with protection board.
  
- .4** Protect surface applied crystalline waterproofing against rapid loss of moisture for minimum 3 days by the manufacturer's approved methods. Cure crystalline admixture waterproofing as per proper concrete curing practices to ACI-308.

- .5** For urethane membrane broadcast silica sand immediately into topcoat and back roll according to manufacturer's specification.
- .6** Install dampproofing/waterproofing to CAN/CGSB – 37.3M application of Emulsified Asphalt for Dampproofing & Waterproofing.
- .7** PVC Membranes at balconies should consider the following:
  - .1** Install flashings at junctions of walls and deck and drip flashings at all exterior edges of the deck.
  - .2** All seams to be lapped a minimum of 51 mm (2") and heat welded in place.
  - .3** Lap membrane up adjoining walls a minimum of 152 mm (6") except where door entrances do not allow. At doors lap over door threshold rough opening and up jamb rough opening 152 mm (6"). Caulk all transitions, allow for a double row of caulking between door threshold and membrane (primary and secondary barrier).
  - .4** Membrane to be lapped on to and heat welded to drip edge flashing or provide a finished mechanical fastening bar on the vertical face.
  - .5** Finished decks and walkway traffic coating assemblies are to be sloped away from the building at a minimum 2% grade, smooth, fully adhered, neatly edged, and freely draining.
  - .6** No penetrations shall occur through horizontal surfaces.

End of Section

# 07 21 00 - Thermal Protection (Insulation)

## 1 General

- .1 Minimum thermal insulation in wall, roof, and floor assembly shall comply with ANSI/ASHRAE/IESNA 90.1, current BC Building Code, Authority Having Jurisdiction and Model National Energy Code, to meet BC Housing's building and energy performance targets or municipal energy requirements, whichever is better.
- .2 Apply insulation, bonding adhesive and accessories in accordance with the manufacturer specifications.
- .3 Paints, coatings, adhesives and sealants must not contain methylene chloride and perchloroethylene. Paints and coatings must meet Canadian Volatile Organic Compound (VOC) Concentration Limits for Architectural Coatings Regulations (SOR/2009-264). Adhesives and sealants must meet SCAQMD Rule 1168, effective July 1, 2005.
- .4 Thermal resistance values must consider the energy step code requirements of BC Housing. Refer to [Energy and Environmental Design](#) section.
- .5 Consider using materials that are sourced locally and have high recycled content.

## 2 Products

- .1 **RIGID INSULATION:** Extruded closed cell Polystyrene, CAN/ULC – S701 Type 4 with maximum water absorption of 0.7% in accordance with ASTM D2842 for foundation, roofing or wall. RSI/R value of insulation shall be Long-Term Thermal Resistance (LTTR) as determined by CAN/ULC-S770.
- .2 **THERMAL BATT INSULATION:** mineral/glass fibre friction fit, formaldehyde free, CAN/ULC – S702, Type 1 with high post consumer recycled content, to ASTM E84 (flame spread rating  $\leq 25$  and smoke developed rating  $\leq 50$ ) for exterior walls, floors and ceilings.
- .3 **ACOUSTIC BATT INSULATION:** CAN/ULC – S702, Type 1, to ASTM E90, airborne sounds transmission loss and to ASTM E413, sound transmission class for sound rated partitions and floors.
- .4 **BLOWN-IN INSULATION:** Attics, thickness as required to meet R value after settlement occurs.
- .5 **SPRAYED THERMAL INSULATION (OR SPRAY-ON THERMAL INSULATION):** Noncombustible to CAN/ULC S114, and other to CAN/ULC S102, inorganic, elongated glass fibre type, blended with adhesive or mineral fibre, for use where parkade ceiling has heated space over. Applied and cured insulation to conform to the following minimum requirements:
  - .1 **K Factor:** Minimum 0.26 to ASTM C518.

- .2 **Flame Spread:** 0–5 to ASTM E84.
  - .3 **Fuel Contributed and Smoke Developed:** 0 to ASTM E84.
  - .4 **Colour:** White or off-white.
- .6 SPRAY POLYURETHANE FOAM INSULATION (OR SPRAYED-IN-PLACE POLYURETHANE FOAM INSULATION):** CAN/ULC – S705.1 and CAN/ULC – S705.2, noncombustible to meet CAN/ULC S124, for floor joist header, interior concealed wall and ceiling junctions, parapets and roof curbs for penetrations requiring insulation and air seal or as specified by Consultant. U-value shall be maintained over design service life.
- .7 INSULATION CLIPS:** Use to fastening rigid insulation to wall sheathing and soffits. Impale type, perforated 51 mm x 51 mm (2" x 2") steel, 0.7 mm (0.030") thick, adhesive back, spindle of 2.5 mm (0.098") diameter annealed steel, 25 mm (1") diameter self-locking washers, length to suit insulation thickness.

## 3 Execution

### .1 RIGID INSULATION

- .1 Extend boards a minimum of 600 mm (24") below grade.
- .2 Install perimeter insulation using mechanical fasteners or adhesive. Butt joints tightly, offset horizontal and vertical joints. Use largest possible sheets to reduce number of joints. Do not use chipped or cracked insulation boards.
- .3 Protect insulation from UV degradation and ensure the protection is capable of being exposed without UV and moisture degradation.

### .2 BATT INSULATION – THERMAL

- .1 Install insulation full width and length between studs and framing members to fit snugly without buckling, creasing or crushing.
- .2 In walls, install lower batt first; upper batt installed to butt with the first and any extra length of insulation trimmed at the top.
- .3 Fit insulation tight to electrical boxes, pipes, ducts, around exterior doors & windows and other protrusions. Split insulation around wiring, plumbing or any other mid-wall interruption. Do not stuff insulation into corners or gaps – use rigid, spray or semi-rigid insulation, as appropriate. Exterior and interior corners are to be designed to allow installation of insulation.

### .3 BATT INSULATION – SOUND

- .1 Install acoustic insulation for sound rated partitions. Tightly fit insulation between studs to full height of partitions. Fit insulation tight to penetrations through wallboard.
- .2 Install a layer of RSI 2.45 (R14) batt insulation around and under bathtubs.

#### **.4 SPRAYED THERMAL INSULATION**

- .1** Apply material with specially designed nozzle using pressures recommended by the manufacturer.
- .2** Maintain thermal continuity of insulation on entire area to be insulated to ensure thermal performance is achieved.
- .3** Spray material into all cracks, holes, seams; seal around electrical receptacles, telephone and television jacks, ducts and plumbing.
- .4** Tamp insulation to a uniformly level and smooth surface without unsightly projections and voids.
- .5** Apply a clear overspray sealer to the tamped sprayed insulation surface in accordance with manufacturer's directions.
- .6** Completed installation must produce a uniformly smooth white or off-white surface free of cracks, dusting, flaking, spalling, separation and blistering.

**.5 SPRAY POLYURETHANE FOAM INSULATION:** To be installed by trained and certified installers in accordance with CAN/ULC S705.2 using CCMC certified spray foam with an accredited 3rd party Quality Assurance Program (example: CUFCA). Do not expose to sunlight for prolonged time, follow manufacturer's recommendation and conceal as rapidly as possible.

- .6 ACCESS HATCHES:** Insulate access hatches to the same R value as the assembly in which they occur to maintain continuous thermal protection.
- .7** Do not install insulation or vapour barrier until all exterior wood is tested and confirmed to be less than 19% moisture content.
- .8** Install insulation to maintain continuity of thermal protection to building elements and spaces. Multiple layers of insulation should be used where possible, with joints staggered to reduce thermal bypass at the insulation. Exterior insulation should only be interrupted by necessary service penetrations and structural elements.
- .9** For insulation closely around electrical boxes, plumbing, and heating pipes and ducts, around exterior doors, windows and other protrusions.

End of Section

# 07 31 13 - Asphalt Shingles

## 1 General

- .1 The use of products which are regionally extracted and manufactured and/or containing recycled materials are recommended. If recommended by the Owner/Operator, the use of roofing materials meeting Energy Star requirements for high reflectance and low emissivity can be considered.

### .2 QUALITY ASSURANCE

- .1 Materials and workmanship must conform to the guarantee standards of the Roofing Contractors Association of BC (RCABC) as published in the RCABC Roofing Practices Manual, latest published edition and updates, for qualification for a ten (10) year Guarantee Certificate.
- .2 The roofing installation must be inspected by an independent roofing inspection agency paid for by the Contractor in accordance with the RCABC guarantee program. The Owner shall request RCABC to recommend an inspection agency from their list of approved agencies.
- .3 The roofing manufacturer must warrant in writing to the Owner of the building that The Roof System will remain free of any manufacturing defects resulting in water leakage during the applicable warranty period. The warranty will include for removal and replacement of any defect in The Roof System to a water tight condition, including labour or refund the Owner an amount equal to the costs for labor and materials required to replace the defective materials. The warranty shall be non pro-rated for a period of ten (10) years from the date of substantial completion.

### .3 SUBMITTALS

Provide to the Owner, the “RCABC Roofing System Record” upon completion of the work. Record to include guarantees, copies of inspection reports and roof maintenance guide.

### .4 ROOF GUARANTEE

- .1 Provide standard RCABC Ten (10) year guarantee upon completion of the Work.
- .2 Provide a minimum Thirty (30) years guarantee for the asphalt shingle manufacturer's standard material.
- .3 An alternative to the Ten (10) Year RCABC Guarantee may be accepted subject to BC Housing's approval and the provision of the following documentation. This alternative shall be submitted prior to execution of the construction contract and will be paid for by the Contractor.
  - .1 Inspection by an independent roofing inspector during installation to ensure compliance with RCABC Standards.
  - .2 A two (2) year Maintenance Bond with an option to renew for an additional one (1) year at the expiry of the original two (2) year Surety at the discretion of the owner.
  - .3 Inspection by an independent inspector prior to the end of a two (2) year period along with maintenance inspections for year five (5) and eight (8). The inspector will be appointed by the Owner and the cost will be borne by the Contractor.

- .4 Ten (10) year roofing installer's guarantee.
- .5 A minimum ten (10) year full system material non-pro-rated guarantee from the manufacturer or as specified in the Construction Standards.
- .4 For smaller sized-projects with a contract value less than \$20,000, standard RCABC 10 year warranty or 2 years maintenance bond option (article 1.4.3) is not required. A qualified roof inspector to be contracted to complete inspection during installation and at post construction, if required. The inspector will be appointed by the Owner.

## 2 Products

### .1 ASPHALT SHINGLES

Acceptable materials as listed in the RCABC Roofing Practices Manual. Shingle materials manufactured to CSA A123.5 for fibre glass felt core product. Organic felt products are not acceptable as they are not covered under the Roofing Guaranty Corporation (RGC) program.

### .2 METAL FLASHINGS

- .1 Base and counter flashing metal to be sheet steel, minimum 26 gauge, galvanized to ASTM A653/A653M, Z275 coating, prefinished with Stelcolour 8000 series paint finish or equal.
- .2 Step flashings must be 24 gauge and shall extend a minimum of 125mm (5") up vertical services in accordance with RCABC requirements.

### .3 ACCESSORIES

Install zinc strips to all ridge locations with minimum 51 mm (2") exposed to the weather.

### .4 GUTTERS & DOWNSPOUTS

- .1 Prefinished with 2-coat as per ASTM D-1729, 24 gauge seamless one piece aluminum or pre-finished sheet steel gutters and downpipes. Gutter: 127 mm x 127 mm (5" x 5"), and downpipes are of size 51 mm x 75 mm (2" x 3") or 75 mm (3") diameter. All accessories should be provided by the manufacturers. Colour as selected by consultant and compatible with the shingles.
- .2 Downspouts that terminate at sloped roofs shall have the downspouts continued down and over the roof to drain directly into the eaves trough/gutters.
- .3 Downspouts shall be capped where they enter the storm drain, at grade level, with a metal cap finished to match downspouts. Secure the cap to the drain with sheet metal screws. Where storm drains do not exist, terminate downspouts on a dedicated splash pad.

## 3 Execution

- .1 Provide slope to drains in all gutter applications. Waterproof linings for “hidden” or “inboard” or “built-in” type gutters must be fully adhered 2 ply modified bitumen sheets and must be carried up to the slope to a point that is 200 mm (8") vertical above the outside height of the parapet or an emergency overflow outlet in the gutter. The cap sheet is to provide UV protection and must be installed in all areas exposed to UV. Use self adhering base sheet whenever possible with second UV protective ply fully torched to first ply. Ensure drains discharge into downspouts that are kept above freezing.
- .2 Caulking compounds must not be used as the primary water seal for any roofing application or roofing detail.

End of Section

# 07 46 16 - Metal Siding

## 1 General

- .1 Work in this section is to conform to the BC Building Code, and as directed by the Architect and / or Building Envelope Consultant.
- .2 Exterior siding system to be designed to meet BC Building Code requirements for wind load and wind uplift. Indicate test data supporting the above requirements on shop drawing submission.
- .3 Contractor to supply 10% stock for future maintenance purposes.
- .4 Paints, coatings, adhesives and sealants must not contain methylene chloride and perchloroethylene. Paints and coatings must meet Canadian Volatile Organic Compound (VOC) Concentration Limits for Architectural Coatings Regulations (SOR/2009-264). Adhesives and sealants must meet SCAQMD Rule 1168, effective July 1, 2005.
- .5 SUBMITTALS**
  - .1 Submit shop drawings of siding installation, material and accessories. Shop drawings shall indicate thickness and dimension of parts; siding profiles; fastening and anchoring methods; trim and closure pieces, metal soffits; detail and location of joints, including joints necessary to accommodate thermal movement.
  - .2 Shop drawings to be complete with seal of a BC Registered Professional Engineer; show all load calculations and conformity to codes and specifications herein. Submit applicable Letters of Assurance.
- .6 QUALITY ASSURANCE**
  - .1 Metal siding products must conform to CAN/CGSB-93 with a minimum manufacturer's warranty of 30 years and a minimum manufacturer's finish warranty of 15 years.
  - .2 Mock-Ups: Prepare siding mock-ups as directed by the Consultant. Mock-ups must incorporate all required finishing accessories and adjacent materials such as windows, doors, trim and strapping.
- .7 DELIVERY, STORAGE AND HANDLING**
  - .1 Stack panel sheets tilted to provide water runoff. Protect materials from damage by weather or workmen.
  - .2 Ensure packaging of prefinished materials permits ventilation. Vent to encourage air movement.
- .8 COORDINATION WITH OTHER TRADES**
  - .1 All penetrations through the siding for the work of other trades must be fitted with a watertight sleeve.

## 2 Products

### .1 MATERIALS

- .1 Exterior Sheet: aluminum sheet to CAN/CGSB-93.1, and approved for residential building applications, plain or patterned surface, with a minimum nominal thickness of 0.48 mm (25 gauge) base metal, factory prefinished (primed and painted) to colour selected by the Architect.
- .2 Exterior Sheet: steel sheet to CAN/CGSB-93.3 and approved for residential building applications, with a minimum nominal thickness of 0.399 mm (28 gauge) base metal including Z275 zinc coating, factory prefinished (primed and painted) to colour selected by the Architect.
- .3 Sealant: Refer to [Division 07 92 00 - Joint Sealants](#).

### .2 METAL SIDING

- .1 Siding to have the minimum nominal thickness per sheet materials indicated above and to BC Building Code requirements.
- .2 Aluminum Siding: to CAN/CGSB-93.2 Type, VU vertical siding unbacked, SF soffit and fascia facings and exposed trim unbacked, Class 1 plain or 2 patterned.
- .3 Steel Siding: to CAN/CGSB-93.4 vertical siding, soffit and fascia facings and exposed trim type, plain or patterned class, with or without backing as directed by the Architect and / or Building Envelope Consultant.
- .4 Siding to be engineered for climate by the manufacturer for the climate zone in which it is to be installed. Provide written documentation from the manufacturer.

### .3 METAL SOFFIT

- .1 Soffit of flat exterior sheet, 'V' crimped for stiffness, perforated with elongated slits and small perforations, complete with insect screen cover at vents, of same material and colour as metal siding.

### .4 ACCESSORIES

- .1 Exposed trim, closures, cap pieces, etc. of same material and colour as siding.

### .5 FASTENINGS

- .1 Fasteners: to CSA-B111 for wood-frame construction or approved type for metal framing in residential building applications. Corrosion resistant, concealed and sized as recommended by the siding manufacturer.
- .2 Exposed fasteners, where required, must match the painted surface in which they occur. For metal framing, provide self-drilling, galvanic-action isolated fasteners, having the recommended length that meet applicable code and manufacture's minimum requirements.

## 3 Execution

- .1 Confirm acceptability of wall sheathing of soundness, measurement and flatness.
- .2 Install siding and accessories to CAN/CGSB-93.5, and in accordance with manufacturer's printed instructions and reviewed shop drawings.
  - .1 Type, size and spacing of fasteners to meet or exceed manufacturer's minimum requirements.
  - .2 Ensure siding is adequately supported in accordance with siding manufacturer's recommendations.
  - .3 Install sill flashings, starter strips, inside corners, edgings, and soffits.
  - .4 Install siding and attachments from sill up, to manufacturer's written instructions.
  - .5 Install trim and siding using longest practical lengths, straight, true to line and level with clean cut edges and joints.
  - .6 Install exterior corners, fillers and closure strips with carefully formed and profiled work. Install with concealed fasteners.
  - .7 Maintain joints in exterior sheets, true to line, tight fitting.
- .3 Do not install siding less than 200 mm (8") from any previous surface of ground or loose fill grade nor closer than 50 mm (2") to roofs, patios, porches, decks and other solid surfaces where water may collect.
- .4 Install sheet metal flashing above door and window casings and horizontal trim in field of siding. Install accessories so that junctions of siding with dissimilar construction will be finished with trim members
- .5 Finished installation must be properly secured, free of rattles, distortions, waviness, protrusions, and damaged or chipped components.
- .6 Caulk joints, seams and junctions with dissimilar materials, with specified sealant. Refer to [Division 07 92 00 - Joint Sealants](#) for caulking technique and workmanship.
- .7 Provide all components including drip and cap flashings, screws and fasteners as required to complete installation.
- .8 Seal around all penetrations and field-prime and paint exposed un-primed or un-painted trim surfaces and cut edges. Refer to [Division 09 91 00 - Painting](#).

End of Section

# 07 46 33 - Vinyl Siding

## 1 General

- .1 Work in this section is to conform to the BC Building Code, and as directed by the Architect and / or Building Envelope Consultant.
- .2 Exterior siding system to be designed to meet BC Building Code requirements for wind load and wind uplift.
- .3 Contractor to supply 10% stock for future maintenance purposes.
- .4 **SUBMITTALS**
  - .1 Submit shop drawings of siding installation, material and accessories. Shop drawings shall indicate thickness and dimension of parts; fastening and anchoring methods; detail and location of joints, including joints necessary to accommodate thermal movement.
  - .2 Shop drawings to be complete with seal of a BC Registered Professional Engineer; show all load calculations and conformity to codes and specifications herein.
- .5 **QUALITY ASSURANCE**
  - .1 Vinyl siding products must conform to ASTM D3679 and with CAN/CGSB 41.33–M87. Colour retention should conform to ASTM D6864. Products should be selected from the Vinyl Siding Institute's (VSI) list of certified products.
  - .2 Prepare siding mockups as directed by the Consultant. Mockups must incorporate starter strips, siding, soffits, all required finishing accessories and adjacent materials such as windows, doors, trim and strapping.
- .6 **COORDINATION WITH OTHER TRADES**

All penetrations through the siding for the work of other trades must be fitted with a watertight sleeve.
- .7 Paints, coatings, adhesives and sealants must not contain methylene chloride and perchloroethylene. Paints and coatings must meet Canadian Volatile Organic Compound (VOC) Concentration Limits for Architectural Coatings Regulations (SOR/2009-264). Adhesives and sealants must meet SCAQMD Rule 1168, effective July 1, 2005.
- .8 Consider using materials that are sourced locally and have high recycled content.

## 2 Products

- .1 **VINYL SIDING:** Integrally coloured rigid polyvinyl chloride (PVC), complying with ASTM D 3679 with minimum nominal thickness 1.1 mm (0.044").

**.2 VINYL SOFFIT:** Integrally coloured rigid polyvinyl chloride (PVC), complying with ASTM D 4477 with minimum nominal thickness 1.1 mm (0.044"), 203 mm (8") wide perforated /non-perforated.

### **.3 ACCESSORIES**

- .1** Starter strips, window under sill trim drip caps, "F" channel, base flashing, inside and outside corner posts and "J" channel shall have the same compound materials with comparable siding properties for a complete and finished installation so that there are no exposed unfinished edges.
- .2** Provide mounting blocks to ensure a watertight and finished installation for handrails, door bells, lights, gas and electrical connections, dryer vents, and other exterior fixtures.

### **.4 FASTENINGS**

Corrosion resistant, concealed and sized as recommended by the siding manufacturer. Exposed fasteners, where required, must match the surface in which they occur. Provide appropriate corrosion resistance fasteners if they penetrate through pressure treated materials.

## 3 Execution

- .1** Install siding and accessories in accordance with manufacturer's printed instructions, reviewed shop drawings and the latest edition of the "Rigid Vinyl Siding Application Manual" published by the Vinyl Siding Institute.
- .2** Provide starter strip at the base of all walls including stepped wall locations.
- .3** Lay out siding lengths to achieve a regular staggered joint pattern. Use longest practical lengths and minimize joints where possible.
- .4** Install siding true to line and level with clean cut edges and joints.
- .5** Nails must penetrate the substrate by a minimum of 25 mm (1").
- .6** Nail only in the centre of the nailing slot. Leave a space of 2 - 3 mm (1/16" – 1/8") between the nail head and the siding surface, do not nail tightly. Pre-punch vinyl surface before nailing.
- .7** Overlap siding and accessories. Cut-outs for overlap should be 38 mm (1-1/2") long and overlap 1/2 of the cut-out width. Do not nail overlapping siding/accessories within 152 mm (6") of the joint.
- .8** Where panels fit into accessories, leave 6 mm (1/4") clearance for expansion.
- .9** Lift panels into the lock when nailing, but not pulled up tight. Panels must hang in the lock without strain.
- .10** Provide watertight fitted PVC penetration fittings.

- .11** Install accessories so that junctions of siding with dissimilar construction will be finished with trim members.
- .12** Use inside and outside corner posts at the junction of internal and external corners and ensure that all siding and accessories are overlapped, except where noted otherwise.
- .13** Trim soffit openings with “F” channel or 9.5 mm (3/8”) aluminum “J” channel.
- .14** Provide “J” channel around the sides of windows and door frames.
- .15** Provide drip cap above all window and door openings and extend on each side with the exposed leg of the siding “J” channel. Bend tab down over “J” channel on the sides and seal watertight.
- .16** Use undersill trim under windows and doors and at the top of walls adjoining soffits.
- .17** Finished installation must be properly secured, free of rattles, distortions, waviness, protrusions, and damaged or chipped components.
- .18** Provide downspouts connected to storm drains.

End of Section

# 07 46 46 – Fiber-Cement Siding

## 1 General

- .1 Work in this section is to conform to the BC Building Code, and as directed by the Architect and Building Envelope Consultant.
- .2 **SUBMITTALS**
  - .1 Submit shop drawings of siding installation, material and accessories. Shop drawings shall indicate thickness and dimension of parts; fastening and anchoring methods; detail and location of joints, including joints necessary to accommodate thermal movement.
  - .2 Shop drawings to be complete with seal of a BC Registered Professional Engineer; show all load calculations and conformity to codes and specifications herein. Submit applicable Letters of Assurance.
- .3 **QUALITY ASSURANCE**
  - .1 Fiber cement siding products must conform to ASTM C1185 and C1186 with a minimum manufacturer's warranty of 30 years and a minimum manufacturer's finish warranty of 15 years.
  - .2 Mock-Ups: Prepare siding mockups as directed by the Consultant. Mockups must incorporate all required finishing accessories, fasteners and adjacent materials such as windows, doors, trim and strapping.
  - .3 Paints, coatings, adhesives and sealants must not contain methylene chloride and perchloroethylene.  
Paints and coatings must meet Canadian Volatile Organic Compound (VOC) Concentration Limits for Architectural Coatings Regulations (SOR/2009-264). Adhesives and sealants must meet SCAQMD Rule 1168, effective July 1, 2005.
  - .4 Consider using materials that are sourced locally and have high recycled content.

## 2 Products

- .1 **Fiber Cement Board:** Cement and cellulose fiber formed under high pressure into boards complying with ASTM C 1186 Type A Grade II machined edges.
- .2 Siding to have the minimum nominal thickness of 8 mm (5/16"), factory sealer/primer and pre-painted with minimum 15-year labour and material warranty on the factory applied coating system. Finish painting by manufacture requirements and [Section 09 91 00 – Painting](#), if required.
- .3 Siding to be engineered for climate by the manufacturer for the climate zone in which it is to be installed. Provide written documentation from the manufacturer.
- .4 **Accessories:**
  - .1 **Fiber Cement Trim:** Minimum thickness 25 mm (1") factory sealer/primer and pre-painted;

colour as selected by Owner or Consultant to match or contrast siding. Wood trim is also an approved alternate. Finish painting by manufacture requirements and [Section 09 91 00 – Painting](#), if required.

- .2 **Break-Formed Trims/Flashings:** 24 gauge minimum base material thickness, aluminum zinc-coated conforming to ASTM A792/A792M, prefinished, factory applied premium coating.
- .3 **Fastenings:** Corrosion resistant, hot-dip galvanized nails to CSA B111, concealed and sized as recommended by the siding manufacturer. Exposed fasteners, where required, must match the painted surface in which they occur. For metal framing, provide self-drilling, corrosion resistant, S-12 ribbed bugle-head having the recommended length that meet applicable code and manufacture's minimum requirements.
- .4 Sealants: In accordance with [Section 07 92 00 – Joint Sealants](#), polyurethane type.

## 3 Execution

- .1 Install fiber-cement siding and accessories in accordance with manufacturer's written instructions. Type, size and spacing of fasteners to meet or exceed manufacturer's minimum requirements.
- .2 Ensure siding is adequately supported in accordance with siding manufacturer's recommendations.
- .3 Install trim and siding using longest practical lengths, straight, true and plumb.
- .4 Use full pieces wherever possible to minimize appearance of seams. Arrange seams in random pattern as per the manufacture's written instructions to minimize appearance and to be away from most prominent line of vision.
- .5 Do not install siding less than 200 mm (8") from any previous surface of ground or loose fill grade nor closer than 50 mm (2") to roofs, patios, porches, decks and other solid surfaces where water may collect.
- .6 Provide minimum 3 mm (1/8") gap where lapped plank or shingle meets the vertical trim at openings and corners to allow for proper flexible sealant/caulking.
- .7 Install sheet metal flashing above door and window casings and horizontal trim in field of siding.
- .8 Seal around all penetrations and field-prime and paint exposed un-primed or un-painted trim surfaces and cut edges. Refer to [Section 09 91 00 – Painting](#).

End of Section

# 07 50 00 - Membrane Roofing

## 1 General

- .1 The use of products which are regionally extracted and manufactured and/or containing recycled materials are recommended. If recommended by the Owner/Operator, the use of roofing materials meeting Energy Star requirements for high reflectance and low emissivity can be considered.

### .2 QUALITY ASSURANCE

- .1 Materials and workmanship must conform to the guarantee standards of the Roofing Contractors Association of BC (RCABC) as published in the RCABC Roofing Practices Manual, latest published edition and updates, for qualification for a ten (10) year Guarantee Certificate.
- .2 The roofing installation must be inspected by an independent roofing inspection agency paid for by the Contractor in accordance with the RCABC guarantee program. The Owner shall request RCABC to recommend an inspection agency from their list of approved agencies.
- .3 The membrane manufacturer must warrant in writing to the Owner that the roof membrane system will remain free of any manufacturing defects resulting in water leakage during the applicable warranty period. The warranty will include for removal and replacement of any defect in the roof membrane system to a water tight condition including labour, or refund the Owner an amount equal to the costs for labor and materials required to replace the defective materials. The warranty shall be non pro-rated for a period of ten (10) years from the date of substantial completion.

### .3 SUBMITTALS

Provide to the Owner, the "RCABC Roofing System Record" upon completion of the work. Record to include guarantee, copies of inspection reports and roof maintenance guide.

### .4 DELIVERY, STORAGE AND HANDLING

- .1 2 ply SBS membrane roofing must comply with or exceed RCABC Safety Precautions – Torching for Modified Bituminous Systems as described in the RCABC Roofing Practices Manual ([Refer to SBS section - Application Guides & Notes](#)). Failure to do so may result in the work being suspended by the Consultant or Inspection Agency for non compliance with this requirement.
- .2 For all membranes, insure that materials are clearly labeled and seals intact.
- .3 Store all materials in accordance with the manufacturer's specifications.

### .5 REGULATORY REQUIREMENTS

Roof Covering Materials: Tested in accordance with CAN/ULC S107M to achieve a Class A rating for exposed membrane systems and Class A, B or C for any other areas as required by local authorities having jurisdiction.

## .6 ROOF GUARANTEE

- .1 Provide standard RCABC ten (10) year guarantee upon completion of the Work.
- .2 The following is an alternative to the Ten (10) Year RCABC Guarantee may be accepted subject to BC Housing's approval and the provision of the following documentation. This alternative shall be submitted prior to execution of the construction contract and will be paid for by the Contractor.
  - .1 Inspection by an independent roofing inspector during installation to ensure compliance with RCABC Standards.
  - .2 A two (2) year Maintenance Bond with an option to renew for an additional one (1) year at the expiry of the original two (2) year Surety at the discretion of the owner.
  - .3 Inspection by an independent inspector prior to the end of a two (2) year period along with maintenance inspections for year five (5) and eight (8). The inspector will be appointed by the Owner and the cost will be borne by the Contractor.
  - .4 Ten (10) year roofing installer guarantee.
  - .5 A minimum ten (10) year full system material non-pro-rated guarantee from the manufacturer or as specified in the Construction Standards.
- .3 Note RCABC guarantee will apply to roofing membrane under soft landscape area, unit paver areas and under paving slabs. RCABC will also guarantee the membrane under poured in place concrete provided that a leak detection grid is installed (refer to [section 14 of the SBS section](#) of the RCABC Roofing Practices Manual). RCABC guarantee only covers the membrane (roofing) repair/replacement and only when the correct protection sheets are used in conjunction with the membrane system. It also applies to removal and replacement of landscape or paver overburden if it is less than **152mm (6")** deep and installed by the roofing contractor. The minimum membrane thickness of the modified bitumen cap sheet must be **4.0 mm (0.158")** on the selvage edge in the above applications.
- .4 For smaller sized-projects with a contract value less than \$20,000, standard RCABC 10 year warranty or 2 years maintenance bond option (article 1.6.2) is not required. A qualified roof inspector to be contracted to complete inspection during installation and at post construction, if required. The inspector will be appointed by the Owner.

## 2 Products

### .1 ROOF INSULATION SELECTION NOTES

- .1 Batt insulation installed between roof joists or trusses: Refer to [Division 07 21 00 - Thermal Protection](#).
- .2 Air/Vapour Barrier: Self-adhered air/vapour barrier membranes composed of bitumen modified with thermoplastic polymers and high-density polyethylene film conforming to CGSB 51-GP-56M. The width of the self-adhered membrane shall be 1.14 metres (45") to allow the membrane to fit on the top flute of most structural steel decks. The self-adhesive underface is covered with a silicone release sheet. Water vapour permeability: 0.92 ng/Pa.s.m<sup>2</sup> (0.016 Perm).

### .3 Rigid Polystyrene Insulation

- .1 Expanded Type 1 (low density) and Type 2 (medium density) are generally suitable for conventional roofing applications where the Insulation is under the membrane and over the roof deck.
- .2 Extruded Type 4 (high density) is suitable for conventional applications and is the only type acceptable for use in inverted or protected membrane applications. For inverted or protected membrane a filter mat under the metal flashing must extend 50 mm (2") over the insulation.
- .4 Rigid Polyisocyanurate Insulation: Has the highest thermal resistance but consider that the published thermal resistance may degrade or drift within a relatively short period of time. Insulation panel composed of a closed cell polyisocyanurate foam core manufactured to a premium coated glass facer on both sides. Must conform to CAN/ULC – S704 Thermal Insulation, Polyurethane and Polyisocyanurate, Boards, Faces; using the Long-Term Thermal resistance (LTTR) in accordance with CAN/ULC – S 770. LTTR values are based on ASTM C1289, providing updated 15-year time weighted averages of R-5.6 per inch. Insulation must be multiple layers, non-organic facers, staggered at least 305 mm (12") between layers and mold resistant, scoring a 10 on ASTM D3273.
- .5 Insulation Overlay Board: Multi-ply, semi-rigid asphaltic roofing substrate board at least 4.8 mm (3/16") minimum thickness composed of a mineral fortified asphaltic core formed between two asphaltic saturated fiberglass liners or in conformance with ASTM C1177/C1177M Standard water resistant silicone-treated core, embedded glass mat facing, 6.4, 13 or 15.8 mm (1/4", 1/2", or 5/8") thick UL rated gypsum board.
- .6 Specify that all foamed plastic insulations be CFC & HCFC free and in compliance with the Environmental management Act Ozone Depleting Substances and Other Halocarbons Regulations.
- .7 RCABC requires that all insulation **must be secured to the deck to meet or exceed the Design Wind Loads for the roof area**. Specify that the fasteners be manufactured with corrosion resistant coatings, are of suitable length for the application, and be approved in writing by the insulation manufacturer and the membrane manufacturer.
- .8 Acceptable materials for each category as listed in the RCABC Roofing Practices Manual, **Table of Contents C. Accepted Materials**, latest edition.
- .9 Confirm insulation types with membrane manufacturer.

## .2 ACCEPTABLE MEMBRANE SYSTEM

### .1 2 Ply Flexible Membrane Roofing Systems (SBS – Styrene Butadiene Styrene)

2 ply SBS membranes, conforming to CGSB 37–GP–56M non woven polyester reinforcement. Base sheets must have a minimum thickness of 3 mm (1/8"), 180 g/m<sup>2</sup> reinforcement for mop applications and a minimum thickness of 4 mm (5/32"), 250 g/m<sup>2</sup> reinforcement for torch applications.

Cap sheets must have a minimum thickness of 3.0 mm (1/8") exclusive of granules. Products shall withstand buckling, cracking or granule loss during the warranty period.

### .3 ROOF ACCESSORIES

For SBS use proprietary spun or top welded flange aluminum roof jacks and stacks. Lead roof jacks and stacks are not acceptable on flat or low slope roofing. Field fabricated details are not acceptable unless manufacture provides written confirmation or consultant approval. Where flanged vent is over 1265 cm<sup>2</sup> (196 in<sup>2</sup>) mount it on 203 mm (8") curbs according to manufacturer's recommendations.

### .4 METAL FLASHINGS

- .1 Base and counter flashing metal to be sheet steel, minimum 24 gauge, galvanized to ASTM A653/A653M, Z275 coating, prefinished with Stelcolour 8000 series paint finish finish or equal.
- .2 Use standing seams or "S" Locks acceptable to RCABC.
- .3 All exposed edges of flashings must be hemmed a minimum of 12.7 mm (1/2") for rigidity.

## 3 Execution

- .1 Install membranes to the manufacturer's written installation requirements and published details.
- .2 Ensure that the roof is slope minimum 2% to drain with no pond water.
- .3 Substrate shall be primed as per manufacturer's requirements before applying self adhered moisture/vapor barrier.
- .4 Caulking compounds must not be used as the primary water seal for any roofing application or roofing detail. Specify sealants which are UV resistant and exhibit good adhesion with low modulus. One part urethane sealants are often ideal for general roofing applications. Silicone sealants should not be used for general roofing applications.
- .5 Apply two coats of bituminous paint on each contacting surface between dissimilar metals.
- .6 All metal flashings must be installed to RCABC guarantee standards and standard RCABC flashing details. Form flashings square, true and accurate to size, free from distortion and other defects detrimental to appearance or performance. Ensure that wide girth flashings are adequately sloped to the inside of the roof area and do not pond water.
- .7 Metal flashings are to be securely anchored to continuous blocking or nailers using clips and fasteners suitable for the purpose. All anchoring must meet or exceed RCABC guarantee requirements.
- .8 Use concealed fastening unless otherwise approved by the Consultant.
- .9 Flash copings, roof edges, openings and all items projecting through roofing. Ensure that no flashings pond water and that all drain to the interior of the roof area.

- .10 Protect finished roof from damage and ensure that only authorized traffic and persons can access the finished roof. Install protective walkways when service personnel must access the roof to service equipment.
- .11 Comply with all safe work practices as required by WorkSafeBC, the RCABC Guarantee program and insurance providers.

End of Section

## 07 72 00 - Roof Accessories

### 1 General

- .1 As required by the BC Building Code, AAMA/WDMA/CSA 101/IS2/A440-NAFS, CSA A 440 S1 and as directed by the consultant.
- .2 Submit shop drawings for approval.
- .3 Consultant to ensure that specified fire resistance ratings meet regulatory requirements.
- .4 Air leakage (maximum permitted) – 0.03 L/s/m of crack length with a reference differential pressure of 75 Pa or as directed by the consultant.
- .5 Paints, coatings, adhesives and sealants must not contain methylene chloride and perchloroethylene. Paints and coatings must meet Canadian Volatile Organic Compound (VOC) Concentration Limits for Architectural Coatings Regulations (SOR/2009-264). Adhesives and sealants must meet SCAQMD Rule 1168, effective July 1, 2005.
- .6 Consider using materials that are sourced locally and have high recycled content.

### 2 Products

- .1 Roof Hatch: complies with UL 790, 762 mm x 914 mm (30" x 36"), shop cleaned, degreased and prime-coated/mill finish: 14 gauge (2.9 mm) exterior with 22 gauge (4.6 mm) liner galvanized steel or 11 gauge (2.3 mm) aluminum 25 mm (1") rigid insulation (minimum) roof hatch. Provide manufacture's standard five (5) year warranty.

SPECIFICATIONS	GALVANIZED STEEL/ALUMINUM
<b>Cover</b>	Break-formed, hollow-metal design with 25 mm (1") concealed fiberglass insulation, cover 76 mm (3") beaded, overlapping flange, fully welded at corners, and internally reinforced for 195 kg/m <sup>2</sup> (40 psf) live load.
<b>Curb</b>	305 mm (12") in height with integral cap flashing, 25mm (1") fiberboard insulation, fully welded at corners, and 89 mm (3-1/2") mounting flange with 11 mm (7/16") holes provided for securing frame to the roof deck.
<b>Operating Hardware</b>	Heavy-duty pintle hinges with 9 mm (3/8") Type 316 stainless steel hinge pins. Slam latch with interior and exterior turn handles and padlock hasps. Compression spring operators enclosed in telescopic tubes. Automatic hold-open arm with grip handle release.
<b>Accessories:</b>	Extruded EPDM rubber gasket permanently adhered to cover.
<b>Finish</b>	Mil finish with all welds painted with a rich zinc primer.

- .2 Roof Ladder: Complies with ANSI A14.3, fabricate ladder from steel sections. Provide brackets for permanent fastening to wall construction. Refer to [Division 05 50 00 – Metal Fabrications](#).

# 3 Execution

Not applicable

End of Section

# 07 80 00 - Firestopping and Smoke Seals

## 1 General

- .1 Furnish and install all required firestopping and smoke seals within fire resistive wall and floor assemblies.
- .2 All firestopping and smoke seals shall be listed by Underwriters' Laboratories of Canada (ULC) or Underwriters Laboratories UL that meet the requirements of ULC-S115-M are given a cUL listing and are published by UL in their "Products Certified for Canada (cUL) directory and shall form a draft tight barrier to retard the passage of smoke, flame and hose stream as noted in the appropriate cUL/ULC classification.
- .3 Mechanical and electrical penetrations through fire resistance rated floor, roof and wall assemblies inclusive of cable trays, receptacles, conduits, pipes, sleeves, ducts and poke through devices are to be fully coordinated with **mechanical and electrical divisions respectively**.
- .4 Paints, coatings, adhesives and sealants must not contain methylene chloride and perchloroethylene. Paints and coatings must meet Canadian Volatile Organic Compound (VOC) Concentration Limits for Architectural Coatings Regulations (SOR/2009-264). Adhesives and sealants must meet SCAQMD Rule 1168, effective July 1, 2005.
- .5 Consider using materials that are sourced locally and have high recycled content.

### .6 DESIGN REQUIREMENTS

- .1 All installations and materials are to be to the satisfaction of the Consultant and Authorities Having Jurisdiction. The following criteria must be considered.
- .2 Generally all firestopping for this project shall conform to 'F' rating as per the BC Building Code, except areas of firewalls and parking (parkade) slab to ground floor to conform to 'FT' rating, unless noted otherwise on the drawings.
- .3 Fire protection ratings per CAN4-S115 in all seals.
- .4 FTH fire protection ratings per CAN4-S115 in cable (in excess of 20 mm O.D.) and cable tray penetrations.
- .5 Minimum 10% operational movement of all joints and annuals of mechanical piping and electrical bus duct penetrations.
- .6 Flexible seals for fire damper perimeters and mechanical piping penetrations.
- .7 Complete fire-tested (CAN4-S115) compatibility and operational compatibility without stress corrosion and/or any weakening effects within the following materials and/or combinations thereof in their respective applications:
  - .1 Aluminum (Cable Tray)

- .2 ASJ Vapour Barriers (Insulation, Jacketing)
- .3 Black Steel (Piping, Sleeving & Structural)
- .4 Cast Iron (Piping)
- .5 Communication Cables (minimum 40% tray fill area rating)
- .6 Concrete
- .7 Copper (Piping)
- .8 Galvanized Steel
- .9 Masonry
- .10 Power Cables (Min. 40% tray fill area rating)
- .8 Inspection of installations must be simplified by using identifiable material colours such as red or orange.
- .9 25 mm (1") Head 0.25 kPa (0.035 psi) of water pressure resistance required for all fire stop seals.
- .10 Non-slump ability in wall and overhead applications.
- .11 Re-enterability in cable and cable tray penetrations without use of power tools.
- .12 Minimum 17.6 kg/cm<sup>2</sup> (250 psi) compression strength in cable and cable tray penetrations.
- .13 Only cast-in and/or speed sleeve devices are permitted to penetrate horizontal fire separations.

## **.7 SUBMITTALS**

- .1 Submit complete shop drawings (using architectural floor plans); show all locations of all firestop seals including all electrical and mechanical seals. Indicate applicable listed cUL/ULC system and design number as applicable. Show all fire rated walls and floor penetrations. Show all penetrations and develop an indexing (identification) system. Shop drawings must include VOC limits.
- .2 Shop drawings to be submitted and reviewed prior to forming of concrete openings and placement of sleeves by electrical and mechanical subtrades.
- .3 Submit firestop seal details and confirmation of cUL/ULC system listings. Show any variations, limitations or areas where listings are expected to be exceeded.
- .4 Provide copies of reviewed shop drawings to all affected subtrades.
- .5 Submit, upon completion, **one hard copy and one soft copy** of maintenance manuals for the Owners' future use. Include product names, applicator, installation instructions, cUL/ULC listings, manufacturer's literature, etc.

## **.8 QUALITY ASSURANCE**

- .1 All work to be of the highest quality according to best trade practice and in strict accordance with manufacturer's printed trade specifications, by an approved specialist firestopping caulking firm employing only skilled tradesmen.

- .2 Submit upon completion, signed copies of letters of assurance confirming conformity to reviewed shop drawings and complete firestopping and smoke seal system including Division 15 and 16.
- .3 For those firestop applications that exist for which no ULC or cUL tested system is available through a manufacturer, a manufacturer's engineering judgement derived from similar ULC or cUL system designs or other tests will be submitted to local authorities having jurisdiction for their review and approval prior to installation.
- .4 A manufacturer's direct representative (not agent or distributor) to be on site during initial inspection of firestop systems to train appropriate contractor personnel in proper selection and installation procedures.
- .5 Manufacturer to have Fire Protection Specialist on staff.

## 2 Products

- .1 Firestop Caulking Compound: Minimum requirements – National Standards System specifications as applicable and as listed above.
- .2 Approved Firestop Caulking (Sealants) Compound: Only those products tested, approved and listed in the cUL/ULC – List of Equipment and Materials – Volume II – Building Construction may be used and only within specific firestop joint locations as listed.
- .3 Obtain firestopping products from one manufacturer. Contractor to co-ordinate with all trades.
- .4 Wall opening protective materials to conform with cUL/ULC.
- .5 Identification:

Identify areas of re-enterability requiring through-penetration firestop systems with pressure-sensitive, self-adhesive, pre-printed vinyl labels. Attach labels permanently to surfaces of penetrated construction on both sides of each firestop system identification. Include the following information on the label:

  - .1 The words: "Warning – through penetration firestop system – do not disturb. Notify Building Management of any damage".
  - .2 Installing contractor's name, address, and phone number.
  - .3 Through-penetration firestop system designation of applicable testing and inspecting agency.
  - .4 Date of installation.
  - .5 Through-penetration firestop system manufacturer's name.
  - .6 Installers name.

# 3 Execution

## .1 SEQUENCING

- .1 No installation is to proceed unless review and return of shop drawings has been completed.
- .2 Schedule installation of CAST IN PLACE firestop devices after completion of floor formwork, metal form deck, or composite deck but before placement of concrete.
- .3 Schedule installation of Drop-in firestop devices after placement of concrete but before installation of the pipe penetration. Diameter of sleeved or cored hole to match the listed system for the device
- .4 Firestopping to floor and roof slab penetrations must precede drywall track installation.
- .5 Firestopping must precede fireproofing installation.
- .6 Firestopping at slab edge detail to exterior wall panels and at window panels must be done with wall panel installations.
- .7 Firestopping must precede mechanical pipe insulation (vapour barriers must be continued along with FPI – ASJ jacketing).
- .8 A pre-review walk through conducted by manufacturer’s direct representative, with a representative from each associated contractor for the work. Manufacturer is to provide a written summary, in the form of a letter, of the visual observations. No inference of contractors adherence to correct installation practices in unobserved firestop applications is implied, or are to be drawn from, in this letter.

End of Section

# 07 92 00 - Joint Sealants

## 1 General

- .1 As required by the current BC Building Code and as directed by the Architect and Building Envelope Consultant.
- .2 Paints, coatings, adhesives and sealants must not contain methylene chloride and perchloroethylene. Paints and coatings must meet Canadian Volatile Organic Compound (VOC) Concentration Limits for Architectural Coatings Regulations (SOR/2009-264). Adhesives and sealants must meet SCAQMD Rule 1168, effective July 1, 2005.
- .3 Provide joint sealants for interior applications that establish and maintain airtight and water-resistant continuous joint seals without staining or deteriorating joint substrates.
- .4 Sealants refer to CAN/CGSB 19 series or ASTM C920 for conditions with non-staining colours that match to adjacent surfaces. Colours to be approved by Consultant from manufacturer's full range.
- .5 Install in accordance with ASTM C1193 and manufacturer's instructions unless noted otherwise.
- .6 Ensure compatibility of sealants to the substrate or adjacent materials.

## 2 Products

### .1 POLYETHYLENE FOAM BACKUP ROD

Closed cell polyethylene, urethane, neoprene or vinyl foam backer rod conforming to ASTM D1056 compatible with primers and sealants as recommended by sealant manufacturer with Shore A hardness of 20, tensile strength from 140 to 200 kPa and diameter 30% greater than the width of the joint (where it will be installed).

### .2 POLYURETHANE SEALANT (2 & 3 PART)

Conform to CAN/CGSB 19.24 Type M Class 25, for exterior locations at joints between dissimilar construction, around penetrations through exterior walls, roofs and floors, metal flashing, brick veneer control joints, around window frames and doors, vinyl/fibre cement siding and pressed steel door frames.

### .3 POLYURETHANE SEALANT (1 PART)

Conform to CGSB CAN/CGSB 19.13 Type S Class 25 Grade NS for locations between interior pressed steel frames, concrete and masonry; stud wall plates to surrounding construction in exterior walls, penetrations through interior layer of gypsum wallboard, floors and ceilings where the "Airtight Drywall Approach" is used to control air leakage.

#### **.4 SILICONE SEALANT**

Conform to CAN/CGSB 19.13M, Type II, non-sag (NS), + 40% movement capacity, applicable to control joints, penetration through exterior walls, roof, floors, and metal flashing. Conform to ASTM C920 Type S Grade NS Class 25 use NT, G & A for junction of washroom fixtures to floors, vanities to walls and countertops, behind plumbing escutcheons in tubs and showers, joints between tub enclosures and tubs, between finished resilient flooring and door frames, resilient floor/wall junction prior to installation of the base boards, resilient flooring/baseboard junctions, walls/top of the baseboard and resilient floor/kitchen cabinet junctions.

Use white against white fixtures and clear in other locations. Conform to ASTM C 1248 for non-staining to porous substrates.

#### **.5 ACOUSTICAL SEALANT**

Non-hardening sealants conforming to CAN/CGSB 19.21 and effectively reduces airborne sound transmission through perimeter joints and openings as demonstrated by testing representative assemblies according to ASTM E90. Use sealants in sound-rated gypsum wallboard partitions, all end and lap joints in polyethylene vapour barriers, stud plates top and bottom, junction of vertical studs with dissimilar materials, around penetrations in walls and as required by rated assembly specifications.

#### **.6 BOND BREAKER TAPE**

Polyethylene tape/plastic tape recommended by sealant manufacturer, applied to sealant contact surfaces where bond to substrate or backer rod must be avoided for proper performance of sealant. Provide self-adhesive tape where applicable.

## 3 Execution

- .1** Examine joint sizes and conditions to establish correct depth to width relationship for installation of backup material and sealants. Prepare and prime surfaces in accordance with the manufacturer's directions. Use joint backup material to control the depth of joint to the sealant manufacturer's recommended thickness.
- .2** Apply sealant in accordance with the manufacturer's directions with sufficient pressure to properly fill all voids and seal the joint. Apply compounds in continuous beads, without open joints, voids, air pockets or embedded impurities.
- .3** The surface of all caulking must be smooth, free from ridges, wrinkles, sags and air pockets. Tool exposed surfaces to give a slightly concave shape and ensure full contact with inner face of joint.
- .4** Remove excess compound promptly as work progresses and upon completion using cleaners recommended by the manufacturer.

End of Section

# 08 11 00 - Metal Doors and Frames

## 1 General

- .1 Supply and install as required by the BC Building Code for exterior and interior doors, and as directed by the Architect and/or Building Envelope Consultant.
- .2 Doors and frames to exit stairs and service rooms and suite entrance frames from public corridors must conform to Canadian Steel Door and Frame Manufacturer's Association (CSDFMA), Manufacturing Specifications for Steel Doors and Frames.
- .3 Fire-Rated Door Assemblies complying with NFPA 80 are listed/labeled by ULC/WH (Warnok Hersey) acceptable to authorities having jurisdiction for fire protection ratings indicated. Materials not less than the thickness specified herein, unless a greater thickness is specified in the rating requirements.
- .4 Submittals: prior to fabrication clearly indicating manufacturer, door frame, elevations, dimensions, fastening, reinforcing, thickness, hardware, reinforcement details, opening requirements for glazing, quality of materials, shop finishes, fabrication details, installation requirements and wall condition/anchorage details. Include schedule identifying each unit, with door marks and numbers relating to numbering on drawings and door schedule of the Architect.
- .5 Maximum glazing, area of fire rated glass, fire rating, requirements of the hold open device activated by the fire alarm and temperature rise rating as governed by BC Building Code and NFPA 80.
- .6 Exterior doors must meet the requirements of AAMA/WDMA/CSA 101/IS2/A440-NAFS and CAN/CSA A440S1 - Canadian Supplement. Provide minimum ratings as specified by the building envelope consultant.
- .7 Consider using materials that are sourced locally and have high recycled content.
- .8 Paints, coatings, adhesives and sealants must not contain methylene chloride and perchloroethylene. Paints and coatings must meet Canadian Volatile Organic Compound (VOC) Concentration Limits for Architectural Coatings Regulations (SOR/2009-264). Adhesives and sealants must meet SCAQMD Rule 1168, effective July 1, 2005.
- .9 Consider using materials that are sourced locally and have high recycled content.

## 2 Products

- .1 Door and frame product shall be manufactured from Commercial Steel (CS) dry passivated, Type B to ASTM A924. Galvanized to ASTM A653, coating designation Z275 for exterior and ZF075 for

interior doors, zinc coating prior to fabrication.

- .2 Metal door frames in wood frame construction can be “knock down” or welded frame type. Only welded frames to be used for exterior doors.
- .3 Attach fire rated label to hinge side of door.
- .4 Exterior Service Room, Exit Doors
  - .1 **Thickness:** 45 mm (1-3/4”).
  - .2 **Door Construction:** Minimum 18 gauge galvanized steel.
  - .3 **Style:** Flush – hollow metal panel design. Flush doors are defined as those without visible seams on faces of doors.
  - .4 **Core:** Polyurethane insulation, thermally broken. Batt insulation is not acceptable.
  - .5 **Finish:** Prime painted for site finishing.
  - .6 **Sill:** Thermally broken extruded aluminum.
  - .7 **Weatherstripping:** mechanically fastened, extruded aluminum with neoprene inserts and adjustable sweep at sill.
  - .8 **Frame:** Thermally broken hollow metal frame. Insulate with slab polyurethane insulation or spray insulation.
  - .9 **Rain Drip:** Provide cover or aluminum rain drip at head of door frame.
- .5 **SERVICE/MECHANICAL ROOMS, INTERIOR EXIT DOORS**
  - .1 **Door Construction:** 18 gauge galvanized steel.
  - .2 **Finish:** Prime painted for site finishing.
  - .3 **Frame:** hollow metal frame.
  - .4 **Door frames for concrete and concrete block walls:** coating designation ZF075, wiped zinc coated.
  - .5 **For corridor door weatherstripping:** mechanically fastened, extruded aluminum with neoprene inserts and adjustable sweep at sill.
- .6 **FIRE RATED METAL DOORS & FRAMES**
  - .1 **Door Construction:** 18 gauge, material and construction in accordance with requirements of ULC or WHI for class of door opening indicated
  - .2 **Finish:** Prime painted for site finishing.
  - .3 **Frame:** Frame and sidelights minimum of 16 gauge (1.52 mm).

# 3 Execution

## .1 SITE STORAGE AND PROTECTION OF MATERIALS

- .1 Protect the door and door frames; keep them free from scratches, disfigurement and dents.
- .2 Store the doors in a vertical position, and be spaced with blocking to permit air circulation between them. Doors and frames are to be stored in a manner to prevent any warping and twisting.

## .2 INSTALLATION

- .1 Doors are to be installed plumb, square and level. Ensure that doors can swing out fully without obstruction.
- .2 Fire-rated door and frame product shall be installed in accordance with the terms of their listings, NFPA, and/or the local Authority Having Jurisdiction (AHJ).
- .3 While setting the frame, check and correct as necessary for opening width, opening height, square, alignment, twist and plumb, in accordance with the CSDMA, "Recommended Dimensional Standards for Commercial Steel Doors and Frames".
- .4 Secure anchorage and connections to adjacent construction. Coordinate to detail for maintaining continuity in air barrier and thermal protection.

End of Section

# 08 14 00 - Wood Doors and Frames

## 1 General

- .1 Wood doors must conform to the Quality Standards Illustrated (QSI) for Architectural Woodwork as published by the Architectural Woodwork Manufacturers Association of Canada (AWMAC).
- .2 Wood products are recommended to have certification according to the requirements of one of the four internationally recognized third-party audited certification systems: Forest Stewardship Council (FSC), CSA CAN/CSA Z809, Sustainable Forestry Initiative (SFI), Program for Endorsement of Forest Certification Systems (PEFC) or other product programs mutually recognized by PEFC.
- .3 Composite Wood to comply with California Air Resources Board (CARB) ultra-low-emitting formaldehyde (ULEF) resins or no added formaldehyde resins. Composite wood cannot exceed 0.05 ppm of formaldehyde as tested under EN-717-1:2004, ISO 16000-3:2010, ISO 16000-6: 2011, ISO 16000-9:2006, ISO 16000-11:2006 or CEN/TS 16516: 2013. Use low VOC content adhesives.
- .4 Products used are considered to be local available and have high recycle content. Comply with requirements in NFPA-80 and BCBC for fire-rated doors. Conform to CAN/ULC S104 for fire rated doors. Fabricate non-rated doors in accordance with QSI requirements.
- .5 Glazed door lites must meet the requirements of AAMA/WDMA/CSA 101/IS2/A440-NAFS and CAN/CSA A440S1 - Canadian Supplement. Provide minimum ratings as specified by the building envelop consultant.
- .6 All wood doors and frames shall be guaranteed by the manufacturer for a period of not less than three (3) years after the substantial completion against stile, rail, core show-through or deformation in the surfaces as determined under AWMAC.

## 2 Products

### .1 EXTERIOR SOLID CORE DOORS (SOLID CORE)

- .1 **Door Core:** Stave lumber core, rated as applicable for fire requirements
- .2 **Door Faces:** Flush face with tempered glazed panel (if required), medium density overlay, primed & finish paint as [Division 09 91 00 - Painting](#).
- .3 **Frames:** Aluminum-framed or fire rated finger joined SPF, primed for a paint finish.

### .2 INTERIOR UNIT ENTRANCE DOORS (SOLID CORE)

- .1 **Door Core:** Particle board or solid wood stave; core fully glued and bonded. Rated for applicable fire requirements.
- .2 **Door Faces:** Flush tempered hardboard, primed for a paint finish. Refer to [Division 09 91 00-Painting](#).

- .3 **Frames:** Fire rated finger joined SPF, primed for a paint finish or metal frames.

Solid core interior doors can be considered for interior doors depending on the residents. Consult with BC Housing for this requirement.

### .3 INTERIOR DOORS, PASSAGE/BI PASS AND BI FOLD (HOLLOW CORE)

- .1 **Door Core:** Expanded honeycomb
- .2 **Door Faces:** Flush tempered hardboard, primed for a paint finish. Refer to [Division 09 91 00 - Painting](#).
- .3 **Frames:** Finger joined SPF, primed for a paint finish or metal frames. Provide valence to cover exposed tracks.

### .4 POCKET DOORS

- .1 **Door Core:** Expanded honeycomb
- .2 **Door Faces:** Flush tempered hardboard, primed for a paint finish. Refer to [Division 09 91 00 - Painting](#).
- .3 **Hardware:** Provide for tri-wheel track and hardware system, with accessories necessary to assure a smooth, warp-free and quiet operation. Provide robust D-pulls with the pulls made specifically for back to back mounting.

### .5 DOOR HARDWARE AND ACCESS CONTROL

- .1 Refer to [Section 08 70 00 - Hardware](#) and [Section 08 71 50 - RFID Proximity Card Locking System](#). Review and coordinate with electrical and security requirements.

## 3 Execution

### .1 SITE STORAGE AND PROTECTION OF MATERIALS

- .1 Protect the door and door frames; keep them free from scratches, disfigurement and dents.
- .2 Store the doors in a vertical position, and be spaced with blocking to permit air circulation between them. Doors and frames are to be stored in a manner to prevent any warping and twisting.

### .2 INSTALLATION

- .1 Doors are to be installed plumb, square and level. Ensure that doors can swing out fully without obstruction.
- .2 While setting the frame, check and correct as necessary for opening width, opening height, square, alignment, twist and plumb, in accordance with the AWMAC.
- .3 Consultant shall ensure that pocket doors walls do not support vertical or lateral loads (such as wall-hung fixtures, grab bars, etc) unless appropriate design measures are taken to support such loads.

End of Section

# 08 33 23 - Overhead Parkade Doors

## 1 General

- .1 Design and locate the overhead parkade door to reduce vandalism and theft, refer to [Crime Prevention Through Environmental Design](#) section.
- .2 Coordinate the gate operation with the Owner's Building security access system, if required.
- .3 Paints, coatings, adhesives and sealants must not contain methylene chloride and perchloroethylene. Paints and coatings must meet Canadian Volatile Organic Compound (VOC) Concentration Limits for Architectural Coatings Regulations (SOR/2009-264). Adhesives and sealants must meet SCAQMD Rule 1168, effective July 1, 2005.
- .4 Consider using materials that are sourced locally and have high recycled content.

## 2 Products

### .1 GATE

- .1 **Type:** Open grille, aluminum, sectional, upward acting.
- .2 **Construction:** Two (2) horizontal sections comprising of 51 mm x 75 mm (2" x 3") tubular aluminum frame with 16 mm (5/8") square aluminum pickets spaced at 127 mm (5") o.c. vertically with closer spacing as required for security at attachment and activation points.
- .3 **Finish:** Painted finish

### .2 GATE HARDWARE

- .1 **Type:** 75 mm (3") heavy duty, low headroom, double track hardware.
- .2 **Tracks:** 75 mm (3") x 12 gauge commercially galvanized formed steel with double horizontal track and continuous angle for vertical stiffening.
- .3 **Rollers:** 75 mm (3") in diameter with 178 mm (7") long axles. Rollers must be nylon long life precision bearing type.
- .4 **Roller brackets and hinges:** Fabricated from 12 gauge commercially galvanized steel.
- .5 **Counterbalance mechanism:** Torsion springs mounted on 25 mm (1") diameter solid steel shaft, grooved precision drums and flexible aircraft cables. Springs must be designed for 200,000 cycles.
- .6 **Rubber pads:** Rubber pads to be mounted between ceiling slab, track supports and motor operator supports. Track supports must incorporate mylar strips to further reduce noise.

### .3 OPERATION

- .1 **Motors:** Supply and securely mount motor suitable to operate door of dimensions specified and weight supplied with additional reserve power (minimum 1/2 hp), heavy duty V-belt, #41 chain, an instant magnetic reversing starter, emergency disconnect and all necessary accessories.
- .2 **Power supply:** Single phase, 60 Hz. Coordinate with Electrical Contractor for connection to power supply, and disconnect switches.
- .3 **Key:** Provide 2 (two) remote control key cards to parking garage entry for each parking stall and two (2) for maintenance.
- .4 **Treadle Car Detector:** on interior side of door to operate door as vehicle approaches.
- .5 **Closing:** Activated by an adjustable timer from 0 to 3 minutes.
- .6 **Door Bottom Safety Switch:** electro-mechanical unit for full length of bottom rail of bottom section of door, to reverse door to open position when coming in contact with object on closing cycle.
- .7 **Safety Features:** a pair of infra-red safety eyes shall be mounted on either side of the gate opening beyond the reach of unauthorized persons from exterior. In addition, a safety device/sensor to be added on the bottom rail of the door to sense an obstruction during closing/opening cycle and to contact motor to reverse to open.
- .8 **Control transformer:** for 24V AC control voltage.
- .9 **Power Failure:** In the event of a power failure, operator must be capable of being released from door by use of a quick release door arm for manual operation.
- .10 **Control & Access security system:** Coordinate with electrical and hardware section for receiver locations and card readers [Section 08 71 50 - RFID Proximity Card Locking System](#).

## 3 Execution

- .1 Ensure that the clearance between the moving parts of a gate and adjacent surfaces shall prevent injury or entrapment of anyone attempting to intrude between the gate and the adjacent surface, but in no case shall the clearance be greater than 102 mm (4").
- .2 Provide interconnecting wiring for a complete system to controller.

End of Section

# 08 41 00 - Aluminum Entrances and Storefronts

## 1 General

- .1 Supply and install storefront framing and doors, including deflection channels, sill tracks, sill flashings, glass, glazing and hardware.
- .2 DESIGN AND PERFORMANCE REQUIREMENTS:**
  - .1 Structural design: design glass, framing members, and anchorage to the requirements of the BC Building Code for wind, seismic, guard, and human impact loads. Allow for deflection of building structure. Ensure no structural loads are imposed on storefront framing or doors. Engage Registered Professional Engineer to review structural design and attachment to building structure, seal shop drawings, carry out field reviews, and submit sealed letter of assurance stating that the window and door installation conforms to sealed shop drawings.
  - .2 Air leakage through the fixed lite areas of the storefront not to exceed 0.3 L/s·m<sup>2</sup> at 75 Pa when tested to ASTM E 283.
  - .3 Water penetration resistance: no uncontrolled water penetration when tested to ASTM E 331 at a test pressure of 290 Pa.
  - .4 Comply with BC Energy Efficiency Standards Regulation for manufactured fenestration products.
  - .5 Thermally broken, the grid members shall have a condensation resistance equal to or better than the area along the bottom of a 25 mm (1") sealed glass unit with standard metal spacer edge construction.
- .3 WARRANTY:**

Sealed units to have a minimum warranty period of ten (10) years against failure of glazing unit seals and deposits on interior glass faces detrimental to vision.
- .4 QUALITY ASSURANCE:**
  - .1 Submit shop drawings showing design loads, frame reinforcing, insulating glass makeup, installation clearances, expected building deformations, as well as shimming and anchorage requirements for the expected design loads for that location. Show all sealants, flashings and membranes required to ensure continuity of building envelope critical barriers to the fenestration system. Shop drawings shall bear the seal of a professional engineer registered in British Columbia.
  - .2 Submit certified copies of laboratory test reports from an approved independent testing agency to demonstrate storefront system compliance with air infiltration and water penetration resistance requirements.
  - .3 Submit written evidence of insulating glass certification to ASTM E 2190. The certification must apply to the insulating glass makeup used in the fenestration products.

- .4 Submit Schedule S-B Assurance of Design and Schedule S-C Assurance of Field Review for fenestration product design and anchoring on completion of the installation.
- .5 Paints, coatings, adhesives and sealants must not contain methylene chloride and perchloroethylene.  
Paints and coatings must meet Canadian Volatile Organic Compound (VOC) Concentration Limits for Architectural Coatings Regulations (SOR/2009-264). Adhesives and sealants must meet SCAQMD Rule 1168, effective July 1, 2005.
- .6 Consider using materials that are sourced locally and have high recycled content.

## 2 Products

### .1 STOREFRONT FRAMING AND DOORS

- .1 Extruded aluminum storefront framing, door framing, deflection channels, sill tracks, and operable vents in storefront framing to incorporate integral thermal breaks in all members, Aluminum Association alloy and temper AA-6063-T5.
- .2 Sill flashings and frame anchorage to be designed and installed to minimize thermal bridging
- .3 All fasteners shall be aluminum, non-magnetic stainless steel or other materials warranted by manufacturer to be non-corrosive and compatible with aluminum components.
- .4 For shelter or hard to house projects, provide electronic locks at main entry doors that can be controlled by office staff at reception. Coordinate with BC Housing, Consultant, electrical and security contactors.

### .2 SWING DOOR HARDWARE

- .1 Closer: overhead, exposed, single acting, parallel arm, fully adjustable for barrier free opening, full metal cover, sized to suit door opening width, door weight and service application, finish to match door finish.
- .2 Offset top and bottom ball bearing pivots, and 305 mm (12") high steel security latch protector plate.
- .3 Provide top and bottom flush: hollow metal bolts on inactive leaf of double doors.
- .4 Provide stainless steel push/pulls and wheel chair accessible threshold.
- .5 Refer to [Division 08 70 00 - Finish Hardware](#) and [Section 08 71 50 - RFID Proximity Card Locking System](#) for detailed requirements.

### .3 POWER-OPERATED SWING DOORS

- .1 Power-operated swing door shall meet the requirements of ANSI A156.10, ANSI 156.19 and CSA/ULC.
- .2 **Equipment:**
  - .1 Completely assembled and sealed unit which shall include helical gear-driven transmission,

overriding clutch (to provide easy manual operation, spring-close), mechanical spring/bearings and filled with special lubricant for extreme temperature conditions. Attached to transmission system shall be a DC shunt-wound permanent magnet motor with sealed ball bearings.

- .2 Housing – extruded aluminum fully enclosed housing with finished end caps, surface mounted to the door frame.

### **.3 Operation:**

- .1 Exterior entry: provide exterior mounted operating switch with tamperproof card reader. Coordinate operation of automatic opener with entry phone for visitor access. For shelter and hard to house clients, access control is operated by office staff at reception. Consult with BC Housing for this requirement.
- .2 Interior: provide stainless steel push plate switch, minimum 114 mm (4-1/2") diameter with wheelchair symbol.
- .3 Manual operation – in the event of a power failure the door shall close as if equipped with a manual door closer and shall open with a force in accordance with ANSI 156.19.

### **.4 Features:**

- .1 The control shall include an adjustable (0 to 60 seconds) time delay module
- .2 Weatherstripping at the interface between doors, frame and sidelight panels. Refer to [Division 08 70 00 – Finish Hardware](#).
- .3 Automatic locking system.
- .4 Provide an electric strike connected to operating devices. [Section 08 71 50 – RFID Proximity Card Locking System](#).
- .5 Self-contained unit including necessary transformer, relays, rectifiers, and other electronic components for proper operation. Relays shall be plug-in type for individual replacement.
- .6 Door operation shall not require any fluids or gases under pressure to be used in opening and closing of door.
- .7 Manual door operation requires less than 12 lbs of force applied to door stile.

## **.4 GLASS AND GLAZING**

- .1 Glass thickness and heat strengthening: to be determined according to CAN/CGSB-12.20-M. Thickness and heat treatment of clear glass may be adjusted to suit structural requirements but shall not be less than 5 mm thick.
- .2 Insulating glass units shall be of dual seal construction certified for durability and argon gas retention to ASTM E 2190.
- .3 Insulating glass to be multiple glazed with at least one low-E coating between panes, a 90% argon gas fill level with a compatible edge sealant system and have spacer bars other than non-thermally broken aluminum box spacer bars.

**.4 Sealants**

Refer to [Division 07 92 00 - Joint Sealants](#); use 2 part urethane to exterior and 1 part urethane to interior.

**.5 Air Barrier**

Maintain continuity of air barrier at junction with entrances and storefront.

**.6 Finish**

Factory applied thermo setting acrylic enamel coating in accordance with Architectural Aluminum Manufacturer's Association Specification AAMA 2603 or anodized to AA - M12C22A31 as selected by Design Consultant.

## 3 Execution

Not Applicable

End of Section

# 08 50 00 - Windows, Side Hinged and Sliding Glass Doors

## 1 General

### .1 REFERENCES

- .1 AAMA/WDMA/CSA 101/I.S.2/A440, NAFS North American Fenestration Standard/Specification for windows, doors and skylights.
- .2 CSA A440S1, Canadian Supplement to AAMA/WDMA/CSA 101/I.S.2/A440 NAFS North American Fenestration Standard/Specification for windows, doors and skylights.
- .3 CAN/CSA-A440.4 Window, Door, and Skylight Installation.
- .4 CAN/CGSB-12.20 Structural Design of Glass for Buildings.
- .5 IGMA TM-3000 North American Glazing Guidelines for Sealed Insulating Glass Units for Commercial & Residential Use.
- .6 ASTM E1105 Field Determination of Water Penetration of Installed Exterior Curtain Walls and Doors, by Uniform or Cyclic Static Air Pressure Difference.
- .7 ASTM E 2190 Standard Specification for Insulating Glass Unit Performance and Evaluation.
- .8 Current versions of the BC Building Code, BC Energy Efficiency Standards Regulation, Vancouver Building By-Law (VBBL), and Local Government Act.
- .9 Building Enclosure Design Guide - Wood-Frame Multi-Unit Residential Buildings (Homeowner Protection Office - HPO, most recent edition) for guidance on window and door installation detailing.
- .10 Best Practices for Window and Door Replacement in Wood Frame Buildings (Homeowner Protection Office - HPO, most recent edition).

### .2 DESIGN AND PERFORMANCE REQUIREMENTS

- .1 Windows, side hinged doors and sliding glass doors (hereafter called the fenestration products) shall conform to AAMA/WDMA/CSA 101/I.S.2/A440 and CSA A440S1, and have the following minimum tested performance ratings:
  - .1 Performance Class - to be selected according to the intended building usage:

Class R	for modular residences
Class LC	for group homes, medium-density residential such as townhomes, and low-rise apartments (up to 4-storey)
Class CW	for high-density residential (more than 4 storeys), elementary and secondary schools

- .2 Performance Grade – For Part 9 buildings, Performance Grades should be selected according to the Canadian Supplement CSA A440S1. For Part 3 buildings the architect may determine Performance Grades that will be used together with Performance Class to prequalify and select products. Performance Grade shall not be less than PG35.
- .3 Water Penetration Resistance Test Pressure – to be determined in accordance with CSA A440S1, but in no case shall it be less than 290 Pa for buildings up to four storeys, or 510 Pa for buildings taller than four storeys. For patio doors on four storey buildings and higher shall be at minimum 330 Pa, lower requirements shall require BC Housing and Consultant's approval.

AAMA/WDMA/CSA 101/I.S.2/A440 requires products supplied with screens to be laboratory tested for water penetration resistance both with screens and without screens.
- .4 Air Infiltration/Exfiltration Level: A-3 for operable windows; "Fixed" for non-operable windows.
- .2 Insulating glass units shall be of dual seal construction certified for durability and argon gas retention to ASTM E 2190.
- .3 Multifamily and Part 3 Buildings
  - .1 Design and manufacture fenestration products and product anchoring to the building structure to meet all applicable building code loads for the building height and location, including wind loads, seismic loads, human impact loads, guard loads, seismic movements, and other expected movements and deformations of the building structure. Deflection of all glass supporting members to be limited to L/175 in class CW and AW.
  - .2 For the purposes of the fenestration product design and anchoring appropriate design wind pressures should be determined for building locations and terrain. The design pressure determined by the responsible engineer may differ from the Performance Grade used to prequalify products on the basis of NAFS tested performance ratings.
  - .4 The design of the windows should consider the daily light exposure, building orientation, overheating and passive strategies to meet BC Housing energy target. Refer to [Energy and Sustainable Design](#) section.
  - .5 Fenestration products shall be labeled to show an overall product U-value of  $U \leq 1.4 \text{ W/m}^2\cdot\text{°K}$  ( $0.25 \text{ Btu/h}\cdot\text{ft}^2\cdot\text{°F}$ ) or less as required by the BC Energy Efficiency Standards Regulation and depending on BC Housing energy target for that climate zone. U-value labels shall bear the mark of a recognized certification agency.
  - .6 Fenestration product installation details shall provide sub-sill drainage to provide a secondary or back-up drainage path to prevent water ingress into the wall framing below in case of leakage past the water shedding surfaces of the window frame and the adjoining wall.
  - .7 Fenestration products shall comply with the Canadian Operating Force Requirements in AAMA/WDMA/CSA 101/I.S.2/A440.
  - .8 Ensure replacement windows meet all current building code requirements (example; sill heights for operable windows and restrictor requirements).
  - .9 Avoid the use of skylights in the project.
  - .10 Paints, coatings, adhesives and sealants must not contain methylene chloride and

perchloroethylene. Paints and coatings must meet Canadian Volatile Organic Compound (VOC) Concentration Limits for Architectural Coatings Regulations (SOR/2009-264). Adhesives and sealants must meet SCAQMD Rule 1168, effective July 1, 2005.

- .11 Consider using materials that are sourced locally and have high recycled content.
- .12 To specify the solar heat gain coefficient (SHGC) for the fenestration products depends on building orientation, shading from surrounding buildings and structures and amount of overhang. **All windows are to have a maximum SHGC of 0.3. Windows with high exposure to summer sun can be considered for a lower coefficient.** The consultant shall specify the SHGC in the construction documents for different exposures and elevation of the building.

### .3 PRE-INSTALLATION LABORATORY TESTING

- .1 Pre-installation laboratory tests are required under certain conditions, as determined by the Design Consultant in consultation with the Owner:
  - .1 When fenestration product(s) are of a size and/or a configuration not previously tested to AAMA/WDMA/CSA 101/I.S.2/A440 by the fenestration supplier.
  - .2 When the fenestration product supplier is relying on the test reports of a third party for the AAMA/WDMA/CSA 101/I.S.2/A440 performance ratings of their products, a practice permitted in some certification programs.
  - .3 When using suppliers whose products have never previously been field tested for water penetration resistance.
  - .4 When a greater level of quality assurance is required, such as buildings subjected to very high driving rain wind pressures (coastal open terrain).
- .2 Pre-installation laboratory tests, when required, shall be conducted on at least one full-size sample taken from each batch of windows or doors manufactured for the project. The test data shall be submitted to the Consultant for review and approval prior to installation. Include cost of testing and retesting (if failed) in the contract price.
  - .1 Products shall be tested to the requirements of AAMA/WDMA/CSA 101/I.S.2/A440 and CSA A440S1 to determine they comply with the specified Performance Class and Grade, Water Penetration Resistance Test Pressure, and Canadian Air Infiltration/Exfiltration Level.
  - .2 Products shall be installed into the test buck in the same way as shown on the architectural drawings for the building. No additional shimming or anchoring of the test specimen shall be permitted. Consultant to approve test specimen installation prior to product testing.

### .4 SUBMITTALS

- .1 Submit written evidence of insulating glass certification to ASTM E 2190. The certification must apply to the insulating glass makeup used in the fenestration products.
- .2 Submit certified copies of test results from an approved independent testing agency to confirm compliance with the minimum specified AAMA/WDMA/CSA 101/I.S.2/A440 Performance Class and Grade.
- .3 Shop drawings: submit shop drawings of fenestration products showing design loads, frame

reinforcing, insulating glass makeup, installation clearances, expected building deformations, as well as shimming and anchorage requirements for the expected design loads for that location. Shop drawings shall bear the seal of a professional engineer registered in British Columbia.

Shop drawings may be used to report the AAMA/WDMA/CSA 101/I.S.2/A440 Performance Class, Performance Grade, Water Penetration Resistance Test Pressure, and Air Infiltration/Exfiltration Level of the fenestration products in place of individual labels applied to the products. It is understood that the engineer's seal on the shop drawings does not constitute an endorsement or certification of the AAMA/WDMA/CSA 101/I.S.2/A440 performance information.

- .4 Submit Schedule S-B Assurance of Design and Schedule S-C Assurance of Field Review for fenestration product design and anchoring on completion of the installation.

## .5 MOCK-UP

- .1 Install a window and/or sliding glass door mock-up, complete with tie-ins to adjacent materials and assemblies to demonstrate the required sequence of installation, for the Consultant's approval.
- .2 Field test the mockup to verify that installed product and interface with surrounding construction complies with specified water penetration resistance test pressure.

## .6 FIELD TESTING

- .1 Selected installed fenestration products shall be tested for water penetration resistance in accordance with ASTM E 1105. The test Procedure shall correspond to the method of test used to qualify the product for water penetration resistance under AAMA/WDMA/CSA 101/I.S.2/A440. The Water Penetration Resistance Test Pressure shall be as indicated in this specification. The test chamber shall be installed so as to test both the product and the interface joint to the adjacent wall. The pass/fail criteria for the test shall be as defined in CSA A440S1 Clause 5.4.
- .2 The minimum number of products selected for field testing are shown below.

TOTAL NUMBER OF PRODUCTS*	PRIOR TO 5% INSTALLED	AT 50% INSTALLED	AT 100% INSTALLED
0 - 25	1	0	0
25 - 100	1	0	0
100 - 200	2	1	0
> 200	3	2	2

\* Windows, sliding doors, and side hinged doors shall be field tested as shown in this table according to the quantity of each on the project.

- .3 Where modifications are necessary to the window assembly or wall interfaces to achieve the required performance, the contractor shall undertake required modifications to the manufacturing or installation process to the satisfaction of the Building Envelope Consultant. This Consultant is to ensure that the required modifications in this process do not void or compromise the manufacturer's warranty.
- .4 Include cost of field testing in the contract price. The Contractor will pay for any re-testing

required as a result of failures. For renovation projects, the Owner may choose to have the consultant to engage the testing firm independently.

## .7 WARRANTY

- .1 Sealed units to have a minimum warranty period of twenty (20) years against failure of glazing unit seals and deposits on interior glass faces detrimental to vision.
- .2 Fenestration product frames to have a minimum warranty period of 25 years against failure of frame, sash and mullions. Failure modes include: warping, cracking, shrunken glazing beads, failure of gaskets, dislocation or disappearance of weatherstrips, detectable water penetration through joints in the product, and operational difficulties such as inability or increased difficulty to operate products, including an increase in operating force beyond the values in AAMA/WDMA/CSA 101/I.S.2/A440 Table 6.
- .3 Hardware to have a minimum warranty period for 10 years against breakage; premature wear and/or operational difficulties such as inability or increased difficulty to operate products, including an increase in operating force beyond the values in AAMA/WDMA/CSA 101/I.S.2/A440 Table 6.
- .4 Unpainted frames shall be free of uneven or noticeable colour change for a period of 10 years. Painted finishes shall be free of noticeable uneven or noticeable colour change for a period of 10 years.

## 2 Products

- .1 **ALL FENESTRATION ASSEMBLIES:** All fenestration products shall conform to all applicable provisions of AAMA/WDMA/CSA 101/I.S.2/A440 and CSA A440S1, including material and component quality requirements and specifications.
  - .1 Window Operation – awning or casement sashes are required. Sliding windows will be considered in certain applications (for example, on existing buildings in areas where awning or casement windows will result in a hazardous obstruction on exterior walkways, need to meet egress or where large overhangs protect the slider).
  - .2 Forced entry resistance to comply with AAMA/WDMA/CSA 101/I.S.2/A440.
  - .3 The operating hardware type, operating force and handle location shall be determined by the Design Consultant so as to be appropriate for the needs and abilities of the building occupants. Accessible door hardware type and handle location shall be determined by the Design Consultant.
  - .4 All exterior entry, accessible side hinged and sliding doors exposed to driving rain shall be protected and have a minimum water resistance rating of Limited Water (LW). Doors that are not protected to achieve the water rating specified for windows. Design Consultant to detail the door installation in a way that accommodates accessibility and water tightness without compromising specified performance requirements, by recessing the door into the floor if necessary. When this is not possible accessible doors shall be provided with sufficient roof overhang protection to protect the door sills from driving rain. The overhang depth must be sufficient to ensure a Low Exposure condition at the door sill using Rain Exposure Nomographs

based on those in CSA A440.4, such as those published in the guide, "Best Practices for Replacing Windows and Doors in Wood Frame Buildings", published by HPO.

- .5 If required by the Owner, provide screens on operable fenestration products. Screens shall be glass-fibre mesh in an aluminum frame, finished to match frame colour. Screens must be tested to comply with Clause 5.1 of CSA A440S1. Screens must not interfere with operation of window hardware.
- .6 Machine all joints, corners, miters accurately to ensure flush hairline joints. Vinyl framed products to have welded frame corners.

## .2 GLASS AND GLAZING

- .1 Design glass strength to CAN/CGSB 12.20. Heat strengthened and tempered glass to conform to CAN/CGSB 12.1.
- .2 Insulating glass units shall be of dual seal construction certified for durability and argon gas retention to ASTM E 2190.
- .3 Low-E coating, edge spacer, and gas fill to be in accordance with labeled fenestration product labeled energy performance.
- .4 Install insulating glass units in accordance with IGMA TM-3000.
- .5 The use of safety glass to be per the current BCBC and is to be identified by the Engineer of Record that is signing and sealing the shop drawings and providing letter of assurance for the windows and doors.

## .3 SEALANTS

Refer to [Division 07 92 00 - Joint Sealants](#); use two-part urethane to exterior and one-part urethane to interior.

## .4 CRITICAL BARRIERS

Ensure continuity of critical barriers (water shedding surface, water resistive barrier, air barrier, vapour retarder) at interface between fenestration products and walls.

## .5 FINISHES

Factory applied coatings shall conform to the following specifications referenced in AAMA/WDMA/CSA 101/I.S.2/A440:

- .1 AAMA 611 Voluntary Specification for Anodized Architectural Aluminum
- .2 AAMA 612 Voluntary Specification, Performance Requirements, and Test Procedures for Combined Coatings of Anodic Oxide and Transparent Organic Coatings on Architectural Aluminum
- .3 AAMA 613 Voluntary Performance Requirements and Test Procedures for Organic Coatings on Plastic Profiles
- .4 AAMA 623 Voluntary Specification, Performance Requirements and Test Procedures for

Organic Coatings on Fiber Reinforced Thermoset Profiles

- .5 AAMA 2603 Voluntary Specification, Performance Requirements and Test Procedures for Pigmented Organic Coatings on Aluminum Extrusions and Panels

## .6 FLASHINGS

- .1 24 gauge minimum base metal thickness, Z275 designation, zinc-coated steel conforming to ASTM A652/A652M, Grade A, prefinished to match window frames.

# 3 Execution

- .1 Install fenestration products in accordance with CAN/CSA-A440.4.
- .2 Installation must comply with contract documents, reviewed shop drawings and approved window mock-up.
- .3 Make sure the window product and installation detail maintains the continuity on thermal protection, air barrier and overall building envelope.
- .4 For renovations the Contractor is to verify window sizes by on-site measurement, allowing for installation clearances and tolerance for thermal movement. Refer to HPO publication, Best Practices for Window and Door Replacement in Wood Frame Buildings.
- .5 Seal anchor penetrations through framing members with sealant.
- .6 Correctly locate and install flashings, deflectors and weep holes to ensure proper drainage of moisture to exterior. Provide flashing with end dams over window heads and sill flashing with end dams at window sills. Slope sills and sill flashing to the outside.
- .7 Do not block or seal fenestration product weep holes.
- .8 Ensure that sealants are appropriate for the particular application; ensure proper surface preparation. Avoid any discontinuity in sealant application.
- .9 Ensure proper fit, sizing and continuity of gaskets and glazing tapes.
- .10 Adjust all hardware for proper functioning and ease of operation. Apply temporary protective plastic film coating to finished surfaces. Remove coating prior to substantial performance of the work. Do not use coating that will become hard to remove or leave residue.

End of Section

# 08 70 00 - Finish Hardware

## 1 General

- .1 Submit a detailed finish hardware schedule prepared by an Architectural Hardware Consultant (AHC) showing each separate type of item including make, model, material, function, size, finish, and other pertinent information.
- .2 Provide two (2) copies of maintenance data, manufacturer's parts list, manufacturer's instructions for door closers, lock and latch sets, door holders, panic hardware, and three (3) sets of wrenches for door closers, lock and latch sets.
- .3 Deliver tagged and indexed keys and key cylinders directly to Owner and obtain a signed receipt from Owner's authorized receiver.
- .4 Provide a one (1) year guarantee for all finish hardware except for exit devices which must have a five (5) year guarantee, closers with twenty five (25) years, locksets with five (5) years.
- .5 Alternatives to the recommended products can be accepted if it is demonstrated that the alternatives meet the minimum requirements, and are accepted by BC Housing.
- .6 The design team must consult with the Owner and building maintenance before considering the products in the building.
- .7 Consider using materials that are sourced locally.

## 2 Products

- .1 Deadbolts/Locks/Latchsets: Minimum requirements – ANSI A156.2 Series 4000 Grade 1 c/w mortised faceplate bolt/latch and 6 pin cylinders. Approved deadbolts, locks, latch set series, and designs are as follows. Any alternatives should be approved by BC Housing prior installation.
  - .1 **Exterior Doors**
    - .1 Schlage D Series Rhodes levers or Dorex G1L (required for Directly Managed buildings)
    - .2 Sargent 10 Line L levers
    - .3 Corbin CL 3500 NZD levers
  - .2 **Unit Entry Doors**
    - .1 Schlage B660 Deadbolts x D Series Rhodes lever/L series O6 Lever or Dorex G1L (required for Directly Managed buildings)
    - .2 Sargent 485 Deadbolt x 10 Series L lever/8200 series

- .3 Corbin DL 3100 Series x CL 3500 NZD lever/ ML2000 series

### **.3 Interior/Public Corridors/Common Utility/Service Doors**

- .1 Schlage D Series Rhodes levers or Dorex G1L (required for Directly Managed buildings)
- .2 Sargent 10 Series L lever
- .3 Corbin CL 3500 NZD levers

### **.4 Interior Doors Within Units**

- .1 Schlage F Series Elan levers
- .2 Sargent 3 Series L lever
- .3 Corbin CL3720 NZD

- .5 Lever handles are required on all lock and latch sets accessible to tenants.

### **.6 Exterior Doors or Gate Hardware**

- .1 Hardware for exterior doors or gates shall have stainless steel finish and corrosion resistant parts when exposed to weather.

## **.2 EXIT DEVICES**

All Exit Devices must be ULC listed for Accident Hazard and Fire Exit, and must be tested in accordance to ANSI A156.3, Grade 1.

- .1 Von Duprin 99 Series x 992L-06 trim (required for Directly Managed buildings)
- .2 Sargent 8000 Series x ETL trim
- .3 Corbin ED 5000 Series x Newport trim

## **.3 CLOSERS**

Minimum requirements: All closers must be ULC listed and certified under ANSI Standards A156.4, Grade 1. All closers to meet barrier free requirements (ADA compliant) and to provide maximum degree of opening required.

### **.1 Fire Door Closers**

- .1 LCN 1461 (recommended for Directly Managed buildings)
- .2 Sargent 1431 Series
- .3 Norton 8501 Series

### **.2 Exterior Door Closer**

- .1 LCN 4040 (recommended for Directly Managed buildings)
- .2 Sargent 351 Series
- .3 Norton 7500 Series

### .3 Swing free electronic closers (with ceiling mounted smoke detector):

If recommended by the Owner in assisted living projects for all suite entry doors and common area doors frequently used by tenants:

- .1 .1 LCN Sentronic 4310 ME
- .2 .2 Rixson Smoke Chek VI

### .4 BALL BEARING HINGES

For all fire protection rated doors, provide ball bearing hinges with five knuckles and two sets of bearings. Approved manufacturers and part numbers include:

- .1 Hager BB1279 (Ferrous Steel); Hager BB 1191 (Non-Ferrous)
- .2 Stanley BB179 (Ferrous Steel); Stanley BB 191 (Non-Ferrous)
- .3 McKinney #TA 2714 (Ferrous Steel); McKinney #TA 2314 (Non-Ferrous)

Non-Ferrous hinges shall be used on all exterior doors. Non removable pins (NRP) to be installed on doors that have hinge barrel exposed on exterior side.

### .5 HINGES – SUITE INTERIOR DOORS

- .1 89 x 89 mm (3-1/2" x 3-1/2"), 2 GD finish, 3 pair.

### .6 SLIDING POCKET DOORS

- .1 Crowderframe Type 'C' – 400 track assembly (use privacy or passage set as applicable)
- .2 Pemko PF Series or approved equivalent.
- .3 Pocket doors should be equipped with heavy gauge "D" handles with back to back mounting for ease of operation and durability. Add stopper to prevent crashing.

### .7 LABELED DOORS

Hardware used in fire rated openings must bear ULC label.

### .8 ACCESSORIES:

#### .1 Door Stops

- .1 Wall mounted convex/concave dome stop with concealed mounting. Gallery Hardware Wall #231 Convex; Wall #233 Concave or approved equal.
- .2 Floor mounted half dome rubber stop with concealed mounting. Gallery Hardware Floor #200 Lo Rise; Floor #218 High Rise or approved equal.
- .3 Provide solid backing for door stops.

#### .2 Door Viewer (peep holes)

Viewing hole to be provided at standard height 1626 mm (5'-4") and at accessible height **between the range of 1000 mm and 1200 mm from the floor**. View hole to have 180 degree viewing area

and ULC rated.

**.3 Kick Plates (For wheelchair accessible units only)**

Minimum 254 mm (10") high, full width of door, 1.6 mm (1/16") thick, aluminum C-28 finish or stainless steel C-32D finish, secured with corrosion resistant screws. Considerations should be given to install kick plates for senior units.

**.4 Push Plates**

102 mm x 580 mm, 1.6 mm thick (4" x 20" x 1/16"), aluminum C-28 finish or stainless steel C-32D finish.

**.5 Pull Plates**

Same as push plates, with 305 mm (12") "D" handles.

**.6 Door Pulls for Pocket Doors, Cabinets, and Closets**

Should be easily graspable by people with limited dexterity; minimum 102 mm (4") D pulls. No pulls on inactive cabinet doors or drawers.

**.7 Thresholds**

Extruded aluminum, mill finish, bevelled, with no more than 13 mm (1/2") floor offset, barrier-free. Set on two continuous beads of sealant and secure with at least three corrosion resistant fasteners.

**.8 Weatherstripping**

Heavy duty bulb type extruded closed cell sponge neoprene clear anodized finish weatherstrips (not foam type). Weatherstripping must restrict air infiltration to not more than 0.05 m<sup>3</sup> (1.76 ft<sup>3</sup>) per minute per 1.0 m (3'-4") of joint.

For residential doors, insert rabbit style door weatherstripping. It should have a nylon cover to prevent sticking to the slab in frosty conditions.

For out-swinging doors, insert door top and use overhead rain drip cap where door will be subjected to severe weather conditions. For interior doors use self adhesive for smoke/sound seal.

**.9** All exterior doors should be equipped with heavy gauge steel 2-piece interlocking astragals for additional security.

**.10** All sliding patio doors are required to have toe locks.

**.9 KEYING**

**.1** All locks to be supplied with a 6 pin factory generated masterkey system. Keying to be determined in consultation with architect and Owner.

**.2** All locks to operate on two common masterkeys, one master that opens all suite doors and a separate master that opens all common area and service room doors.

**.3** Allow for factory construction keying of all locks. Provide future codes for all keys.

**.4** Allow for five keys per lock (unless specified otherwise)

**.5** Except suite entry keys, all keys to be stamped "Do Not Duplicate"

**.10 FINISH**

Generally BHMA 626 Satin Chromium, unless otherwise noted.

Door Closers: sprayed aluminum (BHMA 689 finish) , unless otherwise noted.

All finishes, on hardware of like kind, shall match throughout the project. Finishes shall be #626 Satin Chromium, #630 Satin Stainless Steel, #628 Anodized Satin Aluminum, or powder coated #689 Aluminum.

**.11 SCHEDULE**

Provide finish hardware schedule as follows:

SCHEDULE OF FINISH HARDWARE   DIVISION: 08710										
Finish Hardware	Threshold	Three Ball Bearing Butts	Deadlock	Latchset	Exit Device	Door Stop	Door Sweep	Weather-stripping	Door Closure	Push Plate/ Pull Handle/ Kick Plate
Exterior Out-swing Doors	•	•	•	•	•	•	•	•	•	
Building Entrance (Power Operated Door Opener)	•	•					•	•	•	•
Suite Entry Doors	•	•	•	•		•			•	
Patio Doors		•	•	•				•		
Unit Interior Doors		•	•	•		•				
Service Room Doors		•		•			•		•	
Public Rooms and Corridors		•		•	•				•	•
Stairwells		•	•	•	•				•	•

## NOTES:

- (1) Building Entrance and accessible unit entry door: wheelchair accessible threshold
- (2) Building Entrance: closer with 90 degree hold-open arm with cards readers & electric strikes where required, no hold open
- (3) Suite entry Doors: cards readers, electric strikes and suitable locksets where required
- (4) Wheelchair Accessible Suite Entry Doors: Provide kick plates.
- (5) Deadbolt and latch go together or panic hardware and no deadbolt
- (6) Astragals required on exterior doors

## 3 Execution

- .1** Install hardware to standard hardware location dimensions in accordance with the Door & Hardware Institute Guide.
- .2** Coordinate with Electrical Sub-Contractor to provide disconnect switch located near door opening, conduit and connection of wiring to motor and connecting wiring into operator.

End of Section

# 08 71 50 - RFID Proximity Card Locking System

## 1 General

Definition: An electronic lock (or electric lock) is a locking device which operates by means of electric current. Electric locks are sometimes stand-alone with an electronic control assembly mounted directly to the lock. Electric locks may be connected to an access control system, the advantages of which include: key control, where keys can be added and removed without re-keying the lock cylinder; fine access control, where time and place are factors; and transaction logging, where activity is recorded. Electronic locks can also be remotely monitored and controlled, both to lock and unlock. Newer keycard systems use radio-frequency identification (RFID) technology

- .1** Provide an electronic locking system where specifically required by the Owner or BC Housing.
- .2** The work consists of providing a complete system design, supply and installation of a new access RFID Stand Alone Locking System.
- .3** All design and configuration activities shall be coordinated with the owner, interfacing owner's representatives and subcontractors as required.
- .4** Refer to [Division 08 70 00 - Finish Hardware](#) for door hardware coordination.
- .5** Obtain at least one complete set of the entire tender documents.
- .6** Thoroughly read through all the specifications and drawings to ensure full awareness of the scope of work, equipment to be supplied and installed, supplied to others for partial installation, or installed in other trades' work.
- .7** Ensure that all the work as specified in the specifications and drawings can be executed without changes. No extras will be considered to this contract for failure to make this examination.
- .8 SYSTEM OVERVIEW**
  - .1** Supply and install an approved RFID locking system to control exterior entrance doors, interior doors to the units, common area doors such as laundry rooms and amenity rooms, and staff office and service rooms, as required by the Owner. Supply and setup one (1) front desk unit (FDU).
  - .2** This RFID solution offers keycard auditing capabilities for enhanced staff monitoring & user accountability. The system works with both the web-based and the standalone portable Front Desk Unit (FDU).
  - .3** The locks shall include the following features:
    - .1** Cylindrical design
    - .2** High security and tamperproof design

- .3 Emergency access: Emergency keycard, mechanical key and electronic override Operates with a completely sealed contactless reader
- .4 Batteries last up to 3 years
- .5 Low battery indicator alerts staff
- .6 Lock programming and audit are not erased during battery replacement
- .7 Wear resistant construction and finish
- .8 Upgradeable lock firmware

## **.9 MECHANICAL FEATURES**

- .1 Heavy duty electronic lockset with clutch mechanism and built-in contactless RFID reader (mortise or cylindrical)
- .2 Left or right factory handed mortise, field reversible handing (lever and mortise)
- .3 Lever:
  - .1 ADA compliant, outside lever free to rotate upward and downward in locked mode
  - .2 Lever clearance (space from end of lever to door):
    - .1 Long Lever: 3/8" (9.5mm)
    - .2 Short Lever: 2" (51mm)
- .4 Concealed key override (optional)
  - .1 keyed alike, master keyed, recordable
  - .2 IC adaptor
- .5 Deadbolt – 1" (25 mm) (for ASM mortise) or 2 1.4 mm (for ESM mortise) solid metal,projected by inside thumbturn and retracted with the latch by the interior handle, emergency override or specific staff keycards. Optional auto deadbolt available
- .6 Door Thickness – from 1 3/8" to 2 1/2" (35mm to 66mm)
- .7 Housing Construction – Cast zinc alloy (outside housing levers and thumbturn), stainless steel inside housing
- .8 Standard finishes – Satin chrome, satin brass
- .9 Standard backset – 2 3/4" (70mm), 2 3/8" (60mm) backset also available for cylindrical lock

## **.10 PROGRAMMING AND AUDIT TRAIL DOWNLOADING:**

- .1 Can be done using an audit keycard or by using FRONT Desk Unit (FDU)
- .2 Keycard expiry – from 1 hour to 7 years depending on type and setup
- .3 Passage mode – set by authorized keycard
- .4 Lockout mode – set by authorized keycard
- .5 Keycards accepted – RFID cards or tags (ISO 14443, Mifare Classic (4 Byte NUID))

- .6 Feedback – “Dual sensory” audible and visible indicators
- .7 Diagnostics – Built-in battery voltage meter and lock version display
- .8 Audit Memory – Last 2000 transactions stored in lock (lock audit can be retrieved using M-unit or FDU or using lock audit keycard)
- .9 Disability Feature – Extended unlock time (4 seconds standard, 15 seconds for disability)
- .10 Privacy override – Default emergency keycard only (user selectable)

## 2 MATERIALS

### .1 RFID LOCKING SYSTEM

- .1 Approved cylindrical RFID locks with override
- .2 Allow for one (1) Front Desk Unit including software package, maintenance unit, programming cable and encoder
- .3 Allow for two hundred (200) Mifare 1K cards
- .4 Allow for twenty-five (25) Mifare 4K lock audit cards for staff

## 3 EXECUTION

### .1 STANDARDS AND PROCEDURES

- .1 All equipment and materials used will be standard components that are regularly manufactured and utilized in the manufacturer’s system.
- .2 All equipment, materials, devices and components will be installed as per the manufacturer’s installation guidelines and in accordance with all applicable standards and laws pertaining to their safe, proper and legislated installation.
- .3 All materials used must be CSA approved and installed in accordance with manufacturers’ specifications and recommendations.

### .2 WORKMANSHIP

- .1 Work shall be performed by qualified personnel certified and trained in the installation of locking systems.

### .3 RADIO FREQUENCY INTERFERENCE

- .1 Ensure that all equipment and systems are capable of operating under RFI conditions at the site.

### .4 FINAL ADJUSTMENTS, TESTING, AND COMMISSIONING

- .1 Conduct commissioning procedures as required under this Contract. Submit report of results together with all required statements and certificates.

End of Section

# 09 24 23 - Stucco

## 1 General

- .1 Materials and workmanship must conform to the *BC Building Code* and the latest edition of *Specification Standards Manual*, as published by the Association of Wall and Ceiling Contractors of British Columbia (AWCC).
- .2 Construct an on-site mockup. Mockup to show vertical control joint, cavity furring, cross cavity flashing, membrane flashing, metal flashing, building paper, stucco mesh, base and finish coats. The approved mockup may remain as a finished part of the work and will serve as a standard upon which other work will be judged.
- .3 Stucco should be designed using the drained cavity wall approach. Face-sealed stucco is only acceptable in certain geographical locations in the province as noted in the building code. The form of the building must be considered when deciding on the face-seal approach.
- .4 Stone, ceramic, powder-coated metals, plated or anodized metal, glass, concrete, clay brick and unfinished or untreated solid wood flooring must not include integral organic-based surface coatings, binders or sealants.
- .5 Paints, coatings, adhesives and sealants must not contain methylene chloride and perchloroethylene. Paints and coatings must meet Canadian Volatile Organic Compound (VOC) Concentration Limits for Architectural Coatings Regulations (SOR/2009-264). Adhesives and sealants must meet SCAQMD Rule 1168, effective July 1, 2005.

## 2 Products

### .1 STUCCO MATERIALS

- .1 Base Coat Materials shall be in accordance with AWCC *Specification Standards Manual*.
- .2 Finish Coat Materials: 100% acrylic based, factory premixed proprietary product compound with enhancements to reduce dirt pickup and staining. Owner to select the colour from manufacturer's standard ranges. Texture: Medium sandfloat finish.

### .2 BACKING MATERIALS

- .1 Metal Flashing: refer to [Division 05 50 00 - Metal Fabrications](#).
- .2 Sheathing Membrane: water repellent breather type to CGSB CAN2-51.32.
- .3 Membrane Flashing: minimum 1.0 mm (40 mil) thick sheet of self-adhering, self-healing, composite rubberized asphalt having a minimum membrane tensile strength of 177 N/25 mm (40 lb/in) to ASTM D903, and maximum permeance of 2.25 ng/Pa s m<sup>2</sup> (0.001 perms) to ASTM E96.

### .3 FURRING AND LATHING MATERIALS

- .1 Provide furring and lathing materials, including channels, furring channels, hanger and tie wire, in accordance with AWCC Specification Standards Manual.
- .2 Use paperback lath, standard type welded wire lath, expanded metal or rib lath to ASTM C841 and C847.

### .4 STUCCO ACCESSORIES

- .1 Provide all stucco accessories and/or trim such as stops (casing beads), internal corner reinforcement, weep and drip screeds, reveals, etc., as detailed on drawings and/or as required to AWCC Specification Standards Manual.
- .2 Provide accessories fabricated from hot dipped galvanized steel, zinc alloy, extruded exterior grade PVC or aluminum of types and of materials pre-approved by the design authority, and to Reference Standard.
- .3 Fasteners to CSA B111 (nails and staples) and ASTM C1002 (screws), of suitable corrosion resistant material, compatible with material, sheathing, framing or other substrate.
- .4 Fastener specifications will consider cladding weight, imposed lateral loads (wind and earthquake), strapping size and spacing, sheathing type and thickness, in addition to the various types of fasteners available.

## 3 Execution

- .1 Unless otherwise specified stucco work should not be performed when the ambient air and substrate temperatures are below 4°C (39°F) or above 38°C (100°F) for 24 hours before, during and after stucco application. Do not install materials during inclement weather unless means to protect installation are taken. Refer to the manufacturer's recommendations. Acrylic coat must be protected from moisture for a minimum of 24 hours following application.
- .2 Ensure proper cure times are achieved between base, brown and finish coat.
- .3 Ensure that stucco will fully cure by keeping it moist throughout the curing period. Additional methods of moist curing may be required to prevent cracking.
- .4 Install a horizontal cross-cavity flashing at every floor level.
- .5 All materials and ingredients should be clean and free of contamination during mixing and application. No surfactants are to be added to the stucco mix.
- .6 Provide vertical control joints at maximum 3048 mm (10'-0") intervals and in areas where there is potential for differential settlement. Control joints should extend through the lath and other accessories to eliminate restraint at the panel edges.

- .7 Vertical control joints must be sealed with non-hardening exterior type sealants as recommended by stucco manufacturer and in accordance with [Division 07 92 00 - Joint Sealants](#).
- .8 Ensure fasteners for the stucco lath are installed in an alternating pattern, on the wire, both vertically and horizontally.

End of Section

# 09 28 00 - Gypsum Wallboard

## 1 General

- .1 Materials and workmanship must conform to The Specification Standards Manual as published by the Association of Wall and Ceiling Contractors of BC (AWCC).
- .2 Finish walls within habitable areas with gypsum wallboard to receive a paint finish.
- .3 Finish ceilings with a painted drywall finish.
- .4 Specify wall, floor and ceiling assemblies in all areas of the building to achieve a minimum sound rating of STC50 or ASTC47 in accordance with the current version of BC Building Code, unless otherwise noted in BC Housing Guidelines. Specify assemblies with a minimum effective rating of STC 55 adjacent to an elevator shaft or refuse chute. Refer to BC Building Code, 9.11.1.1(1) and Appendix. Provide effective STC 55 for TV room and machinery areas adjacent to residential rooms, plumbing within party walls, Refer to [Section 1 General Design Guidelines](#).
- .5 Consider using materials that are sourced locally and have high recycled content. Select low emitting materials and products.
- .6 Where fire and sound rated gypsum wallboard assemblies are required, construct to applicable BC Building Code, NBC, ULC, WHI or other pre-approved testing agency construction details pertaining to the assembly.  
  
The Consultant should note, in the assembly schedule, the number of the rated assembly and the authority or agency responsible for the rating.
- .7 Paints, coatings, adhesives and sealants must not contain methylene chloride and perchloroethylene. Paints and coatings must meet Canadian Volatile Organic Compound (VOC) Concentration Limits for Architectural Coatings Regulations (SOR/2009-264). Adhesives and sealants must meet SCAQMD Rule 1168, effective July 1, 2005.

## 2 Products

### .1 GYPSUM BOARDS

- .1 Standard Gypsum Board: to ASTM C1396/C1396M, 12.7 mm (1/2") and 15.9 mm (5/8") thick, dimensions 1.219m (48") x maximum practical length to minimize joints.
- .2 Fire-resistant Gypsum Board: Fire-resistant Type X having ULC label and/or Type C to ASTM C1396/C1396M, 12.7 mm (1/2") and 15.9 mm (5/8") thick.
- .3 Mould and Moisture Resistant Gypsum Board: to ASTM C1658, 12.7 mm (1/2") and 15.9 mm (5/8") thick Type X, coated inorganic fiberglass mat facer front and back with enhanced

moisture and mould resistance core. Score 10 for mould resistance as per ASTM D3273 dimensions 1.219m (48") x maximum practical length to minimize joints.

- .4 Water-resistant Gypsum Tile Backer Board: to ASTM C1178, 12.7 mm (1/2") thick standard and/or 15.9 mm (5/8") thick, Type X, water resistant board with enhanced moisture and mould resistant gypsum core and faces bonded to an inorganic fibreglass mat wrapping treated with one face coated with a heat cured copolymer water and vapour retardant coating.
- .5 Cementitious Tile Backer Board: to ASTM C1325, asbestos and formaldehyde free, non-combustible composite board of Portland cement, ground sand, cellulose fibre, selected additives and water, thickness and length to suit for ceramic tile shower/tub surround. For bed bug room use cementitious backer board with thickness 13 mm (1/2"), width 915 mm (36"), length maximum practical for minimum joints.
- .6 Glass-Mat Gypsum Sheathing Board: to ASTM C1177, 12.7 mm (1/2") thick standard and/ or 15.9 mm (5/8") thick, Type X, water resistant board with enhanced moisture and mould resistant gypsum core and coated inorganic fiberglass mat facers front and back for exterior sheathing. Score 10 for mould resistance as per ASTM D3273.

## .2 ABUSE-RESISTANT WALLBOARD

- .1 Abuse Resistant Gypsum Board: to ASTM C1629, Type X, thickness 12.7 mm (1/2"), or 15.9 mm (5/8"), dimensions 1.219 m (48") x maximum practical length to minimize joints for use in lieu of standard drywall to protect from high damage areas for the buildings with hard to house tenants, if required. This requires BC Housing consultation. Where additional protection is required use vinyl wall protection systems, corner guards; refer to [Division 10 00 00 - Specialities](#).
- .2 Moisture, Mould and Abuse Resistant Board: to ASTM C1658, 15.9 mm (5/8") thick Type X, heavy duty coated inorganic fiberglass mat facer front and back with enhanced moisture and mould resistant gypsum core. Score 10 for mould resistance as per ASTM D3273, level 3 for surface abrasion, level 1 for indentation resistance and level 1 for soft body impact, and level 1 for hard body impact as per ASTM C1629.

## .3 ACCESSORIES

- .1 Fasteners: use self drilling drywall screws for fastening gypsum wallboard in accordance with AWCC Manual. Use corrosion resistant screws for fastening cementitious/water-resistant gypsum tile backer board.
- .2 Corner Bead: use tape-on corners with an abrasion resistant finish.
- .3 Tape: for gypsum board tape use 50.8 mm (2") spark perforated paper tape, for cementitious board type use 50.8 mm (2") wide alkali-resistant fibre glass tape or type as recommended by the manufacturer.
- .4 Joining compound: for gypsum board use vinyl or latex base, slow setting, for cementitious board use pre-sanded dry thin-set or latex Portland cement mortar or as recommended by the manufacturer.
- .5 Acoustical Sealant: in accordance with [Division 07 92 00 - Joint Sealants](#).
- .6 Thermal and Acoustic Insulation: in accordance with [Division 07 21 00 - Thermal Protection](#).

- .7 Fiberglass Reinforced Panels (FRP): for all exposed building walls in a commercial kitchen, and the wall behind urinals in a common washroom for homeless at-risk or shelter projects.

## 3 Execution

- .1 Application of gypsum wallboard shall comply with AWCC Specification Standards, Section 9.5, Part 3.
- .2 Allow deflection spaces between gypsum board partitions and building structural framing components to allow movement of framing components.
- .3 Make sure the area temperature is acceptable for execution; specially due to seasonal variations in interior/northern region. Do not close in ceiling and soffit spaces or walls until all services have been completed, tested and approved.
- .4 Seal underside of wood stud plates with acoustical sealant in accordance with [Division 07 92 00 - Joint Sealants](#), and as required by the specifications for the rated assembly. Seal around all penetrations in walls including joints between dissimilar constructions.
- .5 To prevent insects and bed bugs from getting behind the baseboard and wall, place a continuous full bead of sealant along the joint between the drywall/wall sheathing and the floor finish. After installation of the wood baseboard, install provide a continuous full bead of sealant along the joint between the floor finish and the baseboard and at the top edge of the baseboard.
- .6 All penetrations for electrical, cable, and plumbing shall be properly seals to maintain air tightness within the space.
- .7 Provide a prefinished PVC "J" bead at window/gypsum board junctions.
- .8 Provide fire extinguishers in recessed enclosures in corridor walls. User functions of fire extinguisher cabinets shall be installed at accessible height, e.g., not more than 1220 mm (4'-0") above the floor. Do not compromise required fire separation or rating.
- .9 Behind one-piece plastic laminate tub surround use moisture resistant gypsum wallboard.
- .10 Finish gypsum wallboard surfaces in accordance with the Levels of Finish as prescribed in Section 9.5 of the AWCC Manual and as follows:
  - .1 Level 1 Finish: use this finish in areas where the assembly will be completely concealed from view such as in ceiling spaces and behind solid wall and ceiling finishes.
  - .2 Level 2 Finish: use storage and service areas.
  - .3 Level 3 Finish: use this finish in areas that will receive additional wall covering.
  - .4 Level 4 Finish: use this finish in areas that will receive a GL1, GL3 and GL5 paint finish.

- .11** Refer to [Appendix B-Reducing Air Leakage between Suites](#) to minimize air leakage and bed bug migration between units.

End of Section

# 09 30 00 - Ceramic Tile

## 1 General

- .1 Furnish labour, materials, and equipment for the complete supply and installation of all ceramic wall and floor tile, to areas and surfaces as shown.
- .2 Low VOC limit for adhesives. Consider using locally available materials with recycled content.
- .3 Stone, ceramic, powder-coated metals, plated or anodized metal, glass, concrete, clay brick and unfinished or untreated solid wood flooring must not include integral organic-based surface coatings, binders or sealants.
- .4 Paints, coatings, adhesives and sealants must not contain methylene chloride and perchloroethylene. Paints and coatings must meet Canadian Volatile Organic Compound (VOC) Concentration Limits for Architectural Coatings Regulations (SOR/2009-264). Adhesives and sealants must meet SCAQMD Rule 1168, effective July 1, 2005.

### .5 QUALITY ASSURANCE

All tile work in accordance with recommendations as set out in the latest edition of the Tile Specification Guide 09300 Tile Installation Manual as prepared by the Terrazzo, Tile and Marble Association of Canada (TTMAC) and to ANSI 108.1 & 108.5.

### .6 SUBMITTALS

- .1 Provide Owner with cleaning and maintenance instructions for tile and grouts used upon completion of the work.
- .2 Provide the Owner with a minimum of 2% of each type and colour of tile used in the work for Owner's later use or maintenance.

## 2 Products

### .1 MATERIALS

- .1 Cement: Type 10 Portland Cement conforming to CAN/CSA-A3000, A5 colour grey.
- .2 Sand: Conforming to ASTM C144 passing 16 mesh.
- .3 Water: Fresh, clean, potable, free from deleterious matter, acids or alkalis.
- .4 Latex Additive: Enriched latex emulsion additive conforming to ANSI A118.4 for use in thin set mortar.
- .5 Shower Base Waterproof Membrane:

Provide pre-manufactured sheet, liquid applied or trowelled membrane as required by applicable codes and authority having jurisdiction.

The Plumbing Officials Association of BC (POABC) allows above, below or on grade installations. Liquid & trowelled membrane applications must meet ANSI 118.10 for waterproofing and confirm manufacturer's instructions and TTMAC requirements.

- .6 Backer Board: Minimum 13 mm Cementitious backed board (ANSI A118.9), nominal 11mm Fibre-Cement baker board (ASTM C1288) or 13mm (1/2") Coated glass mat baker board (ASTM C1178) according to TTMAC requirements.
- .7 Reinforcing Mesh: All flooring incorporating a mortar bed and waterproof membrane. Reinforcing mesh, as per TTMAC detail 309F, to be 51 mm x 51 mm (2" x 2") 16 gauge galvanized welded wire mesh.
- .8 Wall Tile Edge Trim: Extruded aluminum trim for use at exposed washroom wall tile edges.
- .9 Floor Tile Edge/Transition Trim: Extruded aluminum trim at all exposed floor tile edges.

## .2 TILE

- .1 Conform to CAN/CGSB-75.1 – M complete with cushioned and bull nosed edges and necessary shapes as required. Provide floor tile with matching coved base and internal and external corners.
- .2 All ceramic used at floor areas to meet dynamic co-efficient of friction of 0.42 in accordance with ANSI A137.1 standards.

The following tiles are suggested according to TTMAC ceramic tile type, finish and water absorption percentage by mass:

MATERIAL	TYPE/DIMENSIONS/STYLE	MR RATING	FINISH
<b>Ceramic Tile WC Wall</b>	Type 5 / Ceramic wall tile	MR 4	Matt or glazed finish
<b>Ceramic Tile Shower Walls</b>	Type 5 / Ceramic wall tile	MR 4	Glazed-finish
<b>Ceramic Tile Shower Floor/ Cove Base</b>	Type 2 / Porcelain mosaic tile	MR 1	Matt finish
<b>Ceramic Tile Lobby Floors and High Traffic Areas</b>	Type 4 / Porcelain tile with matching RE & RX fittings	MR 2	Matt or unglazed For Matt finish PEI rating should be 5 or above

## .3 MIXES

- .1 Thin Set Mortar: requirement must meet ANSI 118.4 and ANSI 118.11 which can be single component (polymer modified) or two component (liquid latex modified).
- .2 Mortar Bed: a mixture of 1 part Portland cement, 4 parts sand and latex additive where required by TTMAC detail. Premixed mortar may be used per manufacturer's instructions and may need to adjust water volume depending on moisture content of sand.
- .3 Polymer Modified Grout: requirement must meet ANSI 118.7.

# 3 Execution

## .1 INSTALLATION

### .1 Thin Set Method:

- .1 **Shower Walls:** TTMAC detail 305W A & B; allow for a levelling coat to plumb water resistant cementitious backing board, concrete block and surfaces to receive tile; tape joints of backer board with fibreglass mesh set into acrylic modified mortar bed. Apply mortar; minimum 5 mm (3/16") thick.
- .2 **Floor Areas & Base:** Dry areas; TTMAC detail 311F - A; use thin set mortar bed on concrete floor surfaces; all tile to be fully back buttered with latex modified mortar for a full mortar bed without hollows or non-bonded ceramic tile areas. Level tile joints for even surface. Provide divider strips and edge trim at termination of tile floor to other surface. Divider strips and edge trim to have top width of 3 mm (1/8").

### .2 Mortar Bed (Shower floor areas)

- .1 Install ceramic tile according to the TTMAC details similar to 309F using a cleavage membrane/reinforced mortar bed and bond coat.
- .2 Provide mortar bed over cleavage membrane and install galvanized reinforcing mesh. Set mortar bed thickness as required so that floor finish elevation to top of ceramic tile will match adjacent finish floor elevations.
- .3 Install the ceramic tile to mortar bed using an acrylic modified bond coat.
- .4 In shower areas, install waterproof membrane below tile mortar bed in accordance with manufacturer's directions and slope to drain as indicated. Install floor tile in accordance with TTMAC Detail No. 319SR - A & B using reinforced mortar bed and bond coat.

End of Section

# 09 65 00 - Resilient Flooring

## 1 General

- .1 Workmanship and materials must conform to the Specification Manual as published by the National Floor Covering Association (NFCA), Canadian General Standards Board (CGSB), and the BC Floor Covering Association (BCFCA), latest edition.
- .2 Select low VOC limit products and adhesives. Consider using materials that are sourced locally and have high recycled content. Paints, coatings, adhesives and sealants must not contain methylene chloride and perchloroethylene. Paints and coatings must meet Canadian Volatile Organic Compound (VOC) Concentration Limits for Architectural Coatings Regulations (SOR/2009-264). Adhesives and sealants must meet SCAQMD Rule 1168, effective July 1, 2005.
- .3 If a program exists on the recyclability of the products after the useful service life, preference should be given to that Manufacturer's products.
- .4 The long term maintenance of the products must be considered. It is required to have a very low maintenance floor product, with a long life expectancy and no wax finishes required while maintaining an even luster for the life of the product.
- .5 Provide resilient flooring based on the following general areas:
  - .1 **Tenant Suites**
    - .1 Bathrooms/Wheel in bathroom/shower – Slip resistant sheet vinyl for bathrooms with painted 89mm x 17mm (3.5" x 0.67") wood base. **For homeless at-risk and shelter projects, provide slip resistant sheet vinyl with integral or flash cove base.**
    - .2 Dining/Living Room/Bedroom – Homogeneous or heterogeneous sheet vinyl with painted 89mm x 17mm (3.5" x 0.67") wood base.
    - .3 Kitchen – Homogeneous or heterogeneous sheet vinyl with painted 89mm x 17mm (3.5" x 0.6") wood base.
  - .2 **Tenant Common Areas**
    - .1 Amenity areas, Activity & Lounge – Homogeneous sheet vinyl or linoleum sheet with painted 140mm x 17mm (5.5" x 0.67") wood base.
    - .2 Commercial Kitchen **and Storage Pantry** – Slip resistant sheet vinyl for commercial kitchen with integral cove base.
    - .3 Common Dining Area – **Slip resistant sheet vinyl** or linoleum sheet with painted 140mm x 17mm (5.5" x 0.67") wood base.
    - .4 Elevator Cab –Textured sheet rubber flooring.
    - .5 Laundry – Homogeneous sheet vinyl flooring with integral or flash cove base.

- .6 Corridor – Homogeneous sheet vinyl or linoleum sheet with painted 40mm x 17mm (5.5" x 0.67") wood base.
  - .7 Common Washrooms - Slip-resistant sheet vinyl with integral flash cove base.
  - .8 Janitorial Closet -Slip resistant sheet vinyl with integral cove base.
- .3 Support Areas**
- .1 Office Areas – Heterogeneous sheet vinyl or homogeneous sheet vinyl with painted 40mm x 17mm (5.5" x 0.67") wood base.
  - .2 Utility/Service Areas - Homogeneous sheet vinyl with painted 64 mm (2-1/2") wood base or finish paint on concrete..
- .6** Provide a minimum of five percent of each type and colour of resilient floor covering supplied, for the Owner's maintenance requirements. Neatly package, mark and leave on site in a location as directed by the Consultant.
- .7** Submit samples of all resilient flooring, accessories and seam layout to Consultant and Owner for review prior to installation.
- .8** Consideration should be given to have an independent third party inspection services for quality assurance at several stages while executing floor installation.

## 2 Products

### .1 EXIT STAIRS – CONCRETE CONSTRUCTION

- .1 Tread, Riser and Landing: Concrete finish to be provided. See [Division 03 30 00 - Cast-in Place Concrete](#).
- .2 Tactile Warning Strip: Tactile Warning Strip by Johnsonite, or grooves in concrete surface, or approved alternate; size, colour and location as per applicable building code requirements.

### .2 EXIT STAIRS – WOOD FRAMED CONSTRUCTION

- .1 Tread, Riser and Landing: **For the visually impaired, provide a** raised profile rubber stair tread with 140mm (5.5") base (riser) or Homogeneous sheet vinyl tread and riser with 2.0 mm (0.080") thickness.
- .2 Nosing: **For the visually impaired, provide a nosing with an appropriate profile, textured, and high colour contrast to tread, riser, and landing.**
- .3 Tactile Warning Strip: Different colour and texture than flooring; same colour as nosing; size and location as per applicable building code requirements.

- .3 FLOOR UNDERLAYMENT** Will be required where plywood subfloor is provided. See [Division 06 10 00 - Rough Carpentry](#).

#### .4 HETEROGENEOUS SHEET VINYL

- .1 Standard: ASTM 1303, Standard Specification for Sheet Vinyl Floor Covering with Backing, Type 1, Grade 1, Class B.
- .2 Type: Binder Content 90% minimum.
- .3 Wear Layer Minimum Thickness: tenant suites – minimum 0.55 mm (0.02") and support areas - minimum 0.70 mm (0.028").
- .4 Overall Thickness: minimum 2.0 mm (0.080") nominal.
- .5 Seams: All seams to be heat welded with matching welding rods.
- .6 Maintenance: no wax or polish ever needed, wash and dry buff only to maintain an even luster for the life of the products.
- .7 Acceptable products: For tenant suites Wood Collection by Altro, Eternal by Forbo and for common or support areas Ruby or Footnotes by Tarkett, Timberline by Armstrong or approved equal.

#### .5 HOMOGENEOUS SHEET VINYL

- .1 Standard: ASTM F1913, Standard Specification for Sheet Vinyl Floor Covering without Backing.
- .2 Type: Binder Content 50% minimum.
- .3 Wear Layer Minimum Thickness: minimum 2.0 mm (0.080").
- .4 Overall Thickness: minimum 2.0 mm (0.080").
- .5 Seams: All seams to be heat welded with matching welding rods.
- .6 Maintenance: no wax or polish ever needed, wash and dry buff only to maintain an even luster for the life of the products.
- .7 Abrasion Resistance (EN 660): must meet group T.
- .8 Acceptable products: iQ Granit or Optima by Tarkett or **Classic Mystique** PUR by Polyflor or approved equal.

#### .6 LINOLEUM SHEET FLOORING

- .1 Standard: ASTM F2034 Standard Specification for Sheet Linoleum Floor Covering, Type 1.
- .2 Type: Linoleum sheet with backing.
- .3 Weight: 3kg/5.5 lbs.
- .4 Overall Thickness: same colour throughout, minimum 2.5mm (0.1") overall (nominal).
- .5 Maintenance; no initial surface treatment required, maintain an even luster for the life of the products.
- .6 Products should be chosen from manufacturer's standard colour collection or range.
- .7 Acceptable Products: Forbo Marmoleum; Armstrong Marmorette, Tarkett Harmonium Veneto or alternate equal.

## **.7 RUBBER BASE**

- .1** Standard: ASTM F1861, Type TP, Group 1 (solid), Style B (Cove) Standard Specification for Resilient Wall Base.
- .2** Height: 140mm (5.5"); Thickness: 3 mm (1/8") Location: Stair Riser.

## **.8 SLIP-RESISTANT SHEET VINYL FOR BATHROOMS**

- .1** Standard: ASTM F 1303, Standard Specification for Sheet Vinyl Floor Covering with Backing, Type 2, Grade 1, Class A or B backing.  
or  
Standard: ASTM F1913, Standard Specification Sheet Vinyl Floor Covering without Backing.
- .2** Static coefficient of friction of 0.60 or greater for level surfaces and 0.80 or greater for dry ramps, ASTM D 2047.
- .3** Overall Thickness: minimum 2.0 mm (0.080").
- .4** Seams: All seams to be heat welded with matching welding rods.
- .5** Acceptable products for bathing areas for barefoot: products shall be appropriate for barefoot use: Aquarius by Altro, Multisafe or Safe-T by Tarkett, Safeguard Spa by Armstrong or approved equal.
- .6** Acceptable products for bathing areas for non-barefoot: products shall be appropriate for non-barefoot use: Aquarius by Altro, Granit Safe-T by Tarkett, Polysafe **Verona or Quattro** by Polyflor or approved equal.

## **.9 SLIP-RESISTANT SHEET VINYL FOR COMMERCIAL KITCHEN**

- .1** Standard: ASTM F 1303, Standard Specification for Sheet Vinyl Floor Covering with Backing, Type 2, Grade 1, Class A backing.
- .2** Static coefficient of friction of 0.60 or greater for level surfaces and 0.80 or greater for dry ramps, ASTM D 2047.
- .3** Overall Thickness: minimum 2.5 mm (0.10").
- .4** Seams: All seams to be heat welded with matching welding rods.
- .5** Acceptable products: Designer 25 by Altro, Polysafe **Standard 2.5** by Polyflor or approved equal.

## **.10 SLIP-RESISTANT SHEET VINYL FOR DRY RAMPS**

- .1** Standard: ASTM F 1303, Standard Specification for Sheet Vinyl Floor Covering with Backing, Type 2, Grade 1, Class A backing.
- .2** Static coefficient of friction of 0.60 or greater for level surfaces and 0.80 or greater for dry ramps, ASTM D 2047.
- .3** Overall Thickness: minimum 2.5 mm (0.1").
- .4** Seams: All seams to be heat welded with matching welding rods.
- .5** Acceptable products: Safeguard by Armstrong, Designer 25 by Altro, Polysafe Ultima by

Polyflor or approved equal.

## 3 Execution

Consultant shall ensure that specifications for environmental conditions, products, surface preparation, installation, and maintenance requirements are specified in the contract documents.

- .1** The flooring installer shall be competent in the installation of the resilient flooring products specified for the project and have "Red Seal" or "Install" certification. Installer must have 5 years of experience installing these products.
- .2** Prior to installation, the Contractor, flooring installer, flooring manufacturer's representative, independent inspection authority ( if required) and Consultant shall meet on-site to establish procedures for inspections, approval of product samples, patterns, colours and accessories, procedures for acceptability of the substrate initial cleaning, environmental conditions, installation procedures, and protection of finished work.
- .3** Install flooring wall to wall before the installation of floor-set cabinets, casework, equipment, movable partitions, etc. Extend flooring into toe spaces, door recesses, closets and similar openings as shown on drawings.
- .4** Lay flooring to provide a minimum number of seams. Avoid seams in bathrooms. Seams in kitchens are permitted only under fridges, stoves, or in closets.
- .5** Floor drains in areas finished with sheet goods should be provided with a clamping system that will ensure positive water flow and a watertight flooring installation. Sheet vinyl required in these areas.
- .6** In wheelchair accessible prefabricated shower units, the joint between the edge of the shower and the resilient floor shall be sealed with caulking and the caulking protected by transition strip, to ensure a watertight flooring installation. Exposed caulked joints are not acceptable. Contractor to prepare a mock-up to be reviewed by the Consultant.
- .7** Contractor and flooring installer should coordinate with flooring manufacturer's representative for training and mock up prior installing any products. Obtain Owner's and Consultant's acceptance or further actions/revisions if warranted.
- .8** Comply with manufacturer's product data, including product technical bulletins and installation instructions. Manufacturer's recommended adhesives must be compatible with the subfloor.
- .9** Protect all installed flooring from damage by protective coverings and remove the coverings at final cleaning.

End of Section

# 09 68 00 - Carpet

## 1 General

- .1 Workmanship and materials must conform to the Specification Standards Manual as published by the National Floor Covering Association, latest edition, Canadian General Standards Board (CGSB), and the BC Floor Covering Association (BCFA).
- .2 Low pile, interlocking level-loop or textured carpet in common areas.
- .3 Provide wood base to all areas finished in carpet.
- .4 Provide trims and accessories that will not pose a hazard to persons with mobility aids.
- .5 Submit samples of all carpet, accessories and seam layout to Consultant and Owner for review prior to installation.
- .6 Provide a minimum of five percent of each type and colour of carpet supplied, for the Owner's maintenance of floors. Neatly package, mark and leave on site in a location as directed by the Consultant.
- .7 Select low VOC limit products and adhesives. Consider using materials that are sourced locally and have high recycled content. Paints, coatings, adhesives and sealants must not contain methylene chloride and perchloroethylene. Paints and coatings must meet Canadian Volatile Organic Compound (VOC) Concentration Limits for Architectural Coatings Regulations (SOR/2009-264). Adhesives and sealants must meet SCAQMD Rule 1168, effective July 1, 2005.

## 2 Products

Only new materials are to be used, no seconds or substandard materials are to be used.

### .1 CARPET FOR COMMON AREAS AND ACCESSIBLE SUITES(GLUE DOWN METHOD)

Carpet For Common Areas and Accessible Suites: 1830 mm (6'-0"), 1980 mm (6'6") or 3660 mm (12'0") wide broadloom. Carpet for common and residential areas shall be constructed to the following minimum standards and comply with the latest CGSB Standards:

- .1 **Pile Fibre:** 100% BCF Nylon
- .2 **Construction:** Interlocking level loop or textured
- .3 **Pile Weight:** Minimum 882 g/m<sup>2</sup> (26 oz/yd<sup>2</sup>).
- .4 **Pile Height:** max. 4.0 mm (0.16")

- .5 **Machine Gauge:** 39.4 rows per 10cm (1/10)
- .6 **Stitch Count:** Minimum 46.1 stitches/10cm (11.7 spi)
- .7 **Density Factor:** Minimum 12.0 kilotex/cm<sup>2</sup>
- .8 **Pre finish Treatment:** Hot water scoured and extracted
- .9 **Colouration:** Solution dyed
- .10 **Stain Resistant:** Min. 8.0 AATCC 175
- .11 **Ravel Test Performance:** Must prevent ravelling when tested to PTL-CR (center ravel) and PTL-ER (edge ravel) protocols
- .12 **Flammability:** CGSB 4 GP 129
- .13 **Static Generation:** Maximum 3.5kV under AATCC Method 134
- .14 **Light Fastness:** Min. L5
- .15 **Resistance to Change on Wet Cleaning:** Grey Scale 5 to AATCC 16E
- .16 **Indoor Air Quality:** CCI/CRI Green Label Plus requirement
- .17 **Primary Backing:** Woven polypropylene
- .18 **Secondary Backing:** Woven Synthetic
- .19 **Anti-microbial:** Contact inhibition of fungal and bacterial growth tested according to AATCC methods 30 & 147.
- .20 **Recycling Program:** Eligible for recycling program.

## .2 CARPET FOR RESIDENTIAL AREAS (STRETCH-IN METHOD, NON-GLUE DOWN)

Carpet for residential areas, shall be constructed to the following minimum standards and comply with the latest CGSB Standards.

- .1 **Fibre:** Min. 70% Polypropylene / Olefin
- .2 **Colouration:** Solid: Min. 60%. Multi Coloured: Min. 30%
- .3 **Construction:** Loop, Twisted Cable min. 70%. Air Entangled min. 20%
- .4 **Stitches:** min 7.0 spi / 27.6 per 10 cm
- .5 **Pile Weight:** min. 24 oz/yd<sup>2</sup> 814 g/m<sup>2</sup>
- .6 **Pile Height:** max. 0.28"/0.12" 7mm/3mm
- .7 **Gauge:** 1/8" / 31.5 rows per 10 cm
- .8 **Flame Resistant:** CGSB 4-GP-161
- .9 **Density:** 4800 / 6.1 Kilotex/cm<sup>2</sup>
- .10 **Primary Backing:** Woven polypropylene

- .11 **Secondary Backing:** Woven Synthetic
- .12 **Static Control:** max. 3.5 kv (AATCC 134)
- .13 **Anti-Soil Treatment:** Hot watered scoured and extracted
- .14 **Stain Resistance:** Min. 8.0 AATCC 175
- .15 **Wear & Anti-Zipper:** 10 year manufacturer's warranty
- .16 **Stain Resistant:** 10 year manufacturer's warranty
- .17 **Edge Ravelling:** 10 year manufacturer's warranty
- .18 **Indoor Air Quality:** CCI/CRI Green Label Plus requirements
- .19 **Recycling Program:** Eligible for recycling program

### .3 UNDERPAD: BONDED POLYURETHANE FOAM

- .1 **Type:** Chemically rebonded polyurethane foam
- .2 **Thickness:** max. 9.0 mm (3/8")
- .3 **Weight:** 8 lb/ft<sup>3</sup> or 128.1 kg/m<sup>3</sup>
- .4 **CGSB:** Passes 20-GP-23 M as Type 2
- .5 **Guarantee:** 10 years
- .6 **Indoor Air Quality:** CRI Green Label

## 3 Warranty

Warranty Classifications:

- Life time commercial wear warranty
- Life time zipper-lock and no edge ravel warranty
- Life time stain free warranty
- Life time anti shock warranty

### .1 DIRECT GLUE DOWN METHOD

The installation Contractor shall provide upon completion:

- A ten (10) year manufacturer's written warranty on the carpet.
- A one (1) year materials and installation guarantee from the date of Substantial Completion. This guarantee is to cover material and installation failures such as parting of seams, unravelling, or loose base.

### .2 STRETCH-IN METHOD (NON-GLUE DOWN)

The installation Contractor shall provide upon completion:

- A ten (10) year manufacturer's written warranty on the carpet which will include wear, anti-zipping, edge ravelling and anti-shock.
- A ten (10) year manufacturer's written warranty on the foam underpad.
- A one (1) year materials and installation guarantee from the date of Substantial Completion. This guarantee is to cover material and installation failures such as parting of seams, unravelling, loose base, or the re-stretching of the carpet.

## 4 Execution

- .1** All carpet must be installed in accordance with the CRI (Carpet and Rug Institute) Carpet Installation Standard.
- .2** Contractor must vacuum the existing carpet before removal and vacuum the subfloor prior to installing the new carpet.
- .3** Subfloor cracks, holes and flooring irregularities must be adequately repaired to ensure a smooth, finished appearance and to prevent accelerated wear.
- .4** To minimize wrinkling and bucking and to facilitate installation, carpet should be unrolled and allow relaxing for a minimum of 24 hours at temperature between 18-35°C.
- .5** Lay all carpet in the same direction. All pile must have the same directional fall and run as that of adjacent pieces.
- .6** Seams should be kept to a minimum and positioned as recommended:
  - .1** Do not place seams in heavy traffic areas.
  - .2** All seams must be sealed with an appropriate seam adhesive.
  - .3** Seams are not permitted perpendicular to doorways and entries. Where seams occur at corridor change of direction, follow wall line parallel to carpet direction.
  - .4** Natural light should not strike across the seam.
- .7** Cut and fit carpet for floor outlets, cover plates, and other projections. Cut openings neat, to a minimum size, and thoroughly secured around all edges. Cut carpet evenly along walls and butt tight with no raw edges showing.
- .8** Install edge strips at all intersections of carpeting with finish floors of other materials. Edge strips shall provide a smooth transition to avoid tripping hazard. Round metal edges should be avoided.
- .9** Inspect carpet closely and remove any soiled spots or excess adhesive with the proper spot remover or solvent. Remove all loose pieces of face yarn with sharp scissors.

- .10** For cushion backing use premium multi-purpose or releasable adhesive.
  
- .11** Floor traffic should be avoided for a min of 24 hrs to allow the adhesive to adequately cure and avoid rolling traffic for a min of 48 hrs. Provide protection against damage to the carpet by closing off the area or room to all unauthorized traffic or by covering the carpet with protective covering. Exposure to water from cleaning and other sources should be restricted for a min of 30 days.
  
- .12** Vacuum and clean the carpet just prior to Substantial Performance to the satisfaction of the Consultant.

End of Section

# 09 91 00 - Painting

## 1 General

### .1 DESCRIPTION

- .1 Materials, conditions, surface preparation of substrates, workmanship, quality control, protection and clean-up shall conform to requirements of the latest edition of Master Painters Institute Architectural Painting Specification Manual as issued by the local MPI Accredited Quality Assurance Association having jurisdiction (hereafter referred to as MPI).
- .2 Provide labor, materials, tools and other equipment, services and supervision required to complete all exterior and interior painting and decorating work as indicated on Finish Schedules and to the full extent of the drawings and specifications.
- .3 All materials and paints shall be lead and mercury free. Use only materials that meet the VOC limits outlined by the State of Californian South Coast Air Quality Management District's Rule 1113- Architectural Coatings.
- .4 Where indoor air quality is an issue use only MPI listed materials having a minimum E2/E3 rating based on VOC (EPA Method 24) content levels.
- .5 Consider using materials that are sourced locally and have high recycled content.

### .2 QUALITY ASSURANCE

- .1 The Paint Contractor shall have a minimum of five (5) years proven satisfactory experience and shall show proof before commencement of work that they will maintain a qualified crew of painters throughout the duration of the work.
- .2 Only qualified journeypersons who have a Tradesman Qualification Certification of Proficiency shall be engaged in painting and decorating work. Apprentices may be employed provided they work under the direct supervision of a qualified journeyperson in accordance with trade regulations.
- .3 All paint manufacturers and products used shall be as listed under the Approved Product List section of the MPI Painting Manual.
- .4 Painting and decorating work shall be inspected by a Paint Inspection Agency (inspector) acceptable to the specifying authority and the local MPI Accredited Quality Assurance Association. The painting contractor shall notify the Paint Inspection Agency a minimum of one week prior to commencement of work and provide a copy of the project painting specification, plans and elevation drawings (including pertinent details) as well as a Finish Schedule.
- .5 All surfaces requiring painting shall be inspected by the Paint Inspection Agency who shall notify the Consultant and General Contractor in writing of any defects or problems, prior to commencing painting work, or after the prime coat shows defects in the substrate.
- .6 The painting contractor shall receive written confirmation of the specific surface preparation procedures and primers used for all fabricated steel items from the fabricator/supplier to ascertain appropriate and manufacturer compatible finish coat materials to be used before painting any such work.

### **.3 REGULATORY REQUIREMENTS**

Conform to work place safety regulations and requirements of those authorities having jurisdiction for storage, mixing, application and disposal of all paint and related hazardous materials.

### **.4 GUARANTEE**

Provide and pay for either the local MPI Accredited Quality Assurance Association's two (2) year guarantee or, alternatively, a 100% two (2) year Maintenance Bond – both in accordance with MPI Painting Manual requirements. Maintenance Bond shall warrant that all painting work has been performed in accordance with MPI Painting Manual requirements.

### **.5 SUBMITTALS/MOCK-UP**

- .1** Submit consent of surety with Bid Submission as proof of ability to supply a 100% two (2) year Maintenance Bond, if an MPI Accredited Quality Assurance Association's guarantee option is not used.
- .2** Submit two sets of Material Safety Data Sheets (MSDS) prior to commencement of work for review and for posting at job site as required.
- .3** At project completion provide an itemized list complete with manufacturer, paint type and colour-coding for all colours used for Owner's later use in maintenance.
- .4** On 215 x 280 mm (8-1/2" x 11") cardstock, provide duplicate samples of each colour and material with texture to simulate actual conditions. Re-submit samples as requested by Consultant until acceptable sheen, colour and texture is achieved.
- .5** When requested by the Consultant or Paint Inspection Agency, prepare and paint a designated surface, area, room or item (in each colour scheme) to requirements specified herein, with specified paint or coating showing selected colours, gloss/sheen, textures and workmanship to MPI Painting Specification Manual standards for review and approval. When approved, surface, area, room and/or items shall become acceptable standard of finish quality and workmanship for similar on-site work.
- .6** Submit written confirmation from the product manufacturer that products is approved for use in proposed application as well as laboratory tests or data verifying product compliances with criteria specified.

### **.6 PRODUCT DELIVERY, STORAGE, AND HANDLING**

Deliver and store all painting materials in sealed, original labeled containers bearing manufacturer's name, brand name, type of paint or coating and colour designation, standard compliance, materials content as well as mixing and/or reducing and application requirements in strict accordance with manufacturer and *MPI* requirements.

### **.7 ENVIRONMENTAL, WASTE MANAGEMENT AND DISPOSAL REQUIREMENTS**

- .1** Perform no painting or decorating work when the ambient air and substrate temperatures, relative humidity, dew point and substrate moisture content is below or above requirements for both interior and exterior work.

- .2 Apply paint only to dry, clean, properly cured and adequately prepared surfaces in areas where dust is no longer generated by construction activities such that airborne particles will not affect the quality of finished surfaces.
- .3 Ensure adequate continuous ventilation and sufficient heating and lighting is in place.
- .4 Paint, stain and wood preservative finishes and related materials (thinners, solvents, caulking, empty paint cans, cleaning rags, etc.) shall be regarded as hazardous products. Recycle and dispose of same subject to regulations of applicable authorities having jurisdiction.
- .5 To reduce the amount of contaminants entering waterways, sanitary/storm drain systems or into the ground, retain cleaning water and filter out and properly dispose of sediments.
- .6 Set aside and protect surplus and uncontaminated finish materials not required by the Owner and deliver or arrange collection for verifiable re-use or re-manufacturing.

## 2 Products

### .1 MATERIALS

- .1 All materials (primers, paints, coatings, varnishes, stains, lacquers, fillers, thinners, solvents etc.) shall be in accordance with the MPI Painting Specification Manual Approved Product Listing (APL) and shall be from a single manufacturer for each system used.
- .2 Other materials such as linseed oil, shellac etc. shall be the highest quality product of an MPI listed manufacturer and shall be compatible with paint materials being used as required.

### .2 FINISH, COLOUR, GLOSS/SHEEN

- .1 Unless otherwise noted, all painting or staining work shall be in accordance with MPI Premium Grade finish requirements.
- .2 Colours shall be as selected by the Consultant from a manufacturer's full range of colours. Refer to Finish Schedule for colours identification, location and gloss level ratings from MPI Painting Manual. The schedule will be furnished after award of the Contract, except general requirements shall be as noted herein.
- .3 Colour selection will be based on five (5) base colours and three (3) accent colours with a maximum of one (1) deep or bright colour. No more than eight (8) colours will be selected for the entire project and no more than three (3) colours will be selected in each area. Note that this does not include pre-finished items by others, e.g. flashings, windows, etc.
- .4 Avoid choosing dark colours as this usually results in more lighting required.

## 3 Execution

- .1 The condition and preparation requirements for all surfaces and mixing and tinting shall be in accordance with MPI Painting Manual requirements.

- .2 Do not paint unless substrates are acceptable and/or until all environmental conditions (heating, ventilation, lighting and completion of other subtrade work) are acceptable for applications of products.
- .3 Painting coats specified are intended to cover surfaces satisfactorily when applied at proper consistency and in accordance with manufacturer's recommendations. Apply a minimum of four coats of paint where deep or bright colours are used to achieve satisfactory results.

#### .4 INTERIOR AND EXTERIOR FINISH/COATING SYSTEMS

##### Exterior

ITEM	PAINT CODE	DESCRIPTION/FINISHING SYSTEM
<b>Pavement Marking</b>	EXT 2.1A	Latex Zone/Traffic Marking
<b>Concrete Vertical Surfaces</b>	EXT 3.1A	Latex (over alkali resistant primer) G3/4 Satin
<b>Cementitious Composition Board</b>	EXT 3.3J	Latex (over alkali resistant primer) G3/4 Satin
<b>Masonry Veneer – Sealed</b>	EXT 4.1G	Water Repellent (paintable)
<b>Concrete Masonry Units</b>	EXT 4.2A	Latex (over block filler) G3/4 Satin
<b>Structural And Miscellaneous Steel</b>	EXT 5.1C	Water Based (WB) Light Industrial Coating (over alkyd primer) GL5 Semi-Gloss
<b>Galvanized Metal</b>	EXT 5.3J	WB Light Industrial Coating (over WB primer), GL5 Semi-Gloss
<b>Dimension Lumber – Painted</b>	EXT 6.2M	Latex (over latex primer) G3/4 Satin
<b>Dimension Lumber – Stained</b>	EXT 6.2B	Latex Colour Stain WB
<b>Dressed Lumber – Painted</b>	EXT 6.3J	Water Based (WB) Light Industrial (over alkyd primer), GL5 Semi-Gloss

##### Interior

ITEM	PAINT CODE	DESCRIPTION/FINISHING SYSTEM
<b>Concrete Vertical Surfaces</b>	INT 3.1C	High Performance Architectural Latex, GL3 Eggshell
<b>Concrete Horizontal Surfaces</b>	INT 3.1A	Latex Floor Enamel, Low Gloss
<b>Brick Veneer</b>	INT 4.1J	Water Repellant, Clear
<b>Concrete Block (all areas except as noted below)</b>	INT 4.2D	High Performance Architectural Latex, GL3 Eggshell
<b>Concrete Block (wet areas, service corridors, utility/service high traffic)</b>	INT 4.2D	High Performance Architectural Latex, GL5 Semi-Gloss
<b>Structural And Miscellaneous Steel</b>	INT 5.1R	High Performance Architectural Latex, GL5 Semi-Gloss
<b>Galvanized Metal</b>	INT 5.3M	High Performance Architectural Latex, GL5 Semi-Gloss
<b>Glue Laminated Beams</b>	INT 6.1R	WB Varnish, Clear (over stain) GL4 Satin
<b>Dressed Lumber – Painted</b>	INT 6.3A	High Performance Architectural Latex, GL5 Semi-Gloss

ITEM	PAINT CODE	DESCRIPTION/FINISHING SYSTEM
<b>Dressed Lumber – Stained</b>	INT 6.3W	WB Varnish, Clear (over stain) GL4 Satin
<b>Wood Paneling</b>	INT 6.4S	High Performance Architectural Latex, GL5 Semi-Gloss
<b>Gypsum Wallboard, Wall and Ceiling surfaces - Suite Bathrooms, Kitchens, Common Laundry and Washroom Areas</b>	INT 9.2B	High Performance Architectural Latex, GL5 Semi-Gloss
<b>Gypsum Wallboard – Other Areas Except As Specified Above</b>	INT 9.2B	High Performance Architectural Latex, GL Semi-Gloss GL3 for wall surfaces and GL1 Flat for ceilings

## .5 MECHANICAL/ELECTRICAL EQUIPMENT AND RELATED SURFACES

- .1 Paint exposed conduits, pipes, hangers, ductwork and other mechanical and electrical equipment with colour and texture to match adjacent surfaces, except as noted otherwise. Coordinate with mechanical trades applying banding and labeling after pipes have been painted.
- .2 Paint gas piping standard yellow where visible in service spaces.
- .3 Paint surfaces inside of ductwork where visible behind louvers, grilles and diffusers beyond sight line with primer and one coat of matte black (non-reflecting) paint. Paint the inside of light valances gloss white.

End of Section

# 10 00 00 - Specialties

## 1 General

- .1 Ensure all equipment and materials supplied to the site are installed in accordance with manufacturer's printed instructions.
- .2 This section is to be read, interpreted, and coordinated with all other divisions in [Construction Standards](#) and [General Design Guidelines](#).
- .3 Provide vandal resistant, commercial quality materials and accessories in public washrooms, mailboxes, and signage. Ensure adequate blocking and backing.
- .4 Use low VOC limit adhesives and products. Consider using local products and higher recycle contents.
- .5 Paints, coatings, adhesives and sealants must not contain methylene chloride and perchloroethylene. Paints and coatings must meet Canadian Volatile Organic Compound (VOC) Concentration Limits for Architectural Coatings Regulations (SOR/2009-264). Adhesives and sealants must meet SCAQMD Rule 1168, effective July 1, 2005.

## 2 Products

### .1 WASHROOM ACCESSORIES (COMMON AREAS AND RESIDENTIAL)

ITEM	DESCRIPTION
<b>Grab Bars</b>	Refer to Division 06100 Rough Carpentry, CSA B651 and BC Building Code, amended section 3.8 for locations and loading requirements. 30 mm (1-1/4") dia., Type 304 stainless steel, satin finish, Use concealed fasteners.
<b>Mirrors</b>	For residential units: frameless plate glass mirrors mounted with "L" shaped steel clips, with full width of the vanity, no more than 102 mm (4") above washbasin. Do not use adhesive. For public washrooms: 457 mm x 610 mm (18" x 24") aluminum frame mirror, centered over lavatory, tilt design where used in accessible washroom. Mirror shall be 6.345 mm (1/4") thick No. 1 quality polished float/plate glass with electronically applied copper and silver coatings and shall have a warranty against silver spoilage of fifteen (15) years.
<b>Paper Towel Dispenser/ Waste Disposal (common area washrooms)</b>	Surface mounted multi-fold towel dispenser fabricated of 22 gauge, satin finish with dispensing capacity minimum 350 sheets. Tumbler lock to secure hinged front panel – for public washrooms only. Wall mounted waste disposal, 30 litre (6.6 imperial gallons), enamel finish – for public washrooms only.
<b>Robe Hook</b>	Stainless steel, satin finish, flange 50mm x 50 mm (2" x 2"), projects 40 mm (1 - 5/8") from wall. Double, surface mounted, chrome finish – for residential use only.
<b>Shower Curtain Rod</b>	Type 304 stainless steel, satin finish, 50 gauge, 25 mm (1") diameter I tubing to ASTM A269 completed with mounting flanges 65 mm (2-1/2") square and nylon curtain hooks – for residential suites only.

<b>Soap Dispenser</b>	Wall mounted, fabricated of 20 gauge, satin finish stainless steel. Dispenser shall have completely concealed mounted, vandal resistant filler hole cover and sight gauge – for public washrooms only.
<b>Toilet Paper Holder</b>	Single or double roll, surface mounted, die-cast aluminum with satin finish, controlled flow delivery and lock (for common area washrooms only), mounted within 610 mm (24") of water closet. Single roll, surface mounted, satin finish stainless steel, chrome plated plastic spinner holds rolls up to 140 mm (5-1/2") dia. for residential suites.
<b>Towel Bar</b>	610 mm (24") long, chrome finish, specified to grab bar loading requirements.
<b>Sanitary Napkin Disposal</b>	Stainless steel with satin finish in each women's common washroom.

## .2 MAIL BOXES

- .1 Provide front/rear loading gang type mail boxes constructed by heavy gauge extruded aluminum doors and boxes with extruded aluminum support bars and clear anodized aluminum finish, bins 22 gauge cold-rolled steel. 5 pin tumbler key type, provide 3 keys with each lock.
- .2 Provide one mailbox per residential tenant, at least two parcel boxes and one box for office management.
- .3 Provide clear number plates (Perspex) on each compartment in accordance with suite numbering and Canada Post standards. Specify numbering sequence when ordering.
- .4 All boxes to be located not more than 1200 mm (4'-0") above the floor and minimum 610 mm (2'- 0") from the floor level, measured from center of mailbox lock.
- .5 All projects with over 100 units will require a mail room. Refer to current Canada Post Delivery Planning Standards for Builders and Developers. Submit plans to a Canada Post delivery planner for their review and approval. Coordinate supervision by Postmaster during installation.

## .3 SIGNAGE REQUIREMENTS

- .1 Provide code required signage in accordance with the requirements of BC Building Code and authorities having jurisdiction.
- .2 Locations: Building entrance, individual suites, service rooms, exit stairs, fire safety and exit route, illuminated exit signs, parking stalls, project entry road signs, direction to exit in stairwells, floor number in stairwell, public washrooms and other rooms required by Owner, BC building Code and local authorities.
- .3 All signage, exterior and interior, shall be from the same manufacturer to facilitate graphic coordination, and material and colour matching.
- .4 Signage Type:
  - .1 Exterior: Building name and civic address: Minimum letter size should be 100 mm (4") or as required by the municipality. Provide a 70% contrasting colour background. 12 mm (0.5") brushed aluminum or as specified by Owner.
  - .2 Interior: Residential room signs: individual metal room numbers on doors – 50 mm (2") brushed aluminum.
  - .3 Service rooms: 200 mm high x 200 mm wide (8" x 8"), back painted acrylic with reverse applied vinyl numbers.

- .4 Washroom signs/No Smoking signs/Fire Door Signs: dimensions and type as above, allow for handicap, male/female or gender neutral symbols (as appropriate for the project) and braille.
- .5 Stair signage/fire safety/exit route: 300 mm x 300 mm (12" x 12") with raised letters (3 mm) back painted acrylic with reverse applied vinyl letters. Coordinate with fire safety plan. Refer to [Division 26 00 00 – Electrical](#) for illuminated exit signs.
- .6 Parking lot signs: painted, allow handicap signage where required, parkade height restriction sign and alternate fuel vehicle signs.
- .7 Bed bug room signs: Refer to [Division 13 20 00 - Heat Treatment Room](#).

#### .4 CORNER GUARDS

- .1 Rigid PVC extrusions, nominal thickness of 2 mm (0.078") with matte pebble grain surface and chemical and stain resistance
- .2 Colour selection from the manufacturer's standard colour range. Lengths of corner guards shall be as detailed, complete with matching end caps.
- .3 Retainer Clips: continuous extruded aluminum complete with attachment hardware, secured at 457 mm (18") o. c. maximum.

#### .5 WALL PROTECTION:

- .1 Janitorial rooms, common washrooms behind urinals in shelter or homeless at-risk projects, and other areas with FRP panel or as indicated by the consultant, floor to ceiling, standard colour range.
- .2 Commercial Kitchen and Pantry, as required by the project, Fiberglass Reinforced Panels (FRP) at all exposed building walls and stainless steel insulated panels from the underside of the hood to the wall base. All exposed wall corners are to be protected with stainless steel corner guards.

## 3 Execution

- .1 Fasteners must be concealed wherever possible and to suit the intended use, compatible with all surfaces. Exposed fasteners must be tamperproof in common areas for supportive housing projects with homeless at-risk clients. Consult the Owner/Operator at the design stage if outlet cover plates, vents, and access hatches within suites need to be tamperproof.
- .2 Secure washroom accessories to blocking or studs in the wall. Washroom accessories must be rigid, square and flush – hollow metal to wall surface, plumb, level and in alignment with other work.
- .3 Install corner guards straight and true to lengths detailed, from top of base to manufacturer's recommendation. Do not remove protective coating until guards are installed and after final clean up.
- .4 Provide 75mm (3") high floor number at floor landing inside stairwell as described in BC Building Code article 3.8.3.13 (1) and required by authorities having jurisdiction.

- .5** Wall panels shall be installed using waterproof adhesive, vertical seams shall be minimize, top seal wall panels with bead of acrylic sealant.
- .6** All lettering at signage shall provide easy identification and maximum legibility. Unless required otherwise, signs shall be free of rough edges, irregular surfaces, non-uniform finishes, and similar imperfections.

**End of Section**

# 10 28 19 - Plastic Laminate Tub Enclosure

## 1 General

- .1 Provide prefabricated one piece plastic laminate enclosures where bathtubs are specified in suite bathrooms.
- .2 Refer to [Division 09 28 00 - Gypsum Wallboard](#), for mould and moisture resistant gypsum board behind the tub enclosures.
- .3 Consider using local products and higher recycle contents materials. Refer to [Energy and Environmental Design](#).
- .4 Paints, coatings, adhesives and sealants must not contain methylene chloride and perchloroethylene. Paints and coatings must meet Canadian Volatile Organic Compound (VOC) Concentration Limits for Architectural Coatings Regulations (SOR/2009-264). Adhesives and sealants must meet SCAQMD Rule 1168, effective July 1, 2005.

## 2 Products

- .1 Plastic Laminate: To CAN3-A172.M79 or NEMA Class I, General Purpose (GP) grade, minimum 1.2mm (0.048") thick polyvinyl chloride sheet form. Fire retardant per ASTM-D635 and UL listing under UL-94-V-O. Retain a modest gloss finish resistant to chipping, cracking, acid chemicals, stains or discoloration. Owner to select colour from manufacturer's standard range. Height: 1524 mm (5'-0") high above tub lip.
- .2 Pre-fabricated **Gelcoat** Surrounds: thermoformed, continuous cast **gelcoat** of one-piece seamless unit or tongue-and-groove interlocking panels (two or three piece if the bathroom configuration does not support one piece) to form water tight between joints and according to CAN/ULC-S102. Minimum 914 mm x 1524 mm (3' x 5') with 150mm (6") threshold for all types except accessible units. For accessible/adaptable units provide no more than 13 mm (1/2") high threshold as required by Code. Conform to recommendations of CSA B651 Accessible design for the built environment. Height: 1524 mm (5'-0") high above tub lip.
- .3 Accessories: 1.5 mm (1/16") plastic "J" cap. Colour to match plastic laminate enclosure.
- .4 Adhesives: As recommended by the manufacturer, water based
- .5 Caulking: Tub and bath caulk – silicone conforming to ASTM C920, shall be fire, water, and mildew resistant, low VOC content. [Division 07 92 00 - Joint Sealants](#).
- .6 Soap Dish: Ceramic or integral with enclosure.

# 3 Execution

## .1 FABRICATION

- .1 Factory formed enclosures. Take exact site measurements for each bathroom. Form enclosure to extend 51 mm (2") past the front face of the tub and down to floor level.

## .2 INSTALLATION

- .1 Install contact adhesive over wall substrate and to back of enclosure, let dry.
- .2 Install a construction adhesive in ribbons over contact adhesive to permit "dry" fitting of enclosure. Once placed in permanent position, press enclosure tight to wall to bond with contact adhesive.
- .3 Install backer board and solid wood blocking for future installation of grab bars. Provide 50 mm x 305 mm (2" x 12") horizontal blocking installed at 900 mm (3'-0") from the top of finish floor around the shower or bathtub. Refer to [Section 06 10 00 – Rough Carpentry](#) and [Section 09 28 00 – Gypsum Wallboard](#) for coordination.
- .4 Install "J" trim at the exposed edges of enclosure and seal with silicon sealant as specified under [Division 07 92 00 - Joint Sealants](#). Seal joint between tub lip and enclosure. Ensure seal is flexible enough to prevent cracking/un-bonding when the tub is full. Seal behind plumbing escutcheons.
- .5 Penetrations through exterior walls must be sealed to the water barrier of the wall assembly using self-adhesive bituminous membrane and/or expanding foam sealant suitably applied to protect from weather penetration. The method of sealing penetration must be acceptable to the Consultant. Provide air tightness and thermal continuity throughout the envelope.
- .6 Install ceramic soap dish with hot melt adhesive and seal around edges with silicon sealant.
- .7 Completed enclosure must fit tight to wall surfaces without hollow areas or bubbles behind enclosure.
- .8 Cleanup all excess adhesive and sealant from enclosure and adjacent surfaces.

End of Section

# 11 30 00 - Equipment

## 1 General

- .1 All appliances throughout the building in residential units shall be the same make and model, chosen from a manufacturer's regular stock run.
- .2 All appliances to be readily available from well established manufacturers and ,CSA approved and ENERGY STAR® rated ( where applicable).
- .3 Coordinate size, location, and services to appliances with kitchen cabinet manufacturer and confirm opening sizes and clearances prior to ordering equipment for all residential units including accessible and adaptable. Refer to CSA B651-04 for accessible units. Coordinate work with mechanical and electrical for location and installation of water supplies, drains, vents, and power supplies. Confirm power requirements and service capacities with affected trades.
- .4 As per [Division 01 78 00 - Closeout Submittals](#); in order to meet applicable energy incentive and rebate programs, the Contractor may be required to submit appliance invoices to BC Housing, complete with manufacturer and model numbers, unit price, and quantity. Refer to [Energy and Environmental Design](#) section.
- .5 Owner or Operator to decide what type of operation is required for the laundry equipment (e.g. coin operated, card access). **Consult Owner and/or Operator for electrical and plumbing requirements based on Owner/Operator selected equipment.**
- .6 For commercial Kitchen requirements follow current codes and requirements and the requirements of the Authority Having Jurisdiction at the time of installation including but not limited to SMACNA Guidelines for Seismic Restraint of Commercial Kitchen Equipment; Canadian Hydro Electrical Code, the Electrical Inspection Department Bulletins, the British Columbia Hydro Electric Safety Code; Canadian Gas Association, the Gas Utilization Code of the Department of Energy and Resources Management, British Columbia; BC Plumbing Code; and the Canadian Standards Association. Refer to [Article 2.2 COMMERCIAL KITCHEN REQUIREMENTS](#) in this section for **details**.

**Where food service is to be provided to the residents, the kitchen construction requirements will be determined by the use of the building, number of residents and type of cooking operations that will take place. It will also be important to confirm whether food will be prepared in the building or whether these will be prepared elsewhere and kitchen equipment in the building used primarily for reheating. Consult with BC Housing, operator, local health authority and municipalities for requirements.**

**Class 1 operation defined by City of Vancouver will produce grease laden vapors that are substantially more than what would be produced in a typical residential environment, and the requirements of NFPA 96 will apply, i.e., commercial kitchen equipment should be provided with an exhaust hood with integral fire suppression in accordance with NFPA 96.**

If commercial kitchen equipment is to be used but in a manner that will NOT produce grease laden vapors that are substantially more than what would be produced in a normal single family household environment , the requirements of NFPA 96 will not be required. If the equipment is to be used primarily for reheating food prepared elsewhere or is used occasionally for demonstration or educational purposes, then there is no expectation to comply with the requirements of NFPA 96. This is a Class 2 kitchen as defined by City of Vancouver.

For projects, where the intention is to provide residential equipment (residential range and hood), food is prepared elsewhere and brought to the building for re-heating only, and the use of the kitchen will not produce grease-laden vapours, then a Class 2 kitchen operation as defined by City of Vancouver can be considered. In that case, kitchen equipment does not need to comply with the requirements of NFPA 96.

In all cases, the design team shall consult with the local Environmental Health Office and AHJ to determine the requirements.

## 2 Products

### .1 RESIDENTIAL APPLIANCES:

ITEM	DESCRIPTION	STANDARD UNITS	WHEELCHAIR ACCESSIBLE/ ADAPTABLE UNITS
Refrigerator	<p><b>For all models:</b>                      CSA approved                      Removable and adjustable shelves                      Recessed/Integrated Door                      Reversible Swing Door                      No Water/Ice Dispenser                      LED lights                      100% Frost Free</p>	<p><b>For Single Room Occupancy (SRO) - Compact Refrigerator:</b>                      Capacity: 3.1 - 3.6 CF                      Dimensions: Max W - 22" (560 mm)                      Max H - 33 1/2" (850 mm)                      Max D - 20" (520 mm)                      Full Width Interior Freezer Section                      Energy Star (Optional)</p> <p><b>For Studio Unit - Small Refrigerator:</b>                      Energy Star qualified                      Top-mount freezer unit                      Capacity: 9.5 - 13.0 CF                      Dimensions: Max W - 24" (610 mm)                      Max H - 61" (1550 mm)                      Max D - 32" (810 mm)                      Vegetable Crispers</p> <p><b>For Single Family Unit - Medium Size Refrigerator:</b>                      Energy Star qualified                      Top-mount freezer unit                      Capacity: 14.5 - 17.0 CF                      Dimensions: Max W - 28" (711 mm)                      Max H - 66" (1680 mm)                      Max D - 33" (840 mm)                      Vegetable Crispers</p>	<p><b>For ACCESSIBLE/ADAPTABLE Single Family Unit and Larger units - Medium Size Refrigerator:</b>                      ADA Compliance                      Energy Star qualified                      Top-mount freezer unit with all controls not more than 1200 mm (4') above finished floor and allow one-hand operation                      Capacity: 14.5 - 17.0 CF                      Dimensions: Max W = 28" (711 mm)                      Max H - 66" (1680 mm)                      Max D - 33" (840 mm)                      Vegetable Crispers</p> <p><b>Or Wheelchair Accessible Units:</b>                      ADA Compliance                      Energy Star qualified                      Side by side refrigerator (no ice/water dispenser)                      Capacity: 22 CF                      Dimensions: Max W = 33" (840 mm)                      Max H = 66" (1680 mm)                      Max D = 33" (840 mm)</p>

ITEM	DESCRIPTION	STANDARD UNITS	WHEELCHAIR ACCESSIBLE/ ADAPTABLE UNITS
<b>Electric Range</b>	<p><b>For all models:</b>            CSA approved            Free standing            Self-clean (Optional)            4 Surface Elements: 6" and 8" Diameter            Removable drip pans            Broiler            Timer            Surface Element/Signal Light            Oven light            Oven racks: 2            Auto shut-off (oven)            Storage Drawer  <b>UL858 Standard Compliant (Temperature Limiting)</b></p>	<p><b>For Studio Units - Apartment size electric range:</b>            Dimensions: Max W - 24" (610 mm)            Max H - 48" (1220 mm)            Max D - 27" (690 mm)            Capacity: 2.5 - 3.0 CF</p> <p><b>For larger units/multifamily dwellings - Standard size electric range:</b>            Dimensions: Max W - 30" (760 mm)            Max H - 48" (1220 mm)            Max D - 28" (710 mm)            Capacity: 4.5 - 5.5 CF</p>	<p><b>For Studio ADAPTABLE Units:</b>            ADA compliance (or control panel on front)            Dimensions: Max W - 24" (610 mm)            Max H - 48" (1220 mm)            Max D - 27" (690 mm)            Capacity: 2.5 - 3.0 CF</p> <p><b>For ADAPTABLE larger Units:</b>            ADA compliance (or control panel on front)            Dimensions: Max W - 30" (760 mm)            Max H - 48" (1220 mm)            Max D - 28" (710 mm)            Capacity: 4.5 - 5.5 CF</p>
<b>Cook Top</b>	<p><b>For all models:</b>            CSA approved            ADA compliance            Surface Element/Signal Light            Removable Drip Pans            Timer            Easy access to controls  <b>UL858 Standard Compliant (Temperature Limiting)</b></p>	N/A	<p><b>For Studio:</b>            Dimensions: Max W - 16.5" (419 mm)            Max H - 4" (100 mm)            Max D - 22" (560 mm)            2 Surface Elements: 6" and 8" Diameter  <b>Provide cook top controls mounted at the front of the counter for wheelchair accessible units.</b></p> <p><b>For single family/multi-family ACCESSIBLE/ADAPTABLE units - Standard Electric Cook Top:</b>            Dimensions: Max W - 24" (610 mm)            Max H - 4" (100 mm)            Max D - 22" (560 mm)            4 Surface Elements: 6" and 8" Diameter  <b>Provide cook top controls mounted at the front of the counter for wheelchair accessible units.</b></p>
<b>Range Hood</b>	<p><b>For all models:</b>            CSA approved            Min. Airflow: 2 speed, 180CFM            Max Sones: 7.5            Convertible type            Installation type: 3 1/4 x 10 rectangular, 7" round  <b>Removable aluminum grease filter. Recirculating charcoal filter (ductless) range hoods acceptable only for Passive House projects, with approval from the Owner and AHJ</b>            Covered LED light</p>	<p><b>For 24" ranges:</b>            Dimensions: Max W - 24" (610 mm) Max H - n/a            Max D - 20" (510 mm)</p> <p><b>For 30" ranges:</b>            Dimensions: Max W - 30" (760 mm) Max H - n/a            Max D - 20" (510 mm)</p>	<p>For studio units, match with the size of the cooktop.            Provide remote switch at counter front for fan and light. Coordinate with electrical. Obtain CSA approval if required.</p>

ITEM	DESCRIPTION	STANDARD UNITS	WHEELCHAIR ACCESSIBLE/ ADAPTABLE UNITS
<b>Wall oven</b>	CSA approved ADA compliance, side opening oven door Broil Timer Self-clean (Optional) Oven Light Oven racks: 2	N/A	<b>For ACCESSIBLE units:</b> Dimensions: Max W - 27" (690 mm) Max H - 32" (820 mm) Max D - 26" (660 mm) Oven capacity: 3 - 5 CF
<b>Laundry</b>	Front loading, commercial grade washer/dryer, for common laundry. Residential type washer/dryers are not accepted.		Provide pedestals for accessible front loading side by side washer/dryers with accessible operating controls

## .2 COMMERCIAL KITCHEN REQUIREMENTS

### .1 Basic Requirements

- .1 Provide a commercial kitchen with equipment manufactured for the specific purposes intended and installed in strict accordance to the manufacturers' standards and any requirements of the Authority Having Jurisdiction.

### .2 Performance Criteria

- .1 Provide commercial kitchen equipment as required for the kitchen operation to prepare food for residents in the building.

### .3 Functional Areas

- .1 Provide areas for the following functional requirements; sample drawing for this space as included. Project architect shall provide the project specific drawings.
  - Administration
  - Dry Storage
  - Refrigerated/Frozen Storage
  - Preparation
  - Cooking
  - Washing
  - Service

### .4 Equipment Criteria

- .1 Provide commercial kitchen equipment as set by the kitchen consultant or AHJ based on facility needs.
- .2 All kitchen equipment is to be fabricated and installed to the current codes and requirements and the requirements of the Authority Having Jurisdiction at the time of installation including but not limited to SMACNA Guidelines for Seismic Restraint of Commercial Kitchen Equipment; Canadian Electrical Code, the Electrical Inspection Department Bulletins, the British Columbia Electric Safety Code; Canadian Gas Association, the Gas Utilization Code of the Department of Energy and Resources Management, British Columbia; BC Plumbing Code; and the Canadian Standards Association.

- .3 Equipment is to be in compliance, but not limited to, the current applicable section of NSF/ANSI Standard for Foodservice Equipment and the local Environmental Health Office.
- .4 Equipment is to meet or exceed the current energy saving guidelines in effect at the time of installation, including but not limited to EnergyStar certified, EnerGuide rating.
- .5 Equipment is to be installed as such to provide for adequate servicing and cleaning per current codes and requirements and the requirements of the Authority Having Jurisdiction at the time of installation.
- .6 .Materials for fixed surfaces will be impervious to moisture, corrosion resistant, smooth and able to withstand regular cleaning and sanitizing.
- .7 All service lines will be concealed within building walls or ceiling wherever possible; exposed lines to be covered with service chases.
- .8 Finished work must be perfectly true and plumb with no warping, buckling or open seams. All edges, hidden or exposed, must be ground smooth and rounded. Rivet heads, weld marks, or other imperfections are not acceptable.

**.5 Manufactured Equipment:**

- .1 Equipment is to be from a recognized manufacturer of commercial kitchen equipment with local service representation.
- .2 Cabinet type equipment to have locks.
- .3 Refrigeration equipment to have integral digital thermometers and alarm systems.
- .4 Equipment is to be on casters with brakes where possible.
- .5 Gas equipment to have quick disconnects with swivel and integral shut-off valves and restraining cords.

**.6 Custom Millwork:**

- .1 Custom fabricated millwork equipment to be from a company specializing in commercial kitchen millwork cabinetry.
- .2 Cabinet type equipment to have commercial grade plastic laminate finish; swing doors, concealed hinges with locks; drawers with locks; internal adjustable plastic laminate or melamine shelves; kickbase's to have stainless steel finish.

**.7 Custom Stainless Steel work:**

- .1 Custom fabricated stainless steel equipment to be from a company specializing in commercial kitchen equipment with local service representation.
- .2 Cabinet type equipment and drawers to have locks.
- .3 Stainless steel will be ASTM-A167-81A, (18-8 Analysis) type 304 cold rolled and annealed, No. 4 finish one side, 180 grit finish, and free of buckles, pits, warps and imperfections. Ensure the direction of grain matches throughout the units.
- .4 The gauge of metal and methods of construction will in all cases be adequate for the intended purposes of the equipment or structure. Refer to Commercial Kitchen Equipment article.

- .5 Finished equipment will be rigid when assembled and installed.
- .6 Faucets are to be low water consumption fixtures and from the same manufacturer.

#### **.8 Exhaust Hood:**

- .1 Provide ULC listed low air volume hood with demand ventilation (control) system and integral fire suppression system as required by current codes and requirements and the requirements of the Authority Having Jurisdiction at the time of installation, including but not limited to City of Vancouver K2 form requirements.
- .2 Provide a hand held fire extinguishing unit(s) as required for area.

#### **.9 Equipment Schedule**

- .1 Provide commercial equipment as outlined in Article 2.2 Commercial Kitchen Equipment.
- .2 Services and space to be allocated for the equipment listed which is to be provided by the Consultant.
- .3 Small wares and tools-of-the-trade are to be supplied by the Operator. Consult with BC Housing what small wares are to be provided by Operator.

#### **.10 Area Architectural Criteria**

- .1 All surfaces are to meet the current codes and requirements of a commercial kitchen establishment and the Authority Having Jurisdiction at the time of installation.
- .2 Area to be vermin resistant.
- .3 Floor: Fully sealed, water-impermeable, acid resistant, slip resistant heavy duty floor material i.e. slip resistant resilient sheet vinyl; with integral coved wall base - rated for a commercial kitchen application. Installation as to provide for no pooling of water under equipment.
- .4 Walls: smooth, water tight, washable. Fiberglass Reinforced Panels (FRP) at all exposed building walls and stainless steel insulated panels from the underside of the hood to the wall base. Painted wall in dry storage area. All exposed wall corners are to be protected with stainless steel corner guards.
- .5 Ceiling: 'T'-bar type as rated for a commercial kitchen application; smooth, washable, acoustic consideration. Provide for access to ceiling area for service to service lines/ducting.
- .6 Light levels: to meet all work environment conditions for area.
- .7 Room Ventilation: area to have sufficient efficient artificial ventilation / make-up air, air movement, and cooling for use of area and the number of staff working in the area. Coordinate with mechanical consultant for the required ventilation in this space.
- .8 Door(s): access doors/doorways are to be adequately sized for the installation and removal of equipment; with locks.
- .9 Security: area to be fully secured from adjacent areas. Provide lockable roll-down shutter in the server area.

## 3 Execution

- .1 Built-in appliances: Securely anchor to supporting cabinetry or countertops with concealed fasteners. Verify that all clearances are adequate for proper functioning and rough openings are completely covered or fully used.
- .2 Freestanding appliances: Place in designated locations and verify that all clearances are adequate to properly operate the appliance. Refer to CSA B651 for accessible units.
- .3 Set equipment in place, level and make necessary adjustments. Connect appropriate utilities, water, drains, venting, gas and electrical.
- .4 Clean equipment, ready for use and test for proper operation immediately prior to Substantial Completion of the Work.

End of Section

# 12 20 00 - Window Treatment

## 1 General

### .1 WINDOW TREATMENT STYLE

- .1 Provide horizontal or vertical louvered blinds to all exterior windows and doors, if required. Consider wand/rod control, in lieu of cords, to operate or tilt the blinds. Provide manufacturers written standard ten (10) year guarantee for blinds from the date of substantial performance.
- .2 Fabric drapes or roller blinds may be considered as an alternate window treatment for family **women transition and second stage housing**, or senior projects, if specifically requested by the Owner.
- .3 Submit one (1) representative working sample of a typical blind including all accessories for review by the consultant and Owner prior installation. Colour as selected from manufacturer's standard range.
- .4 Paints, coatings, adhesives and sealants must not contain methylene chloride and perchloroethylene. Paints and coatings must meet Canadian Volatile Organic Compound (VOC) Concentration Limits for Architectural Coatings Regulations (SOR/2009-264). Adhesives and sealants must meet SCAQMD Rule 1168, effective July 1, 2005.
- .5 Consider using materials that are sourced locally and have high recycled content.

## 2 Products

### .1 HORIZONTAL LOUVRE BLINDS

- .1 Aluminum: 25 mm (1") width, spring-tempered alloy, rounded corners with rough edges and burrs removed and resistance to internal and external corrosion with baked enamel coating.
- .2 Headrails: One-piece steel channel with rolled edges, formed to provide sufficient strength to support blind without sagging, twisting or distorting. Metal 24 gauge minimum.

### .2 VERTICAL LOUVERED BLINDS

- .1 Polyvinyl Chloride Vanes: 89 mm (3-1/2") wide with length to suit window opening, light stable, to ASTM D1784, thickness 0.25 mm (1/16"), one piece, full length extruded aluminum 6063-T5 alloy head rails.
- .2 Brackets: Sized to support weight of blinds plus forces applied to operate blind and designed to facilitate installation and removal of top rail, complete with hardware to secure attachment of brackets to adjoining construction and to headrails.
- .3 Operation: Traversing with louvers revolving 180° with positive mechanical control, without binding louvers at any angle. When traversed, blinds shall stack uniformly and tightly to allow maximum clear window openings.

**.3 VALENCE:** Same material and colour as blinds.

#### **.4 FABRIC DRAPES**

**.1** Pattern: Jeremy Flax (or equivalent), minimum density or weight of 326.0 grams per linear meter.

**.2** Machine washable and flame/fire retardant, with a ratio of 85% Trivera and 15% flax.

##### **.3 Track**

**.1** 25 mm x 19mm (1" x 3/4") extruded aluminum, 6063T5 aluminum alloy, manual operation, and powder coated off white.

**.2** Heavy duty brackets to accommodate ceiling and/or wall mount.

**.3** Ball bearing carriers and one 711 mm (28") fibreglass baton per drape.

##### **.4 Drape Construction**

**.1** Minimum of 89 mm (3-1/2") pleat, single heading constructed of woven pallon.

**.2** Fullness to be approximately 610 mm (2'-0"). of fabric to 305 mm (1'-0") of wall (2:1 fullness).

**.3** Seams to be serged with 50/50 polyester/cotton blend thread, bottom hems to be minimum of 76 mm (3") doubled, side hems to be 25 mm (1") doubled.

**.4** Heavy duty 38 mm (1-1/2") drapery hooks.

#### **.5 ROLLER BLINDS**

**.1** Hardware, shades fabric and aluminum/steel coating shall have a ten (10) year manufacturer's warranty.

**.2** Fabrics: inherently anti-static, waterproof, washable, flame retardant to NFPA 701 and NFPA 703, fungal resistant to ASTM G21, fade and stain resistant, light filtering, room darkening fabrics as selected by the Consultant and Owner.

**.3** Operating system: chain drive pulley operating, consisting of metal clutch housing and locking plug containing minimum 6 ribs and inserted at minimum of 57.2 mm (2-1/4") into roller tube. Provide smooth and trouble free operation, stainless steel ball chain, compliant with WCMA safety standard A 110.1

**.4** Roller tube: circular shaped aluminum tube, with 50.8 mm (2") outside diameter, providing additional tensile strength and allow for secure placement of clutch and end plug.

**.5** Bottom bar: sealed hem bar, extruded aluminum weight in a sealed fabric hem pocket provided uniform look.

## 3 Execution

**.1** Locate controls as directed by the Consultant. Ensure that the blind/drape operating controls are located at the opposite ends of opening doors and windows (if possible and does not hinder access to operate the controls).

- .2** Install blinds square, true-to line, with operable parts adjusted for smooth operation. Include centre brackets where necessary to prevent deflection of headrail.
- .3** Ensure maintenance and/or replacement can be performed to the blinds or drapes without damaging the surrounding gypsum board.
- .4** Supplier to review existing window controls to eliminate conflict with window covering installation.
- .5** Roller blind fabric shall be pre-measured and manufactured off-site. Fabric shall not travel sideways more than 3 mm (0.125") either direction.

End of Section

# 12 32 00 - Manufactured Wood Casework

## 1 General

- .1 Submit shop drawings of kitchen cabinets and bathroom vanities to the Consultant and BC Housing for review prior to fabrication. Shop drawings must show construction details of all architectural woodwork, general arrangements, locations of all service outlets, typical and special installation conditions, the material being supplied and all connections, attachments, anchorage and location of exposed fastenings, as applicable.
- .2 Confirm all dimensions at site prior to fabrication.
- .3 Shop drawings must be coordinated with final selection of ranges, dishwashers, refrigerators, washers, dryers and other appliances.
- .4 In addition to standard one-year warranty, provide a five (5) year warranty against delamination of finishes and two (2) years on hardware.
- .5 Where possible, wood products are recommended to be certified according to the Forest Stewardship Council (FSC). Alternately, specify requirements of other four three internationally recognized third-party audited certification systems such as CSA CAN/CSA Z809-08, Sustainable Forestry Initiative (SFI), or Program for Endorsement of Forest Certification Systems (PEFC). Where possible use local wood products.
- .6 Composite Wood to comply with California Air Resources Board (CARB) ultra-low-emitting formaldehyde (ULEF) resins or no added formaldehyde resins. Composite wood cannot exceed 0.05 ppm of formaldehyde as tested under EN-717-1:2004, ISO 16000-3:2010, ISO 16000-6: 2011, ISO 16000-9:2006, ISO 16000-11:2006 or CEN/TS 16516: 2013. Refer to [Energy and Environmental Design](#) section.
- .7 All materials workmanship and equipment shall conform to the architectural woodwork specifications as set forth in the Quality Standards for the Architectural Woodwork Manufacturers Association of Canada (AWMAC), Canadian Kitchen Cabinet Association (CKCA), or CAN 3-A278M for residential kitchen cabinets and bathroom vanities.
- .8 Coordinate with [Division 06 20 00 - Finish Carpentry](#) and [Division 07 92 00 - Joint Sealants](#).
- .9 Paints, coatings, adhesives and sealants must not contain methylene chloride and perchloroethylene. Paints and coatings must meet Canadian Volatile Organic Compound (VOC) Concentration Limits for Architectural Coatings Regulations (SOR/2009-264). Adhesives and sealants must meet SCAQMD Rule 1168, effective July 1, 2005.
- .10 Consider using materials that are sourced locally and have high recycled content.

## 2 Products

### .1 RESIDENTIAL AREAS:

- .1 Kitchen & Bathroom Cabinets and Vanity: cabinets and vanity units shall be the **manufacturer's** modular units comprising **of** base cabinets and wall cabinets, as **indicated in the drawings**.
  - .1 Fabrication of Cabinets:
    - .1 The upper and lower cabinets must be high density particle board, sustainable design particleboard (SDP) M3 grade, wheatboard or low VOC plywood, finished on interior with melamine, zero formaldehyde construction that meets the ANSI A208.1
  - .2 All cabinets shall be 19 mm (3/4") cases unless otherwise specified, with interior and exposed exterior gables, both sides of shelves and upper cabinet bottom covered with melamine. Back shall be 3 mm (1/8") hardboard covered with melamine to match inside of cabinet. Exposed sides of cabinets, facia panels and microwave shelves to be high density plastic laminate (HPL).
  - .3 All cabinets over 813 mm (2'-8") wide must have mullion installed adding a fifth support for the adjustable shelves.
  - .4 Front edges of gables and shelves must be 2.0 mm impact resistant PVC edge banded. Bottom of gables beside toilets to be finished with melamine so that all exposed wood is covered. colour matched.
  - .5 Base kicks, match to the cabinet with plastic moldings at outside corners of base cabinets. Toe space at all base cabinets shall be 152mm deep by 203 mm high (6" x 8") for accessible suites and for other units minimum 76 mm deep by 100 mm high (3" X 4").
  - .6 Cabinets must be assembled with dowels and bolts.
  - .7 Cabinet Hanging Rails: High-density particle board, wheatboard or low VOC plywood concealed.
  - .8 Door Hinges: concealed 110° opening, all metal, spring loaded, self closing, six-way adjustable hinges, completely concealed. For high use application, use a 3<sup>rd</sup> hinge.
  - .9 Drawer Construction: Sides, backs, and sub-fronts SDP particleboard or wheat board finished with melamine. Bottom must be 3 mm (1/8") hardboard, paint finished or melamine to match side rails. Finish exposed edges of drawers with PVC edging colour matched. In case of low VOC plywood construction, sides and back 13 mm (1/2"), bottom 3 mm, finished with low VOC clear sealer.
  - .10 Drawer Slides: Drawers must be fitted with epoxy coated full extension metal slides on tandem runners with safety stops to prevent tipping, minimum 40 kg (88 lb) capacity. For high use application, sliders should be captive ball-bearing style to have increased capacity.
  - .11 Door Bumpers: Provide plastic door bumpers on doors and drawers, for sound absorption.
  - .12 Screw Caps: Provide colour coordinated screw caps over screw heads exposed to view.
  - .13 Kick Space Heater Access: Where kick space heaters are provided in bathrooms or kitchens, install an access panel for servicing of the heater. Access panel to fully cover bottom of base cabinet. Contractor shall coordinate with other trades involved for location and sizing of grill opening and access panel.

- .14 Style: frameless or face frame. Face frame minimum 12 mm (0.47") and frameless minimum 16 mm (0.63"). Materials used in all facets of box construction must be consistent when using certified materials.
- .15 Upper Cabinets: Standard full height doors, minimum 762 mm (30") high.
- .16 Base Cabinets: Drawers and swing out doors to arrangement as shown on the drawings. Sink cabinet to have two fixed panels across top. Provide a minimum of four sliding drawers.
- .17 Doors and Drawers: High pressure laminate surface on high density particleboard, low VOC plywood or SDP core with 90 degree, full wrap edging and 2.0 mm PVC edge banding. Fix drawer front to drawer body with mechanical fastenings. One drawer must have a minimum depth of 178 mm (7"). Recommendation to use low VOC, high quality plywood for wet and high use areas. Provide manufacturer's standard lazy susan to base corner cabinets in each kitchen. Provide one lockable sliding drawer in the bathroom vanity on each unit.
- .18 Pulls/Handles: 102 mm (4") nylon or brushed chrome, "D" pulls. No pulls in inactive doors or drawers.
- .19 Wheelchair Accessible Units: In addition to the above items, provide 2 pull out work surfaces with surface mounted pulls.

## .2 COUNTER TOPS

- .1 Plastic Laminate: American National Standards Institute/National Electrical Manufacturer's Association (ANSI/NEMA), LD 3-2005, "High Pressure Decorative Laminate", Type HGS, 1 mm (0.040") thick.
- .2 Counter tops must be one-piece factory "postformed" type with bullnosed edges and minimum 90 mm (3.5") high backsplash and sidesplash, composed of high pressure laminate bonded to a SDP M3 grade particleboard core, zero formaldehyde construction that meets the ANSI A208.1 High use application, use "layup" type with seams to be located in dry locations; include 90 mm (3.5") high backsplash and sidesplash with continuous bead of sealant to prevent water penetration.
- .3 Unless otherwise shown on the drawings, kitchen tops must be 648 mm (25-1/2") wide. Vanity tops must be 572 mm (22-1/2") wide
- .4 Provide cut-outs in tops for all sinks and plumbing fixtures to templates supplied by plumbing subcontractor at the time of installation. Seal all edges with coloured sealer in accordance with Architectural Woodwork Standards (AWS).

## .3 WOOD CASEWORK (COMMON AREAS AND OFFICE)

- .1 Confirm to the latest edition of the architectural woodwork specifications as set forth in the Quality Standards for the Architectural Woodwork Manufacturers Association of Canada (AWMAC).
- .2 If required by the Owner and as specified by the Architect, a two (2) year guarantee from AWMAC can be considered for this section. An independent inspection (approved by AWMABC) can be considered to confirm the manufacture of this work and installation. Such inspection costs shall be included by the contractor if required by the specifications. Any work that does not meet AWMAC, shall be replaced at no cost to the Owner.

- .3 Casework and drawer with high pressure laminate: high density particle board, wheatboard or low VOC plywood, 90 degree full wrap c/w 2 mm PVC edging top and bottom, high pressure laminate selection. All cabinet hardware and finishes shall conform to AWMA, Architectural Woodwork Standard (AWS).
- .4 Countertop with high pressure laminate: Confirm to AWMAC, 32 mm (1.25") square wrap edge and trim.

## 3 Execution

- .1 Supply and install all filler panels, back panels or scribe moulding, etc., to make a complete and finished installation.
- .2 Apply a bead of silicone sealant to junctions of plastic laminate and wall surfaces and at the cabinet base/floor junction.
- .3 Apply a bead of silicone sealant around the base of plumbing fixtures penetrating the countertop.

End of Section

# 13 20 00 - Heat Treatment Room (Optional)

## 1 General

- .1** The provision of a heat treatment room shall be project specific. It is intended to provide an Operator the ability to prevent and manage bed bug infestations using high-temperature heat to effectively exterminate bed bug eggs, larva/nymphs and adults from tenant's belongings and furnishings. Materials and workmanship for the room construction will be specified in their related sections.

If a permanent heat treatment room is not provided, consideration should be given for provision of electrical rough-in to power a mobile heat treatment trailer if required by the Operator. Location should be accessible by building staff and where a mobile trailer can approach the building. Access to be secured for authorized use. Consult with the Owner/Operator for further details.
- .2** The heat treatment room's is recommended to be 3.0 m – 4.5m (10' – 15') long and 3.0 m – 3.6m (10' – 12') wide and if publicly accessible include a vestibule a min. 1.2 m x 1.2 m (4' x 4').
- .3** Do not install any unnecessary penetrations such as exhaust vents or drains. These provide a place for bed bugs to escape, heat loss, potential failure of fire damper, and wasted energy. If exhaust ventilation is required it should be from outside the room in the vestibule.
- .4 TREATMENT ROOM**

  - .1** Can be located in basement or service area and away from tenant, support or amenity areas. If possible heat treatment room should be in close proximity to the elevator and a building service entrance and close to building exterior walls.
  - .2** Should be large enough to hold a three person couch, box spring and mattress, bed side table and chest of drawers. Furniture and other items are to be placed in the room to ensure that there is adequate air circulation to allow for heat penetration. Racks should be considered to ensure adequate air circulation around the furniture and materials being treated.
  - .3** Ensure that the floor is insulated to a minimum RSI 3.5 (R20), walls insulated to a minimum RSI 3.87 (R22) and ceiling insulated to a minimum RSI 4.93 (R28).
  - .4** Wall construction to consist of an insulated stud wall, aluminum heat reflective foil, cementitious board and batten finish.
  - .5** Ceiling construction to consist of insulated ceiling cavity, gypsum board, aluminum heat reflective foil, cementitious board and batten finish. The ceiling assembly to have gypsum board installed to provide a minimum 1 hour fire resistant rating.
  - .6** Avoid placing any other systems that are not part of the Heat Treatment room, like electrical, plumbing or HVAC systems in the ceiling construction.
  - .7** Number of sauna heaters or approved portable heaters is **dependent** on the room's cubic foot print. Refer to the manufacturer's specifications for heaters or portable heaters as to the maximum cubic space allowed.

- .8 Heater controls are to be set at a temperature of 60 degrees Celsius and, depending on the room configuration and heater capacity, run continuously for at least two (2) hours; denser packed items (i.e. mattresses, bags of clothes, furniture, etc.) may require more than two (2) hours for the temperature to saturate the material and effectively neutralize the bed bugs.
- .9 The room is to have a minimum one (1) hour fire-resistant rating.
- .10 Controls, light switches, breaker boxes, electrical panel, relay box or any other heat sensitive electrical components to be located in the vestibule or outside the heat treatment room in a mounted lockable box.
- .11 The Contractor shall supply all equipment, power, extension cords, signage or any related items necessary for the room. At construction completion, the Contractor shall commission the heat treatment room by doing a complete test-run and provide training and an operating manual for building maintenance.

## **.5 ENTRY VESTIBULE (ONLY IF HEAT TREATMENT ROOM IS ACCESSIBLE TO PUBLIC)**

Vestibule doors should be in direct line of each other and must open out of the rooms. Provide a standard vision light to the heat treatment room door. Vestibule doors should have door closure.

## **.6 OPERATION OF THE HEAT TREATMENT ROOM**

- .1 Tenant's belongings are to be isolated (bagged) and transported into the room prior to the room being activated.
- .2 Electrical items (such as sensitive electronic equipment) can be placed inside the heat treatment room but should remain at the floor level of the heat treatment room and away from the heater to avoid overheating.
- .3 Spread items out on shelves, hangers or racks as much as possible so the items get hot enough to kill the bugs.
- .4 Once the heater(s) is activated the room is to be left undisturbed for the desired time frame. Operators of the heat treatment room are to be trained for proper use of the heaters and warned about proper precautions around the hot elements.
- .5 Once the tenant's belongings have been heat treated allow the room to cool down for a minimum 30 minutes before entering. Opening the doors to the heat treatment room allow for the ambient temperature to cool more rapidly. Metal items may still be too hot to touch, wear appropriate gloves to protect hands.

## **.7 OTHER**

- .1 Hose bibs are not permitted in room. Floor drains are permitted in the vestibule or just outside the heat treatment room providing that they are installed with trap primers.

## 2 Products

- .1** Aluminum Heat Reflecting Foil: 914 mm (36") wide roll of pure aluminum foil, glue mounted to super strength Kraft paper and micro-perforated, available from local heater suppliers.
- .2** Cementitious Tile Backer Board: 1/2" cementitious tile baker board; refer to [Division 09 28 00 - Gypsum Wallboard](#).
- .3** Extruded Polystyrene Insulation: Refer to [Division 07 21 00 - Thermal Protection](#) for Insulation.
- .4** Gypsum Board: Refer to [Division 09 28 00 - Gypsum Wallboard](#) for Fire-resistant Gypsum Board.
- .5** Heat Source: Commercial quality, portable electric heaters with combination of panel fan (specifically designed for bed bug treatment) to be heavy duty, rugged sheet metal enclosure with expanded metal inlet and exhaust screens. Ensure that the temperature sensor is located at heater units.  
  
Coordinate selected heater with electrical consultant and trade. The heater should be hardwired and not portable. Consult with manufacturer warranty and electrical consultant. If heater unit has multiple feeds provide individual breakers for each feed. Consider an additional on/off switch for emergencies. Control box of the heater shall be wall mounted outside the room in lockable cabinet so operator can turn off the heater without entering when the room is operational.  
  
Heater equipment must be CSA/UL tested and listed or independent testing agency certified. Heaters should have standard 1 year warranty on labour and material as well as 2 years warranty on the resistor elements.
- .6** Heater Fence: For heater installation only, S4S, kiln-dried clear vertical grain 38 mm x 89 mm (2 x4).
- .7** Interior Floor Sheathing: Refer to [Division 06 10 00 - Rough Carpentry](#) for Interior Floor Sheathing.
- .8** Joint Treatment: Heat resistant low VOC sealant. Acceptable Product: Trimsil 600 by Tremco or approved equal.
- .9** Metal Door: Insulated lockable metal door, refer to [Division 08 11 00 - Metal Doors and Frames](#) for Exterior Service Room Exit Doors. Door width to be minimum 900 mm (3') clear doorway opening.
- .10** Finished Hardware: refer to [Division 08 70 00 - Finish Hardware](#) for Metal kick plates, door hold open device; (public door) exterior key lock with free access from interior; (room door) weather stripping: rigid rubber door sweep or the door frame to be outfitted with a compressible gasket constructed with flexible insert on a rigid metal strip and a standard vision light.
- .11** Mineral Fibre Insulation: Semi Rigid Insulation/Mineral Wool Insulation. Conforming to CAN/ULC-S702, Type 1, Flame Spread Rating of  $\leq 25$ ; Smoke Developed Rating  $\leq 0$  with a mass of 1.22 kg/m<sup>2</sup>.
- .12** Resilient Sheet Flooring: Refer to [Division 09 65 00 - Resilient Flooring](#) for slip resistant sheet vinyl for bathrooms for non-barefoot areas.

- .13** Safety Labeling: Safety Design Label form, or name plate as a permanent information sheet.
- .14** Timer & Temperature Controls: Digital control with a programmable temperature and timer combination with a maximum time setting of at least 2 hours. If required the timer could be set up for longer duration. Provide only one switch to turn on/off the timer and temperate control.
- .15** Sprinkler Heads: High temperature resistant, wire guard, fast response sprinkler head with an activation temperature above 150 degree Celsius for bed bug room and vestibule. It is recommended to provide a separate fire zone for bed bug room , if the location is publicly accessible.
- .16** Lighting: High temperature resistant industrial light fixture complete with metal wire guard. Refer to [Division 26 00 00 - Electrical](#). Provide the lighting switch outside the room.
- .17** Portable Fans: Additional fan for heat circulation must be metal and high temperature resistant.

## 3 Execution

- .1** Floors are to be insulated to a minimum RSI 3.5 (R20) and covered with the interior floor sheathing. The floor sheathing is to be glued and screwed. Do not use concrete topping or gypsum concrete as this will affect the floors ability to reach the designated temperature within the given timeframe (it will act as a heat sink).
- .2** Insulation to be installed in the wall and ceiling framing in accordance with [Division 07 21 00 - Thermal Protection](#).
- .3** Start installing the aluminum heat reflective foil at the bottom of the wall and positively lap additional rows as the foil is installed up the wall. Overlap seams 75mm (3"), seal joints and punctures with foil heating duct tape.
- .4** Install cementitious tile backer board and ceiling's gypsum board in accordance with [Division 09 28 00 - Gypsum Wallboard](#). The cementitious wall board is to be installed vertically to ensure that only a continuous vertical joint is located on the walls. After the installation of the resilient flooring with cove base and finish, install the batten over the vertical wall joint to the floorings aluminum finish edge. The board joints are to be sealed and the batten is to be back caulked to both sides of the board's joint. Fasten the batten as required.
  - .1** If a finish is desired the cementitious board and batten should be finished with MPI dry heat resistant to 60 degree Celsius INT 3.3D Epoxy Modified Latex. If the cementitious board is not primed use MPI 3 Alkaline resistant primer.
- .5** Sealant is to be installed in accordance with [Division 07 92 00 - Joint Sealants](#). Ensure proper joint design between the cementitious boards. Install sealant between the bottom of the cementitious board and subfloor prior to the installation of the resilient floor to ensure that sealant is installed behind the cove base.

- .6 Sealant is to be applied continuously around the perimeter of the batten's backside.
- .7 Flooring to be installed in accordance with [Division 09 65 00 - Resilient Flooring](#). Cove base the perimeter of the floor to a min. 4" up the wall and finish with an aluminum edge. The flooring is to be 100% adhered to the substrate using a solvent free 2-part urethane adhesive.
- .8 Ensure that the power requirements, air circulation and unit fastening is completed as per the manufacturer's specifications. Connect the heater power cable to the main disconnect device and sauna heater controls as per the manufacturer's specifications.
- .9 The fencing around the heater is to be installed as per the clearance requirements from the manufacturer's specifications. The fencing is to be continuous from the floor to the ceiling to ensure materials cannot touch the heater. Ensure that access can be achieved to the unit for proper maintenance or replacement of parts.
- .10 The controls are to be installed on the wall adjacent the opening side of the door leading into the heat treatment room. Install the heater controls at a height of 1219 – 2032 mm (4' – 5'). If more than one heater is installed there should only be one set of controls.
- .11 Place caution/warning signs around the heaters warning the heater(s) could be extremely hot and do not touch.
- .12 Place a warning sign on the door to the heat treatment room warning:
  - .1 That the room is not to be entered when the heaters are operating and allow for a 20 minute cool down prior to entering the room.
  - .2 Wear protective gloves (to prevent burns which may be caused from touching hot or metal objects).
- .13 Install an electrical outlet in case additional ventilation is required inside the room to circulate heat. Add a manual switch to turn on/off in the vestibule or outside the room for this.
- .14 Other signage to be considered:
  - .1 **'DO NOT TOUCH - MAY BE HOT'** on door to Sterile room or door to vestibule
  - .2 **'DO NOT PLACE ITEMS IN THIS AREA THAT COULD TIP / FALL AND BLOCK THE DOOR'** in a) sterile room door sterile room side, in b) sterile room vestibule wall between sterile room door and vestibule door, and c) outside sterile room door at the hinge jamb side of the door.
  - .3 **'DO NOT PLACE OBJECTS IN THIS AREA THAT COULD TIP / FALL ONTO THE HEATER'** on the walls both left and right sides of the sauna heater protection 'frame'.
  - .4 **'EXTREMELY HOT - DO NOT TOUCH'** on the sauna heater protection 'fence guard'.
  - .5 **'DO NOT ENTER ROOM WHEN HEATERS ARE OPERATING - ALLOW FOR 20 MINUTE COOL DOWN PRIOR TO ENTERING THE ROOM'** on the sterile room door (vestibule side).
  - .6 **'KEEP AREA CLEAR'** in front of the heater as per the heater manufacturer's specifications.

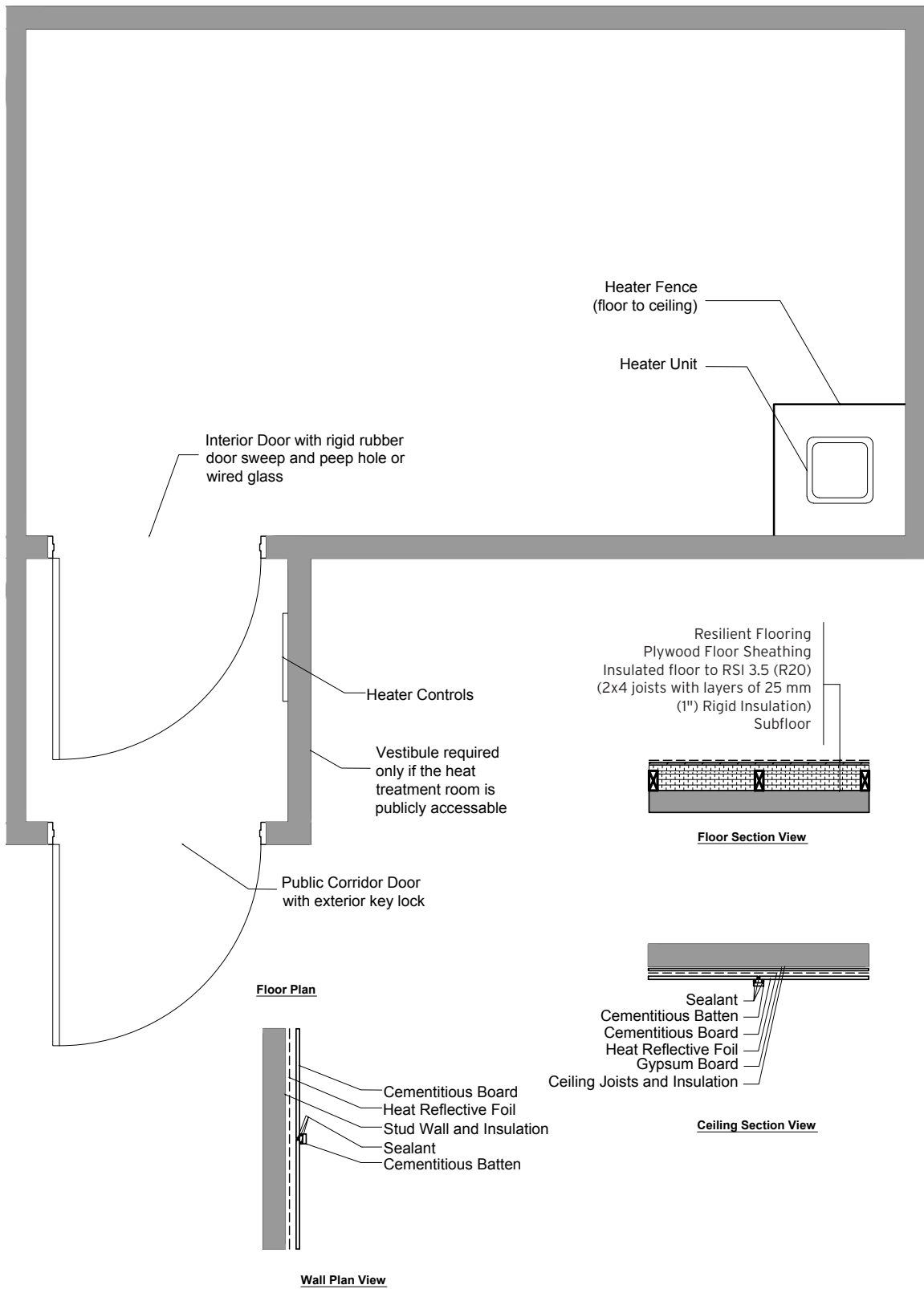

End of Section

# 14 20 00 - Elevators

## 1 General

### .1 RELATED WORK BY OTHER TRADES

- .1 Elevator hoistways must be constructed of poured concrete or reinforced concrete block. Consult with BC Housing prior to considering Cross Laminated Timber (CLT) hoistways.
- .2 Elevator pits must be constructed of poured reinforced concrete and designed to withstand the static and dynamic loading imposed by the equipment. Pits must be waterproofed and have a drain complete with a backcheck valve or other means to prevent water or other liquid to enter the elevator pit. Where provided or necessary, sumps and/or sump pumps shall not be located or accessed from the elevator pit. Elevator pit drains must be designed for a flow rate of 50 gpm per elevator.
- .3 For conventional elevator machine rooms must be provided with a poured concrete floor, reinforced to withstand the static and dynamic loading imposed by the equipment and the anticipated occupant load.
- .4 Elevator machine rooms, control rooms, controls spaces, and machinery spaces including the hoistway overhead machinery space for the machine-room-less elevators must be provided with mechanical ventilation and / or cooling to maintain a suitable operating environment for heat sensitive controls and equipment.
- .5 A three phase power supply and fused, lockable disconnecting means must be provided in the elevator machine and/or control room for each elevator with feeder wiring to the elevator control system.
- .6 Energy efficient design and operation should be considered in the specification of elevator equipment.
- .7 Pipes, ducts and other mechanical or electrical equipment not used in connection with the elevator must not be installed in any elevator hoistway, machine and/or control room, control space, or machinery space.
- .8 Ensure the top of the elevator shafts are fully insulated when at the attic level.
- .9 Provide fire alarm signals from the building fire alarm system to each elevator machine and/or control room or control space to activate emergency recall operation of the elevators. Fire alarm signal requirements shall be provided from the following devices and as applicable to the particular installation:
  - .1 A signal representing smoke detectors located in each elevator lobby (excluding the smoke detector at the main recall level elevator lobby).
  - .2 A signal representing the smoke detector(s) located in the elevator lobby at the designated recall level for alternate floor recall as required by the B44 Elevator Safety Code.
  - .3 A signal representing smoke detectors located in the elevator machine room, control room, control space or machinery space. Note: for machine-room-less elevators the top of the

hoistway is typically considered a machinery space and therefore would be required to be equipped with smoke detectors.

- .4 A signal representing smoke or heat detectors (if present) that are located in the top of the elevator hoistway.
- .5 A signal representing the smoke or heat detectors (if present) that are located in the elevator pit.
- .10 Provide a dedicated telephone line and jack in each elevator machine and/or control room for use by the elevator emergency communication system.
- .11 If applicable, coordinate access security system (cameras, card readers, etc.) with electrical and security consultants and trades.

## .2 MAINTENANCE MANUALS AND SERVICE

- .1 Provide complete operating and maintenance data manual and record drawings showing as-built wiring diagrams.
- .2 Furnish monthly maintenance and callback service on elevator described herein for a period of twelve (12) months commencing on the date of Substantial Performance of the Work. This maintenance must include systematic examination, adjustment and lubrication of all elevator equipment. Repair and replace electrical and mechanical supplies and parts of the elevator equipment and use only genuine standard parts produced by manufacturer of equipment concerned.

## .3 REFERENCED STANDARD

All elevators are required to comply with the latest version of the CSA B44 Safety Code for Elevators in effect for the jurisdiction of the work, including any applicable supplements. The requirements of the BC Safety Standards Act and Elevating Devices Safety Regulation shall also apply.

# 2 Products

- .1 Passenger Elevators shall have a minimum capacity rating and size as indicated in [Section 1 - Design Guidelines - Elevators](#).
- .2 Types of elevators, Elevator number, type, speed, size, capacity and minimum dimensions to be in accordance to [Section 1 - Design Guidelines - Elevators](#).
- .3 Microcomputer, non-proprietary control systems and energy efficient drives must be provided for all elevators.
- .4 Provide elevator control systems with non-proprietary diagnostics which will permit on-going maintenance and service by any qualified elevator contractor. Parts and technical support shall be available directly from the control system manufacturer to a third party elevator contractor and/or the Owner on a fair and expedient basis.

.5 The elevator equipment shall be provided with the following finishes:

ELEVATOR	FINISHES - DESCRIPTION
<b>Cab Front Finish</b>	Finish the cab front return panel, header, door posts, and car door panel in #4 finished brushed stainless steel.
<b>Cab Side, Rear Wall Panels</b>	Finish the cab side and rear wall panels with raised plastic laminate faced panels on low VOC wood cores. Provide stainless steel or plastic laminate reveals. Provide colour contrast between cab walls and floors.
<b>Cab Floor</b>	The cab floor must be finished in a non-slip raised rubber floor tile or equivalent flooring (flooring to be provided by other trades). Provide flooring that is easily recognizable (ie. Not a solid dark surface or dark colours).
<b>Handrails</b>	Minimum 38 mm (1-1/2") diameter stainless steel handrails on all non-access walls or other approved graspable design. Handrails shall be installed and mounted 800 mm– 920 mm (31.5" - 36") above the finished floor and 38 mm (1-1/2") clear of finished walls.
<b>Cab Ceiling &amp; Suspended Ceiling</b>	The cab ceiling should be finished with a white baked enamel paint finish or white plastic laminate and shall be equipped with a suspended ceiling. Suspended ceiling to consist of aluminum T-bar frame complete with aluminum eggcrate light diffuser panels or white translucent diffusers.
<b>Car and Landing Sills</b>	Extruded Aluminum, Stainless Steel, or Nickel-Silver. Landing sills shall be of contrasting colour to the adjacent floor surface.
<b>Cab Lighting</b>	Provide long life energy efficient LED downlights with warm white colour temperature of no greater than 3000 K.
<b>Accessories</b>	Provide stainless steel protective pad hooks for all walls except the entrance. One complete set of fire retardant protective pads of quilted canvas or vinyl must be provided at other than entrance walls.
<b>Hoistway Entrance Frames</b>	Hoistway entrance frames must be of standard profile suitable for the finished wall dimensions. All hoistway entrance frames and door panels must be finished with prime coat paint suitable for finish painting on site.
<b>Car and Hall Operating and Signal Fixtures</b>	Stainless Steel Brushed Finish faceplates or housings.

.6 The elevator equipment shall be provided with the following features:

ELEVATOR	FEATURES - DESCRIPTION
<b>Barrier Free Design</b>	All elevator equipment shall be provided in conformance with Appendix E of the B44 Elevator Safety Code "Elevator Requirements for Persons with Physical Disabilities"
<b>Voice Communication</b>	Provide each elevator with a vandal resistant, autodialing, hands free speaker/microphone type telephone mounted in a stainless steel plate and flush mounted into the elevator front return panel. Where elevator travel is greater than 18 m (60') provide an elevator "lobby" telephone that is accessible to emergency personnel.
<b>Door Operation</b>	Elevators must be provided with a high speed heavy duty variable speed door operator and complete with closed loop controls between door operator & and related equipment. The door operator must be capable of operating the doors smoothly and quietly at the time indicated in the performance requirements specified herein. Elevator doors should remain open for at least 5 seconds and should close slowly to allow extra time for people with disabilities where applicable.
<b>Door Re-Opening Device</b>	An infrared multi-beam door re-opening device must be provided to monitor the door opening and protect passengers from the closing doors. The device shall stop and reopen the doors should a person or other obstruction be detected. For Seniors projects provide a 3 - Dimensional device that also scans the area between the entrance frames in addition to the area directly in the path of the car doors.
<b>Operating Buttons - Type, Illumination &amp; Size - Bachelor and Family Projects</b>	All operating buttons shall be of a vandal resistant design suitable for rugged use. Illumination of all operating buttons must be provided from a long life LED source rated for 100,000 hours operation and must be clearly visible in the ambient lighting levels.
<b>Operating Buttons - Type, Illumination &amp; Size - Seniors Projects</b>	Buttons should have a contrasting colour to their background. Illumination of all operating buttons must be provided from a long life LED source rated for 100,000 hours of operation and must be clearly visible in the ambient lighting levels. The use of large or oversized buttons approximately 38 - 50 mm (1.5"-2") round or square is encouraged.

ELEVATOR	FEATURES - DESCRIPTION
<b>Position Indicator-Car</b>	Each elevator car must be provided with a digital position indicator with an LED display. The indicator must be mounted a minimum of 1980 mm (6'-6") above the finished floor level in the cab for easy viewing. The position indicator display shall contain a segment which displays the direction or intended direction of the travel of the car.
<b>Position Indicator - Hall</b>	Each elevator must be provided with a hall position indicator located at the ground floor level. The indicator display must be the same as the indicator provided in the elevator cab.
<b>In-Car Lanterns</b>	When a single elevator is used, provide an in-car lantern mounted in the car door jamb. The fixture shall contain direction arrows and an audible signal to indicate the direction of travel with adjustable volume control.
<b>Hall Lanterns</b>	When more than one elevator is provided in a group, then provide hall lanterns at all levels with double stroke electronic chime with an adjustable volume control to visually and audibly indicate the direction of travel. Hall lanterns shall provide advanced warning of the arrival of an elevator at a landing and shall illuminate and sound approximately 3 seconds prior to the arrival of the car and door opening.
<b>Voice Announcer (Optional)</b>	If required, provide an audible voice announcer to indicate the direction of travel and the floor level when the elevator is stopping and as the doors are opening. This shall be provided for all elevators regardless of the rated speed.
<b>Auto Light and Fan Shutoff</b>	Control system to automatically shut off the cab lighting and cab ventilation fan after a predetermined time period once the elevator is idle.

**.7** All elevators are required to meet the following Performance Criteria:

INDIVIDUAL ELEVATOR PERFORMANCE CRITERIA	
Performance Criteria	Machine-Room-Less or Conventional Traction Elevators
Leveling Accuracy	+/- 3 mm (1/8")
One Floor Run Flight Time	10 seconds
Door Open Time	2.5 seconds
Door Close Time	3.5 seconds
Maximum Rate of Acceleration	1.0 m/s <sup>2</sup> (3.5 ft/s <sup>2</sup> )
Maximum Rate of Change of Acceleration	2.4 m/s <sup>3</sup> (8.0 ft/s <sup>3</sup> )

**.8** Sound Isolation: The machinery and control room equipment, including controllers, and traction machines must be mounted securely to the machine and/or control room walls or floors and be sound isolated to prevent the transmission of sound to the building structure. An acoustic and vibration specialist should be consulted when selecting the equipment.

**.9** Provide for independent service operation by a designated attendant to facilitate tenant moves and other service use of the elevator.

- .10** Provide Firefighter's Emergency Operation Phase I & II for all elevators. Provide Automatic Emergency Recall operation for all elevators initiated by smoke detectors in the elevator lobbies, machine room, control room, control space or machinery space and any detectors that may be provided in the elevator hoistway or pit only. Provide Automatic Recall operation to an Alternate Level. Provide Phase II Emergency in-car operation for each elevator. These features shall be provided for all elevators regardless of building height per the requirements of the B44 Safety Code for Elevators. Elevators shall not be designated for use by Firefighter's unless required by the applicable building code. (Note: elevators designated for use by firefighter's in accordance with section 3.2.6.5 of the Building Code must also be provided with emergency power operation).
- .11** Door Nudging operation is not suitable for use on elevators in Seniors projects and shall be disabled as permitted by the B44 Safety Code for Elevators when Automatic Emergency Recall operation is provided. Do not provide door nudging operation in normal use of elevators in Senior's projects.
- .12** For machine-room-less elevators, provide means to release the elevator brake from the elevator control room regardless of its location. Do not provide access panels into the hoistway for the purposes of brake release unless they are located within the elevator control room area.
- .13** For machine room-less elevators provide self-resetting governors complete with a means to remotely reset the over-speed switch and to activate the governor for testing purposes to comply with the relevant sections of the Elevator Safety Code. Do not provide governors that require access panels in the hoistway enclosure.

### 3

## Execution

Not Applicable

End of Section

# 21 00 00 - Fire Protection

## 1 General

- .1** Provide a complete sprinkler system for the building in accordance with the requirements of BC Building Code (BCBC), National Fire Protection Association Standards (NFPA), code equivalencies and as required by the Authority Having Jurisdiction..
- .2** Refer to [Section 1 - Design Guidelines, Fire and Life Safety Measures](#), for a summary of all fire and life safety system requirements. Note that these requirements must meet or exceed the requirements of the BCBC and/or the Authority Having Jurisdiction.
- .3 QUALITY ASSURANCE**
  - .1** Sprinkler systems and all equipment shall be installed by qualified contractors licensed and regularly engaged in the installation of automatic fire sprinkler systems. Refer to [Division 23 00 00 HVAC](#) for details on tradesmen qualifications.
  - .2** All pipe, sprinklers, valves, fittings, gauges, pipe hangers, and other accessories to be of a type which is listed or labeled by Underwriters Laboratories of Canada (ULC). Use of such materials and equipment shall conform to all requirements and limitations of their listings and the manufacturer's specifications. If suitable ULC listed or labeled products are not available, products listed by other testing agencies (FM, UL, Warnock Hersey, etc.) may be used subject to the prior written approval of the Consultant, Owner, BC Housing and Authority Having Jurisdiction.
  - .3** In order to provide a better quality assurance of the mechanical design, BC Housing may retain an independent consultant to provide a design review at the end of the design development stage. The mechanical Engineer of Record will be asked to provide all relevant information for the independent review and will be requested to address any potential design issues and comments brought up by the reviewer before moving to next design stage.
- .4 SUBMITTALS**

Sprinkler system shop drawings complete with hydronic calculations as outlined in NFPA Standard shall be sealed by the fire protection system design engineer who is a Professional Engineer Registered in BC.
- .5 WARRANTY**

Provide full 2 years warranty for all labour and materials along with full 2 years of service contracts for projects under Part 3 buildings for new construction and as appropriate for renovation projects for overall mechanical systems including control systems. For Part 9 projects, provide one year warranty with full one year of service contracts.

For service contracts refer to [Division 23 00 00 HVAC](#) for detail.

## **.6 MANDATORY MECHANICAL SYSTEM COMMISSIONING**

- .1** All BC Housing projects shall require mechanical, HVAC, and plumbing systems commissioning by an independent commissioning provider. Refer to Section 4, Division 01 91 00 - Building Commissioning to establish the commissioning requirements and activities for the mechanical contractor.
- .2** BC Housing or Owner will conduct an independent commissioning option as outlined in Division 01 91 00 - Building Commissioning based upon the local re-zoning by-laws, project classification and size/complexity of the building. This should not replace the consultant, contractor, their sub-contractors or their own 3rd party agency's responsibilities in the contract documents.
- .3** The general contractor is responsible for coordinating integrated systems testing to meet the requirements of CAN/ULC S1001 Integrated Systems Testing of Fire Protection and Life Safety Systems. The consultant shall ensure that the relevant tests are included in the contract document and results/reports are collected at substantial completion.
- .4** Refer to [Section 4, Division 01 91 00 - Building Commissioning](#) for details.

## 2 Products

### **.1 AIR COMPRESSORS**

- .1** Supply and install air compressors, ULC approved for the dry sprinkler systems and complete with low pressure switch, starter and transformer for low voltage wiring to pressure switch..
- .2** Compressors to be sized in accordance with the requirement of NFPA Standard, for capacity as determined by hydraulic calculation design of dry sprinkler systems.

### **.2 DRY PIPE VALVES**

ULC listed dry pipe valve to be iron body, bronze/galvanized trim, complete with quick opening device if needed, and all accessories, interconnecting piping and subassembly valves and trims in accordance with NFPA Standard.

### **.3 PIPING**

Piping to be Schedule 40, Schedule 10, Schedule 7 or lightwall threadable pipe. Use threadable fittings for Schedule 40 or lightwall threadable pipes only. Use Victaulic grooved fittings for Schedule 40, Schedule 10 and lightwall Schedule 7 pipes or MegaPress fittings for Schedule 10 to Schedule 40 pipes. Blazemaster PVC pipe may be used if installed in accordance with the ULC listing, NFPA Standard and Authority Having Jurisdiction.

### **.4 PRESSURE GAUGES**

Provide pressure gauges at the following locations and additional gauges as required by NFPA, Authority Having Jurisdiction and system configuration;

- .1** Water entry valve station both upstream and downstream of backflow preventer.

- .2 Upstream and downstream of pumps.
- .3 At top of fire standpipe and sprinkler risers.

## .5 FIRE DEPARTMENT CONNECTIONS

Provide Siamese or Storz type fire department connection. The Siamese connection shall consist of a rough brass body with polish swivels and polished chrome caps with chains. The Storz connection shall include a powder coated inlet connection with a cap and chain on one side and female pipe thread on the other side. The fire department connections shall be ULC listed and approved by the local fire department. Ensure that tread pattern matches local fire department hose connections.

## .6 STANDPIPES

Provide fire standpipe system within the building, as required by the building code, NFPA Standard and Authority Having Jurisdiction. Piping shall be concealed except for standpipe risers located within stairwells or piping within mechanical rooms and parkades.

## .7 SPRINKLER HEADS

- .1 Sprinkler heads within residential suites, corridors, and common areas shall be “residential” type sprinklers except where prohibited by NFPA Standard or the sprinkler listing.
- .2 Provide quick-response heads where required by NFPA Standard.
- .3 Provide standard brass upright or pendant heads on 25 mm (1") connection for unfinished areas. Provide mechanical protection in areas susceptible to damage (mechanical rooms, low headroom, etc.).
- .4 Provide **recessed sprinkler heads** in all suites and finished common areas used by residents, in homeless at-risk projects.
- .5 Provide dry heads, standard brass upright or pendant, for areas subject to freezing.
- .6 Provide high temperature fast response sprinkler heads rated at 150°C protected with wire guards for a bed bug heat treatment room and vestibule.
- .7 Provide spare sprinkler heads in a steel cabinet as required by NFPA Standard.

## .8 SPRINKLER SYSTEM ZONING

Provide zoning in accordance with NFPA Standard and in accordance with the requirements of Authority Having Jurisdiction. As a minimum, provide separate zones for each floor and the attic. Valve assemblies to be in accordance with NFPA Standard, shall be accessible and provided with a monitored shut off valve and flow alarm switch connected to the fire alarm panel.

## .9 VALVES

All valves to be Underwriter’s Laboratories Canada listed for minimum 1200 kPa (175 psi) working pressure on sprinkler and standpipe systems (Note: Maximum allowable working pressure is 1140 kPa (165 psi) for the sprinkler system and 1200 kPa (175 psi) for the stand pipe system). All valves inside the building must be provided with supervisory switches connected to the fire alarm panel.

### **.10 FIRE EXTINGUISHERS**

Provide Fire Extinguishers in accordance with NFPA-10 Standard with Fire Extinguisher type to suit building area hazard. Location of fire extinguishers is subject to approval of the local fire department. For commercial kitchen application, provide ULC listed low air volume hood with demand ventilation (control) system and integral fire suppression system as required by current codes and the requirements of the Authority Having Jurisdiction at the time of installation.

### **.11 BACKFLOW PREVENTER**

Main fire line shall be separated from the potable water source by a ULC listed double check valve backflow preventer.

### **.12 FIRE PUMP**

- .1** The Consultant must verify the available flow and pressure in the municipal water main to determine basis for the design of the sprinkler/standpipe system. This information might be available from the local Engineering Department or might require arranging for a water flow test at the closest fire hydrant
- .2** The Consultant shall obtain sufficient fire flow/pressure data to determine if a fire pump is or is not required for the project.
- .3** If the Consultant determines that there is no sufficient fire flow/pressure available to maintain a minimum residual pressure at the highest point in the building to satisfy the sprinkler flow requirements, a fire pump shall be provided for the project. The fire pump shall be designed in conformance with NFPA-20 Standard.

## **3 Execution**

### **.1 INSTALLATION**

- .1** Use materials that bear the manufacturer's identification mark in addition to all other markings required by the specifications.
- .2** All tests and adjustments required by NFPA Standards shall be performed. Copies of completed Aboveground and Underground Contractor's Material and Test Certificates shall be delivered to the consultant at least five (5) full working days prior to the building takeover inspection.
- .3** Supply and install cabinet containing spare sprinkler heads corresponding to the types and temperature ratings as installed in the building. The cabinet shall be located as indicated on site and shall include sprinkler wrench suitable for each head type. Provide a minimum of six spare heads for each type of head installed.
- .4** Ensure that the sprinkler system is protected from freezing in accordance with the requirements of the Authority Having Jurisdiction. The dry sprinkler system shall be installed in unheated attic and parkade areas (Note: for buildings designed to the requirements of NFPA-13D or NFPA-13R, sprinklers in the attic spaces are not required). Stand pipe distribution piping located in unheated areas shall be insulated and provided with electric heat tracing monitored by the fire alarm panel.

- .5 Fire extinguisher cabinets shall be installed no more than 1219 mm (4'-0") above the floor. Fire extinguishers shall be provided in recessed enclosures in corridor walls. Do not compromise required fire separation or rating. Fire extinguishers to comply with NFPA Standard, BC Building Code and the Authority Having Jurisdiction.

## **.2 EARTHQUAKE PROTECTION**

- .1 Provide seismic bracing in accordance with the requirements of the BC Building Code, CSA S832 Standard and NFPA Standards.
- .2 Provide Letter of Assurance from Seismic Professional Engineer registered in BC confirming that the design and installation of seismic restraints meet all regulatory requirements.

## **.3 PERFORMANCE**

- .1 The construction documents shall indicate the location of sprinkler heads in finished areas, main piping distribution and location of all supervised valves and flow alarm switches. The Sprinkler Contractor shall be responsible for the final layout of the sprinkler system and submission of shop drawings complete with hydronic calculations for review by the Consultant and approval by the Authority Having Jurisdiction. Sprinkler shop drawings shall be stamped/signed by Supporting Professional Registered in BC and issue Schedule S-B and S-C upon complete.
- .2 The Sprinkler Contractor shall provide the hydraulic design for the system in accordance with NFPA Standard and, where applicable, code equivalency requirements.
- .3 Hydraulic calculations are to include for 20% more in volume than the total sprinkler demand and 10% more pressure at the base of the riser is required by Authority Having Jurisdiction and NFPA Standard.
- .4 Hydraulic calculations and working drawings to be presented in a manner acceptable to the Authority Having Jurisdiction. The Sprinkler Contractor to note and confirm compliance with all requirements of NFPA Standards, including which edition of NFPA Standard was used in the design and, where applicable, code equivalency requirements.
- .5 The Sprinkler Contractor shall test the system flow to provide the final data for the sprinkler system design and shall report the results of the flow test to the Consultant.

**End of Section**

# 22 00 00 - Plumbing

## 1 General

- .1 Provide complete sanitary and storm drainage systems, including clean-outs, manholes, catch basins, piping, pumps, sumps, fixtures and all other equipment connected to local drainage. Avoid sump pumps for storm and sanitary wherever possible. If pumps are needed, route only that drainage through the pump that cannot be drained by gravity. Design, construct and install storm and sanitary drainage systems to conform to applicable codes and good engineering principles. The plumbing system shall be designed to comply with the requirements of the BC Plumbing Code and Local Authority Having Jurisdiction.
- .2 Insulate all plumbing system components including, but not limited to, hot water mains, recirculation and run outs to comply with ASHRAE 90.1 - 2010 and National Energy Code for Buildings (NECB) 2011. Provide a continuous vapour barrier for all cold water and chilled water piping to prevent condensation.
- .3 Low water consumption plumbing fixtures shall be specified, e.g., water closets, sink and lavatory faucets, and shower heads.

### .4 QUALITY ASSURANCE

- .1 All equipment shall be installed by qualified contractors licensed and regularly engaged in the installation of plumbing systems. Refer to [Division 23 00 00 HVAC](#) for details on tradesmen qualifications.
- .2 In order to provide a better quality assurance of the mechanical design, BC Housing may retain an independent consultant to provide a design review at the end of the design development stage. The mechanical Engineer of Record will be asked to provide all relevant information for the independent review and will be requested to address any potential design issues and comments brought up by the reviewer before moving to next design stage.

### .5 WARRANTY

Provide full 2 years warranty for all labour and materials along with full 2 years of service contracts for projects under Part 3 buildings for new construction and as appropriate for renovation projects for overall mechanical systems including control systems. For Part 9 projects, provide one year warranty with full one year of service contracts.

For service contracts refer to [Division 23 00 00 HVAC](#) for detail.

### .6 MANDATORY MECHANICAL SYSTEM COMMISSIONING

- .1 All BC Housing projects shall require mechanical, HVAC, and plumbing systems commissioning by an independent commissioning provider. Refer to [Section 4, Division 01 91 00 - Building Commissioning](#) to establish the commissioning requirements for the project and activities for the mechanical contractor.

- .2 BC Housing or Owner will conduct an independent commissioning provider (CxP) as outlined in [Division 01 91 00 - Building Commissioning](#) based upon the local re-zoning by-laws, project classification and size/complexity of the building. This should not replace the consultant, contractor, their sub-contractors or their own 3rd party agency's responsibilities in the contract documents. The contractor must submit the mandatory mechanical testing reports for pre-functional and equipment strat-up before the CxP performs the system functional testing and all other commissioning activities.
- .3 Refer to [Section 4, Division 01 91 00 - Building Commissioning](#) and [BC Housing Building Commissioning Guidelines](#) for details.

## .7 POTABLE WATER SYSTEM

- .1 Street pressure system is to be used whenever possible. If the following conditions apply, install a booster system:
  - .1 minimum street water pressure, discounted 35 kPa (5 psi) for future unknowns, does not meet all building requirements or,
  - .2 if the street pressure is below 276 kPa (40 psi).
- .2 Install a pressure reducer if the street pressure is greater than 551 kPa (80 psi).
- .3 Provide an approved double check valve backflow preventer as per CSA and code requirements.
- .4 Provide Reduce Pressure Backflow Preventer for water main for site.
- .5 Where a permanent irrigation system is approved for the project by BC Housing, provide. Reduce Pressure Backflow preventer for irrigation system.
- .6 Water supply piping in outside walls is not permitted. Route piping in a furred-out chase completely outside of the exterior wall. Do not embed piping in the wall insulation.
- .7 Avoid drainage piping in outside walls. If unavoidable, ensure that the exterior wall insulation is between the pipe and the exterior wall, that the pipe is not embedded in the insulation and that the R value of the insulation complies with the required value for the assembly. Use EPS or polyisocyanurate insulation if the pipe must be installed in an exterior wall stud space.
- .8 Provide a shut off for each riser in apartment buildings. Valves 57 mm (2") and less in diameter must be ball valves. Shutoffs to be easily accessible.
- .9 Provide a shut-off valve for each unit. Provide a prefabricated, keyed metal access panel. Shut offs to be easily accessible.
- .10 Provide pre-manufactured water hammer arrestors as per BC Building Code (Sentence 2.6.1.9.) and at the termination of all hot and cold water branch lines serving groups of fixtures or any fixture with a solenoid valve such as a dishwasher or clothes washer. Field fabricated arrestors are not permitted.
- .11 Provide plastic sleeves for pipes through concrete 25 mm (1") larger than pipe, packed with insulation and smoke seal per code.
- .12 Provide frost free hose bibs c/w automatic draining vacuum breakers/backflow preventer at the following locations:

- .1 garbage enclosures
  - .2 main entry
  - .3 near landscaped areas – provide minimum one per building face; maximum spacing 30.5 m (100'-0")
  - .4 locate hose bibs to avoid conflict between hose and sidewalks
- .13 Provide individual curb shut-offs to each building and a main water shut-off within each building. Provide a curb stop and key.
- .14 Provide a total building water meter. Where applicable, provide separate water sub-meters to areas with separate lease agreements. Confirm requirements for water sub-metering with BC Housing.

## .8 DOMESTIC HOT WATER SYSTEMS

- .1 Hot water temperature must not exceed 49°C (120°F) at points of use by tenants. Hot water storage shall not be below 60°C (140°F) to control the propagation of Legionella bacteria. On central domestic water heating systems provide hot water recirculation system. Care shall be taken to minimize dead legs to outlets (2 m is the maximum allowable).
- .2 Provide hot water distribution to common kitchen areas and for janitor sinks at 60°C (140°F).
- .3 Where low temperature pre-heating storage tanks are utilized, provide means of automatically re-heating water to 60°C (140°F) for a period of 1-hour every 24 hours for sanitation purposes.
- .4 All residential showers shall be provided with **pressure independent valves (pressure balance valves) with temperature limit stops**. All residential bathroom and kitchen faucets shall be provided with temperature limit stops. The shower valves and faucets shall be set to maximum hot water temperature of 49°C (120°F).
- .5 **Pressure balance valves with temperature limit stops for residential showers, and temperature limit stops only for faucets is acceptable, as a minimum requirement, for low anti-scalding risk tenants such as Family Housing. For higher anti-scalding risk tenants including shelters, wheelchair accessible units, assisted living, group homes and residential care homes, the domestic hot water system shall be provided with either a central thermostatic mixing valve or individual in-suite thermostatic mixing valves installed at the distribution manifolds.**
- .6 Boiler and Storage Tank System – the use of a boiler and storage tank system is the preferred hot water system for projects. Boilers used as a main source of hot water heating shall be separate from the domestic hot water system. Where boilers are used as a supplementary or backup source of heating only, it is acceptable to utilize heating boilers for generation of domestic hot water.
- .7 If a solar hot water system is specified, install according to the guidelines from CanSIA's Solar Ready program and the CAN/CSA-F383 Installation Code for Solar Domestic Hot Water Systems and comply with BC Regulation 163/2013.
- .8 **Avoid domestic water system piping under the concrete slab or topping, due to future maintenance. If unavoidable, any in-slab distribution shall be contained within the residential suite.**

## .9 DRAINAGE SYSTEMS

- .1 Locate roof drains to minimize number of stacks from roof to storm sewer. Balance this requirement with the need to provide minimum 2 way drainage to roof areas.
- .2 Provide floor drains with trap primer in common laundry.
- .3 Floor Drains for:
  - .1 Sheet vinyl flooring shall be dura-coated cast iron body with bottom outlet, combination invertible membrane clamp and adjustable collar with polished nickel bronze strainer and complete with trap primer connection.
  - .2 Ceramic tile floor shall be dura-coated cast iron body with bottom outlet, combination invertible membrane clamp and adjustable collar with "Type Y" polished nickel bronze square strainer with stainless steel screws and complete with trap primer connection.
- .4 Provide a membrane under any ceramic tiled shower areas and clamp the membrane into the membrane clamp of the floor drain. The membrane shall be in accordance with Part 7 of the BC Building Code.
- .5 Provide a bi-level drain in suite areas if required by Authorities Having Jurisdiction. Coordinate with other trades for provision of waterproofing membrane under the concrete topping and/or resilient flooring subtrade for installation of clamping drain.
- .6 Utilize cast iron DWV piping for all vertical drainage risers, horizontal drainage over areas with noise sensitivity (especially bedroom and sleeping areas) and for all drainage in parkade areas. Non-metallic DWV can be considered in less noise sensitive areas, but the drainage layout shall be reviewed and commented on by an acoustic consultant. Waste stacks and rain water leaders (RWL's) must not touch the structure and should be resiliently supported at floor penetrations on neoprene pad isolators sized for a minimum of 3mm of static deflection.
- .7 Provide a drainage system for covered or underground parking areas. Comply with the City of Vancouver Bulletin 2008-007-EV/PL Parkade Drainage Treatment System.

## .10 COMMON LAUNDRY

Contractor to provide plumbing rough-in for tenant laundry equipment, including a utility sink.

# 2 Products

## .1 POTABLE WATER PIPING

- .1 Use Type L copper pipe for all hot and cold water supply piping.
- .2 Use Type K copper pipe on hot water recirculation piping when recirculation system is used.
- .3 Use only lead free solder in copper piping systems.
- .4 Non-metallic pipe and fitting systems, i.e. cross linked polyethylene (PEX), chlorinated polyvinyl chloride (CPVC), polypropylene (PP-R) shall be accepted as alternates for potable hot and cold water mains and risers applications as per the BC plumbing code 2012 Division B - Appendix A.

It is the responsibility of the consultant to ensure they are suitably specified and detailed to comply with BCBC 2012 Sentence 3.1.5.16.(1) combustible piping materials in buildings required to be of noncombustible construction with regard to flame spread rating and smoke developed classification.

The Consultant shall coordinate specifications and detailing for the installation of the system and confirm that all components meet the local authority's requirements including referenced standards, fire stopping and STC rating.

The thermal expansion and supports shall be as per the pipework manufacturers requirements.

- .5** The Consultant shall submit written confirmation of approval for the specified system from the authority having jurisdiction and, where applicable, a copy of the approved equivalency, to BC Housing prior to approval of the construction documents.
- .6** The potable water system shall be designed to ensure that the maximum design temperatures and pressure of the piping material are not exceeded. Provide pressure reducing valves and controls if required to ensure that approved pressures and temperatures are not exceeded.
- .7** The Contractor shall provide a 25 year manufacturer's warranty on all piping, in line fittings and domestic water distribution manifolds which includes coverage for consequential damage.
- .8** Cross linked polyethylene (PEX) may be used for potable water piping for in-suite run outs from fixtures to manifold subject to the following conditions:
  - .1** Approved PEX piping systems are acceptable in lieu of copper for in-suite run-outs to fixtures provided the potable water piping distribution is contained within an individual residential suite. The PEX piping and fitting system shall conform to CSA B137.5 and shall be approved for potable water use.
  - .2** Distribution manifolds shall be manufactured of brass or copper, approved for use in the system by the piping manufacturer and covered by the manufacturer's 25 year warranty.
  - .3** In-line fittings shall be approved for use in the system by the piping manufacturer and covered by the manufacturer's 25 year warranty.
  - .4** It is not recommended to have the potable water pipes to be installed in the concrete slab due to future maintenance. Where PEX potable water piping is installed in structural slabs, a larger diameter polyethylene sleeve is required. Polyethylene bags are not acceptable.
  - .5** PEX potable water piping shall not be installed in slabs used for radiant heating/cooling, due to potential problems with heat gain in the DCW and conflict with the heating pipe layout. PEX piping shall not be exposed to UV prior to or during installation and must be warranted for a minimum of 30 days exposure.
  - .6** Protect piping and manifolds from entry of contaminating material by installing suitable plugs in all open ends until installation. Where possible, connect pipes to assembled manifolds to eliminate possibility of contaminants.
  - .7** Provide lockable metal access covers for all manifold locations.
  - .8** The Contractor shall submit the following for review and acceptance by the Consultant prior to installation: specifications for all components of the system, confirmation of compliance with referenced standards, confirmation of municipal approval, confirmation in writing from the manufacturer that the installer is trained and approved to install the system and a copy

of the manufacturer's warranty.

- .9 All piping shall be installed so that it will in no way be strained or distorted by thermal expansion. Anchors and expansion loops shall be provided where necessary to protect equipment / piping and regulate expansion. This shall be the responsibility of the Mechanical Consultant and Contractor

## .2 FIXTURES

- .1 Provide fixtures of same make, model and colour throughout project.
- .2 All faucets shall meet the American Disabilities Act Guidelines and ANSI A117.1 requirements for the physically disabled.
- .3 Provide aerated low flow fixtures for the bathroom: 2 LPM/0.5 GPM faucet, and 5.7 LPM/1.5 GPM showerhead. Fixtures shall display CSA approval. Refer to [Energy and Environmental Design](#).
- .4 Plumbing fittings shall be to CAN/CSA B125, Plumbing Fittings.
- .5 Plumbing fixtures shall be to CAN/CSA B45, 'General Requirements for Plumbing Fixtures.'
- .6 Vitreous china plumbing fixtures shall be to CAN/CSA B45.1, 'Ceramic Plumbing Fixtures.'
- .7 Enameled cast iron plumbing fixtures shall be to CAN/CSA B45.2, 'Enameled Cast Iron Plumbing Fixtures.'
- .8 Porcelain enameled steel plumbing fixtures shall be to CAN/CSA B45.3, 'Porcelain Enameled Steel Plumbing Fixtures.'
- .9 Stainless steel plumbing fixtures shall be to CAN/CSA B45.4, 'Stainless Steel Plumbing Fixtures.'
- .10 Plastic plumbing fixtures shall be to CAN/CSA B45.5, 'Plastic Plumbing Fixtures.'
- .11 Cartridge shall be brass with ceramic disc and 5 years warranty.

## .3 WATER CLOSETS

- .1 Low Flush Water Closets: Vitreous China, ADA compliant, free standing elongated rim, wash-down bowl, china bolt caps, single flush 4.8 LPF (1.3 GPF), min. 54 mm (2-1/8") fully glazed trapway, and comply with the latest edition Maximum Performance (MaP) testing rated at 1000 gram of waste per flush. Refer to [Energy and Environmental Design](#).
- .2 Water closets shall be closed front with cover seat that shall be rugged, high impacted solid plastic that is highly stain and chemical resistant with stainless steel hardware package and factory-installed top tite hinges.
- .3 Water closets shall be supplied with chrome-plated supply line, escutcheon plate and ball-valve type fixture stop.

## .4 KITCHEN SINKS

- .1 Sinks shall be grade 18-8 stainless steel, **double** bowl counter mounted sink complete with back ledge, self-rimming, sound deadening, mounting kit, strainer, and 89 mm (3-1/2") crumb cup.

Single bowl sinks are acceptable for kitchens in studio units and units in assisted living projects.

- .2 Faucets shall be deck mounted, solid cast brass lead-free body complete with washerless, ceramic drip-free disc valve cartridge, 240 mm (9-1/2") long cast swing spout with vandal-resistant, 5.7 LPM (1.5 GPM) flow pressure compensating aerator outlet, removable brass escutcheon plate, single control metal lever handle, flexible copper supplies and less hand spray (cap provided for non-spray application).
- .3 Where a faucet is installed on a island type counter the faucet is to have a maximum swing of 180 degrees
- .4 Provide temperature limit stops set not to exceed 49°C (120°F) hot water temperature. For project where increased level of anti-scalding protection is required, consider utilizing thermostatic mixing valves.
- .5 **Sink Dimensions**
  - .1 Standard applications: 178mm (7") deep complete with mirror finished rim, satin finished bowl, and 38 mm (1-1/2") tailpiece.
  - .2 Wheelchair accessible applications: 127mm (5") deep , satin finished rim and bowl, and with rear corner 38 mm (1-1/2") tailpiece, located in the back corner. Provide millwork to protect against scalding and contusions. Alternatively, with BC Housing prior approval, an insulated pipe covering that is vandal-resistant, flexible, seamless as per local codes may be permitted.

## .5 AMENITY AREA

- .1 Sink for the recreation area shall be a double bowl, 18-8 grade stainless steel counter mounted sink complete with back ledge. It shall be self rimming, with 89 mm (3-1/2") crumb cup, strainers, sound deadening coating and come complete with mounting kit.
- .2 Faucet shall be deck mounted, and have a solid cast brass lead-free body, washerless, ceramic drip-free disc valve cartridge, 240 mm (9-1/2") long cast swing spout with vandal-resistant, 5.7 LPM (1.5 GPM) flow pressure compensating aerator outlet. The faucet shall also come with a removable brass escutcheon plate, single control metal lever handle, flexible copper and omit the hand spray (cap is to be provided for non-spray application).
- .3 Provide temperature limit stops set not to exceed 49°C (120°F) hot water temperature. For project where increased level of anti-scalding protection is required, consider utilizing thermostatic mixing valves.
- .4 The sink shall be wheelchair accessible.

## .6 LAUNDRY

- .1 Utility sink for the laundry shall be a single compartment, deep bowl, grade 18-8 stainless steel 560mm x 651mm x 305mm (22-1/16" x 25-5/8" x 12") deep counter mounted sink, with back ledge, mirror finished rim, satin finished bowl, self rimming, with crumb cup strainer, 38 mm (1-1/2") tailpiece, sound deadening and mounting kit, 89 mm (3-1/2") crumb cup and strainers.
- .2 Faucet shall be deck mounted, and have a solid cast brass, lead-free body, washerless, ceramic drip-free disc valve cartridge, 240 mm (9-1/2") long cast swing spout with vandal-resistant, 5.7

LPM (1.5 GPM) flow pressure compensating aerator outlet. The faucet shall also come with a removable brass escutcheon plate, single control metal lever handle, flexible copper supplies and omit the hand spray (cap is to be provided for non-spray application).

- .3 Provide temperature limit stops set not to exceed 49°C (120°F) hot water temperature. For project where increased level of anti-scalding protection is required, consider utilizing thermostatic mixing valves.

## .7 JANITOR ROOMS

- .1 The janitor room shall be provide with precast terrazzo floor mounted, mop sink, 610mm x 610mm x 254mm (24" x 24" x 10") deep, and Integral Cast Brass Drain with stainless steel strainer 75 mm (3") outlet.
- .2 The faucet shall be wall mounted, cast brass body, with metal handles, integral vacuum breaker, integral stops, hose end, pail hook and top brace.
- .3 Provide bracket and 915 mm (3') hose with coupling, bumper Guards, 3 stainless steel mop hangers, drain gasket, connection for 75mm (3") pipe, stainless steel back splash panels, on two sides and 'p' Trap.

## .8 BATHTUBS (FAMILY PROJECTS)

Bathtubs must be non-slip, stain resistant, porcelain enameled steel with plug and chain drain, sound deadening, overflow, over-rim spout and cast brass trap. Fiberglass bathtubs are not acceptable. Provide tub spout with diverter and single lever, **pressure independent valve (pressure balance valve) with temperature limit stops set not to exceed 49°C (120°F) hot water temperature.**

## .9 PRE-FABRICATED SHOWER UNIT – FOR ADAPTABLE AND SENIOR TENANT'S SUITES

- .1 One piece, **non-slip gelcoat** shower to minimum 914 mm x 1521 mm (3' x 5'). Includes three grab bars, wall hook and low curb at floor. In lieu of acrylic grab bar install 32 mm diameter, 914 mm long stainless steel grab bar (1-1/4" x 3'). For Renovation project, two or three piece shower unit can be considered, if one-piece cannot be installed due to existing bathroom configuration. Make sure the potential leak sources are sealed properly to prevent water damage.
- .2 Provide single lever, **pressure independent valve (pressure balance valve) with temperature limit stops** set not to exceed 49°C (120°F) hot water temperature. Provide a push button hand-held showerhead and vacuum breaker. Shower heads shall be low flow, limiting water flow to 5.7 LPM (1.5 GPM) or less.

## .10 PRE-FABRICATED SHOWER UNIT – FOR WHEELCHAIR ACCESSIBLE SUITES

- .1 One piece barrier-free, fiberglass or custom non-slip showers for wheelchair accessible suites, to minimum 974 mm x 1586 mm (3' 2-3/8" x 5' 2-1/2"). Includes three grab bars, folding seat, and rollover threshold to maximum 13 mm (1/2"). Conform to recommendations of CSA B651. Provide single lever, **pressure independent valve (pressure balance valve) with temperature limit stops** set not to exceed 49°C (120°F) hot water temperature. For Renovation projects, two-piece shower unit can be considered, if one-piece cannot be installed due to existing bathroom

configuration. Make sure the potential leak sources are sealed properly to prevent water damage.

- .2 Provide a combination stainless steel slide/grab bar with 1778mm (5'-10") long hose, push button hand showerhead and vacuum breaker. Shower heads shall be low flow, limiting water flow to 5.7 LPM (1.5 GPM) or less.
- .3 Confirm with tub/shower supplier that reinforcing or backing is provided behind the tub/shower wall to support the installation of the slide/grab bar.

### .11 LAVATORIES

- .1 Lavatories shall be vitreous china self-rimming lavatory basin with rear overflow.
- .2 Lavatories shall be supplied with chrome single lever washerless faucet with ceramic disc cartridge and temperature limit stops set not to exceed 49°C (120°F) hot water temperature. For project where increased level of anti-scalding protection is required, consider utilizing thermostatic mixing valves.
- .3 Low-flow faucet aerators must be provided for bathroom sinks and any faucet used primarily for hand washing, limiting water flow to 2 LPM (0.5 GPM) or less.

### .12 MANHOLE COVERS AND CATCH BASINS

- .1 Provide manhole covers and catch basins with circular precast sewer cover sections with top sections having eccentric cone or flat slab top type with opening offset for vertical ladder installation. All bolt down applications must have pentagon style heads.
- .2 Provide light duty type manhole and catch basin frames and covers for landscape service and heavy duty traffic type for all other applications.
- .3 Castings to be coated with two applications of asphalt varnish after being sand blasted or cleaned and ground to eliminate surface imperfections.
- .4 Set frame and cover to required elevation on no more than 4 courses of brick. Bricks to be jointed and bonded to frame with cement mortar. Parge brickwork and make smooth and watertight.

## 3 Execution

- .1 Damaged or repaired bathtubs will not be accepted.
- .2 Penetrations through exterior walls must be sealed to the water barrier of the wall assembly using self-adhesive bituminous membrane and/or expanding foam sealant suitably applied to protect from weather penetration. The method of sealing penetration must be acceptable to the building envelope consultant.
- .3 Caulk plumbing fixtures where fixture contacts wall, floor or vanity. Refer to [Division 07 92 00 - Joint Sealants](#), for acceptable products.

**.4 Piping**

- .1** Installation shall comply with the manufacturer's specifications and be carried out by a trained installer, certified by the manufacturer.
- .2** Insulate all domestic hot cold and recirculation piping with preformed glass fibre type insulation. Insulate all domestic hot and recirculation piping as required ASHRAE 90.1 - 2010 and NECB 2011. PEX piping in slab is not required to be insulated but shall be sleeved.
- .3** Provide supports for pipes. Maintain required grading by adjustment; allow for expansion and contraction and produce a neat appearance. Design supports to suit loading and services. Prevent undue stress to structural members. Supports must secure pipe and prevent vibration.
- .4** For all copper horizontal piping use wrought clevis hangers 25 mm (1") larger than pipe diameter suitable for vertical adjustment, isolated from pipe with plastic tape.
- .5** Provide access panels to concealed valves and clean-outs. ULC rating required in rated assemblies.
- .6** Install escutcheon plates at piping penetrating wall and at exterior hose bibs.
- .7** Provide a metal access panel for all hose bibs with concealed isolating valves.
- .8** Drain connection for a water closet shall be minimum 100 mm (4") diameter.

**.5 SEISMIC RESTRAINT**

- .1** Seismic restraint must be provided for all mechanical equipment and accessories including attachment to structural members where required by code.
- .2** Letter of Assurance from Seismic Engineer on commencement of design and completion of field review must be provided where required.

**.6 ACOUSTICAL CONSIDERATIONS**

- .1** Consultant to review acoustic requirements and incorporate or revise the following standards to achieve required STC ratings:
  - .1** Plumbing (including RWL's) shall be installed without direct contact to drywall or studs. Position risers/wastes in centre of wall chase to meet this requirement. Where concrete penetrations (cans) are not centred on plumbing chase advise site superintendent.
  - .2** Oversize sleeves through structure. Use firestopping and smoke seal in accordance with [Division 07 80 00 - Firestopping and Smoke Seals](#). Support plumbing at floor level only.
  - .3** Where risers serve suites on each side, provide individual take-offs from riser. Do not service two suites through single "T" connection off riser. Minimum size for end of riser is 19 mm (3/4") for 13 mm (1/2") takeoffs on each side. Provide premanufactured water hammer arrestor at all riser terminations and at appliances with solenoid activated valves.
  - .4** To avoid contact with studs and drywall, orient all pipe clamps parallel to walls. Only use plastic pipe clamps on 13 mm (1/2") diameter supply piping with suite being served. Attach wing back elbows, shut off valves, faucets, etc., to separate wood plates in separate rows of studs in party walls. Provide clearance and use resilient (fire) caulking where piping passes

through party walls and floors. The intent of these requirements is to minimize bridging of wall by plumbing system.

- .5** Where supply pipes serve suites above, suspend piping from hangers from the floor above. On supply piping, use oversized hangers/straps and include layer of resilient, 13 mm (1/2") thick neoprene, pipe insulation between hanger and insulated pipe, with metal shim to distribute load (20% maximum compression). Fibreglass pipe insulation is also acceptable provided manufacturer's loading criteria are met.
- .6** Where main wastes are offset, isolate pipe clamp at offset floor using 6 mm (1/4") thick 60 durometer neoprene pads. Cut pads to size of clamp with clearance on each side, e.g., about 51 mm x 75 mm (2" x 3"). Load pads evenly not exceeding 4140 kPa (600 psi). If necessary, provide trowel finish topping under pads if concrete floor is not smooth. Provide layer of resilient, 13 mm (1/2") thick neoprene pipe insulation (20% maximum compression) in oversize pipe clamps for first two hangers after bend.
- .7** Maintain minimum 13 mm (1/2") clearance between pipes and studs, electrical conduit, or other pipes. If clearance is minimal, use resilient neoprene insulation to avoid contact. This requirement is to avoid rattling between pipes.
- .8** Do not use foam spray-on products for insulation.
- .9** Approval of the plumbing system is required before insulation and drywall work is started. Do not commence final boarding until plumbing has been reviewed for clearance.
- .10** Submit shop drawings showing equipment and installation details to isolate equipment. Supplier to visit site as necessary to ensure an acceptable installation.
- .11** Isolate pumps and other equipment which may generate vibration on Mason BC neoprene isolators or neoprene hangers, unless otherwise specified. Immediately upstream and downstream of all 3500 rpm pumps, provide flexible pipe connectors (multi-layered nylon tire cord fabric reinforced with EPDM cover and liner). Provide shut-offs to allow replacement of connectors without draining system.
- .12** Isolate piping for 10 m (32'-10") upstream and downstream of all pumps and other equipment generating vibration. Isolate main water supply pipe from street supply to 10 m (32'-10") downstream of booster pump using thermal insulation of neoprene hangers. Use oversize clevises outside insulation with high density block rated for pipe weight pipe support insulation. Do not use rigid ceramics, etc. Where pipes pass through walls, avoid rigid contact and provide continuous insulation. If fire rating is necessary do not grout. Use soft fireproof caulking.
- .13** Isolate all vibrating equipment, pumps and piping in mechanical rooms as described above. In penthouses, isolate boilers, hot water tanks, etc. on rubber pads (Durometer 50 with a max 15% deflection per 50mm x 50mm at 80kg/s) pads with hold down bolts and grommets.
- .14** Use cable restraints only on isolated piping and equipment. Do not bridge isolation elements.
- .15** Avoid all contact between plumbing and framing/drywall. Frame all plumbing chases and drop ceiling plumbing cavities at least 25 mm (1") larger than the maximum insulated collar

size of the piping in the cavity. Loosely insulate cavity with R8 or R10 Fibreglass Home Insulation on each side of pipe. Avoid compression of the insulation between piping and drywall. Where plumbing chases are in bedrooms or living rooms, provide two layers of drywall.

- .16 Where bathrooms/kitchens occur above critical spaces such as bedrooms/living rooms, provide suspended ceiling consisting of framing spanning between walls and two layers of drywall with R10 insulation in cavity. To avoid rigid connection of metal framed walls to kitchen/bathroom floors above, include deflection header detail in wall framing incorporating interlocking tracks with isolating tape between flanges 5 mm x 25 mm (3/16" x 1") standard tape. Ensure no contact of any drywall/framing to plumbing and do not compress insulation under pipes.

**End of Section**

# 23 00 00 - Heating, Ventilating and Air Conditioning

## 1 General

The HVAC systems in multi-unit residential buildings more than three-storeys shall be designed to meet all applicable requirements of the valid edition of ASHRAE Standard 90.1-2010 “Energy Standard for Buildings except Low-Rise Residential Buildings” and the BC Building Code or Vancouver Building By-law for Part 3 buildings, including all additional re-zoning and energy by-law requirements of the Municipalities Having Jurisdiction for Part 3 buildings.

Multi-family buildings of three storeys or less shall be designed to meet all applicable requirements of the BC Building Code or Vancouver By-law for Part 9 buildings, including all additional re-zoning and energy by-law requirements of the Municipalities Having Jurisdiction for Part 9 buildings.

Consult the re-zoning and energy by-law requirements before establishing the performance criteria for the project. Projects are required to exceed the minimum mandatory requirements and achieve higher energy efficiency and sustainability targets where BC Housing requirements are more stringent.

Unless governed by more stringent local by-laws, all new projects shall meet the minimum building and energy performance targets as stated in [Energy and Environmental Design](#).

Passive design strategies and a better performing building envelope shall be chosen ahead of utilizing complex and difficult to operate/maintain HVAC systems. The strategies of harnessing solar radiation and capturing internal gains for heating, and utilizing mechanical ventilation overnight to cool the warm building structures should be considered. Refer to [Energy and Environmental Design](#).

BC Housing is committed to achieving optimal energy performance on equipment and materials that are specified for our existing buildings and in new developments. As such, BC Housing is committed to selecting energy efficient materials and securing all rebates and incentives associated with these energy efficient choices. The Consultant is to ensure that any of these applicable programs are included and captured in all projects.

Designing and specifying material and/or equipment must account for local servicing availability and accessibility of parts for future maintenance and replacement.

Energy Step Code requirements, including maximum Thermal Energy Demand Intensity (TEDI) and Total Energy Use Intensity (TEUI), as defined in [Section 2 Energy and Environmental Design](#), shall be used as targets for meeting Building and Energy Performance. Strategies for meeting these targets shall be identified and verified through a mandatory building energy modeling. Energy modeling shall comply with requirements of the current Provincial Energy Step Code and the City of Vancouver Modelling Guidelines.

Refer to [Appendix C](#) for meeting higher Step Code targets through efficient mechanical design.

### .1 QUALITY ASSURANCE

- .1 All heating, ventilating and air-conditioning systems must be designed and inspected by a professional mechanical engineer registered in the Province of B.C.
- .2 Only tradesmen holding valid Provincial Trade Qualification Certificates can be employed

on the project. Tradesmen shall only perform work that their certificates permit. Apprentice tradesmen shall work under the direct supervision of an experienced journeyman tradesman. Apprentice-to-Journeyman Ratio should not exceed 3:1 on site and shall be recorded regularly as a proof of compliance. As required, installers must be trained and certified by system and equipment manufacturers to conform to warranty provisions.

- .3 In order to provide a better quality assurance of the mechanical design, BC Housing **will** retain an independent consultant to provide a **mechanical peer** review at the end of the design development stage. **On the larger projects this might be followed up by a second review at the 50% construction documents stage.** The mechanical Engineer of Record will be asked to provide all relevant information for the independent review and will be requested to address any potential design issues and comments brought up by the reviewer before moving to next design stage **or tender.**

## **.2 WARRANTY**

- .1 Provide full 2 years warranty for all labour and materials along with full 2 years of service contracts for projects under Part 3 buildings for new construction and as appropriate for renovation projects for overall mechanical systems including control systems. For Part 9 projects, provide one year warranty with full one year of service contracts.
- .2 The service contracts are to follow the manufactures recommended annual maintenance recommendations and running inspections throughout the service terms. They shall include one major annual maintenance visit and a minimum of three running inspections each year. All findings and work completed shall be recorded in a report format and issued to the owner.
- .3 Consideration should be given to further extended warranties on all products in northern and more remote regions of the province.

## **.3 MANDATORY MECHANICAL SYSTEM COMMISSIONING**

- .1 All BC Housing projects shall require mandatory mechanical, HVAC, and plumbing systems commissioning by an independent commissioning provider. Refer to [Section 4, Division 01 91 00 - Building Commissioning](#) to establish the commissioning requirements and activities for the mechanical contractor for the project.
- .2 The commissioning of the mechanical, HVAC, and plumbing systems is the responsibility of the mechanical contractor. At a minimum, the mechanical contractor is required to hire an independent testing and balancing (TAB) agency to meet contract requirements.
- .3 The consultant shall consider the local re-zoning and building commissioning by-law requirements, Owner's 3<sup>rd</sup> - party commissioning requirements, project size and complexity of the systems to establish the commissioning activities for the contractor in the project. The consultant will consult with the Owner or BC Housing at early development phase for the commissioning option as outlined in [Division 01 91 00 - Building Commissioning](#) and [BC Housing Building Commissioning Guidelines](#).
- .4 BC Housing or Owner will choose the commissioning option and hire an independent commissioning provider (CxP) as outlined in [Division 01 91 00 - Building Commissioning](#) based upon project classification and size/complexity of the building. This should not replace the consultant, contractor, their sub-contractors or their own 3rd party agency's responsibilities in

the contract documents.

- .5 Refer to [Section 4, Division 01 91 00 - Building Commissioning](#) for detail options, commissioning activities, systems to be commissioned and commissioning management. For Option 1, 2, 3 the commissioning provider will be hired directly by the Owner to perform the functional testing, oversee owner's demonstration, review of O&M documentation, perform seasonal testing, and warranty reviews. The consultant will include the list of testing (such as pre-requisite tests) in the contract documents for the contractor to perform the equipment start-up and verification process prior the commissioning activities start by the Owner's hired commissioning provider. Option 4, the mechanical contractor will hire their own mechanical commissioning agency to carry out the commissioning tasks.
- .6 Refer to BC Housing Building Commissioning Guidelines.

#### .4 DESIGN REQUIREMENTS

- .1 Design Temperatures (Heating): Design heating systems to maintain indoor temperature of 21°C (70°F). Design outdoor temperatures shall be based on BC Building Code climatic data for the 1% January design temperature for the location.
- .2 Design Temperatures (Cooling): For common areas (excluding corridors), design cooling and ventilation systems to maintain maximum indoor temperature of 24°C (75.2°F). For residential suites, design systems to maintain indoor operative temperatures within 80% acceptable limits as per the current edition of ASHRAE Standard 55 "Thermal Environmental Conditions for Human Occupancy". **It shall be demonstrated that 80% acceptability limits are not exceeded for more than 20 hours per year for any zone.** Design outdoor temperatures shall be based on BC Building Code climatic data for the 2.5% July design temperature for the location.

Unless addressed by implementing passive design strategies, provide **full** mechanical cooling for the amenity / office areas in the Lower Mainland, Vancouver Island, Northern Interior and North Regions, and provide **full** mechanical cooling for the amenity / office areas and residential suites in the Southern Interior Region. Where mechanical cooling is required, window mounted air conditioning units are not permitted.

- .3 Take into consideration project specific factors such as climatic data, microclimate conditions, building envelope thermal resistance, orientation, glazing area and other relevant factors that affect heat gain to determine heating and cooling requirements for the project and to ensure compliance with the Design Temperature performance requirements **and to avoid summer overheating, especially for the south and west facing residential apartments.** Implementing the passive design strategies, as per [Energy and Environmental Design](#), shall be considered to reduce requirements for heating and mechanical cooling.
- .4 Take into consideration redundancy in the design of the mechanical systems. When centralized mechanical systems serve multiple dwelling units a failure of equipment shall not cause a total failure of that system. i.e. provide multiple circulation pumps, provide multiple boilers, multiple hot water tanks etc.

#### .5 VENTILATION

- .1 Design of ventilation systems shall comply with the requirements of ASHRAE Standard 62-2001

“Ventilation for Acceptable Indoor Air Quality” except Addendum N as referenced in the BC Building Code and Vancouver Building By-law.

- .2 Ventilation of residential suites shall comply with the requirements of Part 9 “Housing and Small Buildings”, Section 9.32 “Ventilation” of the BC Building Code and Vancouver Building By-law. This applies to all Part 9 and Part 3 buildings.

## **.6 CONTROLS**

- .1 Where applicable, provide a Direct Digital Controls (DDC) system to control and monitor the mechanical systems and to maintain building performance to the desired comfort levels. The DDC system shall be non-proprietary and control and monitor all main equipment and temperature of all common areas.
- .2 Where the DDC system is used, make sure the following requirements are met:
  - .1 All system controllers must be BACnet and BACnet testing laboratory tested and certified. There shall be at least one BACnet Building Controller (B-BC) device profile on the site for connection to the internet and OWS (Operator’s workstation) via BACnet IP. All mechanical equipment including individual smaller equipment (i.e. RTU’s, fancoils, etc.) shall be controlled by a BACnet Advanced Application (B-AAC) level controller. Zone level control may be either a BACnet, B-AAC controller or a BACnet Application Specific controller (B-ASC). A B-ASC must meet the local controller BACnet trending requirements specified within this specification. Direct trending of points from a B-ASC or B-AAC to a higher level controller B-BC via network polling is not acceptable.
  - .2 The system design should take into account the regional consideration, local availability of servicing and accessibility of the equipment, capacity of the operator to effectively maintain and use the equipment and cost associated to operate and run the facility. Provide a list of preferably minimum three contractors capable of servicing the controls system and located within the province as a part of the tender submission.
  - .3 The building Owner/Operator shall maintain an internet service with a static IP address to allow connection of the building automation systems via BACnet IP to allow remote servicing and troubleshooting of the controls system. Provide a direct connection between the DDC system and OWS. Each building will have its own operator workstation PC and B-AWS operator workstation software on site and directly connected to the BAS network without the need for firewalls except in the case of BC Housing directly managed buildings. In BC Housing directly managed buildings, the buildings shall be connected to the approved service provider via BACnet IP. BC Housing approval is required and shall arrange for a secure VLAN connection for the BMS network.
  - .4 The successful contractor shall be required to provide applied dynamic graphics and network addressing, connect to the site and arrange historical archiving. The touch-screen user interface must be directly connected to the local area BAS network with a local graphical user interface to allow basic operation of the connected systems.
  - .5 All controls to be clearly labelled, easy to locate and networked together. Detailed network layout with panel locations, network/circuit numbers to be provided by the Controls Contractor.
  - .6 All field hardware points, weekly schedule status, setpoint variable status, schedule shall be trended in a BACnet trend log resident on the host controller. All points associated with

any mechanical equipment shall reside on one controller. Sharing points across multiple controllers for a single piece of equipment is not acceptable. All mechanical equipment status shall be placed in an accumulated runtime log. All hardware and software points shall be trended with 5 minute trend intervals.

- .7** Each controller must have a minimum trend sample buffer of at least 300 samples per BACnet object trended on board the controller and communicate with the archiving software/appliance as required to allow storage of this data long term (minimum 4 years). The operator must be able to view a trend log or multi-trend through the B-AWS software on his desktop seeing active point direct from the controller and being able to scroll backward in time seamlessly while viewing the trends from active points to archived points.
- .8** Provide a PC (or combined PC with B-AWS) with operating software, historical data archiving software or an embedded archiving appliance with integral software sized to collect trend log data on an ongoing basis automatically directly from the building automation network and communicate directly with the B-AWS workstation for trend log displays for a minimum of 4 years of data from all trend logs on site.
- .9** Provide automatic fault detection and analytics and system operator use reporting software and reports utilizing the building automation system trend logs and controller databases be employed from the start of warrantee and through the full warranty year. The Owner may or may not choose to continue the services past the warrantee year. An alternate price to continue this service can be requested at the time of bid. The resulting reports shall be provided to the client's designate representative to assist in identifying mechanical, electrical and/or control systems issues while in warrantee. The Consultant should identify DDC system inputs and outputs in the building that require fault detection routines. Provide automated reports identifying these instances on a quarterly basis. In addition, provide an executive summary report to identify and prioritize the most critical instances that would be recommended to be repaired or investigated further.
- .10** Provide a key performance indicator report to compare zone control performance to allow the client to focus their maintenance resources on the worst performing zone for maintenance.
- .11** A completely engineered and commissioned graphics package shall encompass all input/output points of the DDC systems. It shall include graphics of the floor plans showing locations of all space sensors and graphics of all major mechanical equipment and systems indicating status and operating points and setpoints. Graphics shall display a clear, accurate and complete overview of all mechanical plant systems. Overviews shall be segmented to provide detailed views of the individual system components. The software licence shall include graphics viewing and program editing options.
- .12** The Operator shall be trained in using and operating the DDC System as a part of the commissioning process and during the extended service and maintenance contract provided
- .13** The Controls Contractor shall be a recognized firm regularly employed in the engineering and installation of the DDC systems. The Controls Contractor and the controls manufacturer are subject to the approval by the Consultant and BC Housing. Acceptable control systems: Delta Controls, Automated logic or approved equal by Owner and Consultant. The network will be BACnet IP and/or BACnet MS/TP only.

## 2 Products

### .1 HVAC SYSTEMS

The HVAC systems shall meet the requirements of [Section 1 - Building and Energy Performance, Mechanical and Electrical Systems](#) and [Energy and Environmental Design](#).

### .2 HEATING SYSTEMS

The heating system and its selection is the responsibility of the design team and the Owner / Housing Operator. It shall be selected to suit the building construction and the Energy Performance Targets. The selection of the systems shall take into account system operation and maintenance with the aim of simplicity. The chosen system shall be discussed and explained to the building owner/operator during the schematic design phase. BC Housing and the Owner / Housing Operator shall provide the signoff for the conceptual design prior to the commencement of the working drawings. This is to ensure that the passive design strategies have been considered and implemented and that the proposed mechanical systems are within the capability of the service team who will operate and run the facility. BC Housing may retain an independent consultant to provide a design review at the end of the design development stage.

For renovation projects, consideration should also be given to the existing equipment, systems and overall condition of the building before selecting the heating system and equipment.

All piping shall be installed so that it will in no way be strained or distorted by thermal expansion. Anchors and expansion loops shall be provided where necessary to protect equipment / piping and regulate expansion. This shall be the responsibility of the Mechanical Consultant and Contractor.

#### .1 Electric Heating

- .1 Utilizing passive design strategies and a better building envelope allows considering use of electric baseboard heaters for heating of residential suites in a majority of new projects in the Lower Mainland and Vancouver Island regions, and for selected projects in other regions. **Utilizing electric baseboard heaters can be combined with partial mechanical cooling provided by central or semi-central Energy Recovery Ventilators (ERVs).**
- .2 Electric baseboard heaters shall be located under windows in bedrooms and living areas so not to interfere with the furniture layout. Avoid installation of heaters in kitchens due to cleaning problems and lack of wall space.
- .3 Electric heaters in residential suites shall be controlled by wall-mounted thermostats. Built-in thermostats are not permitted in residential suites. Thermostats must not be installed in locations susceptible to drafts, direct sunlight or near heat sources. Thermostats controlling electric heaters with 1,500 Watts or more output per one area in a suite shall be programmable thermostats with a setback controls option..
- .4 The mechanical consultant is responsible for sizing electric heaters based on heating load calculations. **Electric baseboard heaters shall be heavy duty commercial construction with a 20-gauge cold rolled steel front cover and brackets to limit vandalism. The mechanical consultant shall coordinate with the electrical consultant for electrical requirements.**

## **.2 Forced Air Heating**

- .1** All furnaces shall be ENERGY STAR® rated high-efficiency condensing appliances with minimum 95% Annual Fuel Utilization Efficiency (AFUE).
- .2** Flue vent and combustion air intake shall be connected directly to the furnace to provided operation with a sealed combustion.
- .3** At least one heating outlet per each occupied room shall be provided and located, preferably, at the floor level. For each floor /dwelling unit there shall be at least one return duct. Do not locate heating ducts under refrigerators or food storage cabinets.
- .4** Each furnace shall be controlled by a wall mounted low voltage programmable thermostat with a setback controls option.

## **.3 Hot Water Boilers**

- .1** All boilers shall be high-efficiency appliances with minimum 94% Annual Fuel Utilization Efficiency (AFUE):
  - ENERGY STAR® rated for 299 MBH and less;
  - Listed on Fortis BC Eligible Commercial Boiler List for condensing boiler with 300 MBH and greater.
- .2** For buildings with multiple residential suites and where boilers are the main source of heating, the boiler plant shall consist of at least two boilers, each sized for a minimum of 60% of the peak heating demand.
- .3** Where possible and practical, utilize a concentric venting system (inner flue exhaust and outer combustion air intake) to increase efficiency by pre-heating intake air and reduce number of envelope penetrations.
- .4** Use of wall-hung low-mass condensing boilers is acceptable and encouraged on smaller projects and where boilers act as a supplementary or backup source of heating only. For larger projects where boilers are a main source of heating, utilizing high-mass boilers without minimum water flow requirements is preferred.
- .5** Boilers used as a main source of hot water heating shall be separate from the domestic hot water system. Where boilers act as a supplementary or backup source of heating only, it is acceptable to utilize boilers for generation of domestic hot water.

## **.4 Hot Water Baseboard Heating**

- .1** Where using low temperature heating water source and to increase efficiency where using condensing boilers, consider utilizing high-efficiency baseboard heaters in lieu of standard heaters with fin-tube elements. The high-efficiency heaters shall be capable of providing high heating output with lower temperature heating water.
- .2** All baseboard heaters shall be provided with a shut-off valve, balancing valve and control valve. Each riser shall have an automatic air vent at the top.
- .3** All bedrooms and a living area in a residential suite shall be provided with individual wall mounted thermostats. Thermostats must not be installed in locations susceptible to drafts, direct sunlight or near heat sources. Thermostats controlling hot water heaters with 1,500 Watts or more output per one area in a suite shall be programmable thermostats with a

setback controls option.

- .4 Consider utilizing a single hot water riser per each suite with in-slab PEX piping distribution from a manifold to all perimeter heaters. The shut-off, balancing and control valves shall be all provided as a part of the pre-assembled manifold.

## **.5 Infloor Heating**

- .1 Provide detailed design information on the drawings for all heating zones including, but not limited to, room identification, room-by-room heat loss calculations, floor covering insulation value, supply water temperature, design temperature drop, flow rate required per each zone, location of headers and thermostats.
- .2 Supply water temperature in the in-floor loop shall be controlled based on the outdoor temperature reset schedule and maximum allowable floor surface temperature to avoid overheating. Carefully consider run-outs of in-slab piping to individual floor heating loops. Where there is many run-outs located in the interior areas (e.g. corridors), insulate run-out piping with 13mm Armaflex insulation to prevent overheating.
- .3 All installations shall be tested with minimum twice the working pressure, the test shall stay on during the construction period.
- .4 All tubes and recommended fasteners shall be placed as per the manufacturer's specifications. Tube spacing should not exceed 305 mm (12") centre to centre. Each loop must be fastened at each bend, and spacing between each fastener should not exceed 914 mm (3'). The length per loop in a zone for 12.7 mm (1/2") tubing shall not exceed 76.2 m (250').
- .5 No pipework tubing joints are permitted under the slab. . Fittings shall be PEX-A cold expansion type fittings in accordance with ASTM F1960 "Standard Specification for Cold Expansion Fittings with PEX Reinforcing Rings for Use with Cross-Linked Polyethylene (PEX) Tubing". Use of crimped fittings is not permitted. Tubing shall not be placed under any area where a fridge or freezer may be placed, or under any cabinets. The preference is to locate the heating manifolds in common corridor areas. Access shall be provided through lockable access doors from outside of residential suites.
- .6 Topping should be gypsum concrete, or equivalent. Minimum 19 mm (3/4") coverage shall be provided by the topping. Exposed PEX piping shall be protected from UV exposure during construction.
- .7 At exterior walls, tubing should be installed 150 mm (6") on centre up to 1200 mm (4') from the wall.
- .8 All tubing shall be in accordance with ASTM F876 "Standard Specification for Cross-Linked Polyethylene (PEX) Tubing" and shall be provided with an oxygen barrier.
- .9 Solid PVC sleeves shall be provided where tubes pass through concrete floors.
- .10 Provide a separate zone with a control valve and wall mounted non-programmable thermostat for all bedrooms and a living area in a residential suite.
- .11 Each radiant zone shall be equipped with the following:
  - .1 supply and return manifold, complete with a lockable metal access cover

- .2 manual air vent on the return manifold
  - .3 balancing, or isolating valves on each loop, supply and return
  - .4 zone control valve
  - .5 labels, or tags indicating room, and area of service, and length of each loop
- .12 PEX tubing shall carry a 25-year and manifolds a 5-year non-prorated warranty against failure due to defect in material or workmanship. Warranty shall provide for repair or replacement of any tube or fittings which are proven to be defective and pay for consequential damages.

### .3 HEAT PUMP SYSTEMS

- .1 Where justified by climatic conditions, heating and mechanical cooling requirements, energy targets, cost analysis and budget constraints, consider utilizing heat pump equipment in a form of central air-to-water **heat pump systems**, geothermal heat pump systems, **split heat pump systems**, **VRV/VRF systems** or **water source heat pump systems**. In moderate climatic conditions of the Lower Mainland and Vancouver Island, the air-to-water heat pumps (air-cooled reversible chillers) can provide efficient operation for generating chilled water for cooling and low temperature heating water for heating. For the North, Northern Interior and Southern Interior regions, a closed loop geothermal system utilizing central water-to-water or distributed water-to-air heat pumps can be considered. BC Housing shall provide signoff for the conceptual design prior to the commencement of the working drawings for any designs proposing this type of system.

#### .2 Air-to-Water Heat Pumps

- .1 Consider utilizing central air-to-water heat pumps for **larger size** projects located in the Lower Mainland or on Vancouver Island. For projects using in-suite electric baseboard heaters and a central heat recovery system for ventilation, consider utilizing an air-to-water heat pump system for heating and cooling of the common and amenity areas and for supplementary heating and mechanical cooling of ventilation air. Consider utilizing a larger air-to-water heat pump system for projects using in-floor heating.
- .2 Each central air-to-water heat pump system shall be provided with a full backup from gas-fired boilers. The boiler system shall be designed to provide supplementary heating to the heat pump loop when the heat pumps cannot cover all heating loads by themselves and to provide a sole source of heating in case of a heat pump failure or at extremely cold outdoor conditions.
- .3 Noise generated by air-to-water heat pumps located, in most cases, on the roof shall be taken into account when considering using this system. Obtain comments from the acoustical consultants and consider using acoustical screens, low-noise condenser fans and additional noise attenuation for compressors.
- .4 Air-to-water heat pumps shall be protected from freezing. For buildings, which do not have emergency power provide minimum 25% polypropylene glycol solution in the heat pump source loop. Separate the heat pump source loop from the building load loop with a heat exchanger. For buildings, which have emergency power it is up to the Engineer of Record to choose between an option of providing glycol solution or using heat tracing connected to

emergency power for freeze protection.

- .5 Provide a buffer tank in the heat pump loop to allow for minimum runtime of compressors. Size a buffer tank as per the manufacturer's recommendations. A switchover heating-to-cooling system with a single buffer tank is acceptable but the system shall be designed to provide a minimum 10 hours delay between switching from a cooling to a heating mode and vice versa. Prevent the startup in the cooling mode until temperature in the buffer tank is less than 26°C (80°F).
- .6 Consider utilizing the air-to-water heat pump system for preheating of domestic hot water.

### .3 Geothermal Heat Pumps

- .1 An option of utilizing a closed loop geothermal heat pump system shall be carefully analyzed against the extra initial cost of installation. Verify the existing database of drilling conditions in the area of the project before proposing this option. Consider utilizing a small geothermal system for heating and cooling of the common and amenity areas and for supplementary heating and mechanical cooling of ventilation air. Avoid designs with a largely unbalanced cooling loads in summer and heating loads in winter as this can result in a gradual degradation of the ground loop performance.
- .2 For projects exceeding 15 vertical geothermal wells and for all projects in areas without the confirmed database of drilling conditions, arrange for drilling a test well including a Formation Thermal Conductivity (FTC) test. The test well shall be located in an area, which would allow re-using the test well and connecting it to the final ground loop.
- .3 The design and installation of the geothermal heat pump system shall comply with CSA Standard C448 Series 02 "Design and Installation of Earth Energy Systems", CSA Standard C446 "Performance of Ground Source Heat Pumps" and International Ground Source Heat Pump Association (IGSHPA) standards.
- .4 All ground loop piping shall be high density polyethylene piping manufactured from resin compound PE3408 and extruded to CSA Standard B137.1. All polyethylene piping shall carry CSA identification.
- .5 The ground loop shall be charged with 20% polypropylene glycol antifreeze solution. For boreholes with depth up to 100 m (330 ft), use 25 mm (1") diameter polyethylene SDR-11 pipes rated at 1,107 kPa (160 psi). For boreholes exceeding depth of 100 m (330 ft), use 32 mm (1-1/4") diameter polyethylene SDR-9 pipes rated at 1,730 (250 psi). The boreholes shall be pressure grouted with thermally enhanced grout. Connect piping from individual boreholes to supply and return horizontal headers not exceeding 50mm (2") diameter in a "reverse return" configuration. Provide multiple headers and design the ground loop not to exceed the maximum pressure drop of 150 kPa (50 ft) up to and including manifolds inside the building.
- .6 Provide a bypass connection separating the ground loop from the building loop. This is to allow commissioning of the ground loop before the building installation is complete. Pressure test piping in vertical wells, each header assembly and the entire ground loop. Purge and flush the entire loop prior to addition of antifreeze.
- .7 The ground geothermal loop shall be installed by an experienced contractor with IGSHPA certification and approved by the Consultant.

- .8 Consider utilizing the water-to-water heat pumps, distributed air-to-water heat pumps or a combination of both. Consider utilizing the water-to-water heat pump system for preheating of domestic hot water.

#### **.4 Split Heat Pump Systems**

- .1 Split heat pump systems include: Single-Zone Mini-Split Heat Pump Units, Multi-Zone Mini-Split Heat Pump Units and Multi-Zone Mini-VRF Heat Pump Units. These systems can be considered for small to medium size projects.

Each of these systems can be considered for providing heating and cooling in any Climate Zone. There are a number of suppliers to choose from as these systems gain popularity due to a reasonable cost and good energy efficiency performance. The following criteria shall be considered in choosing these HVAC systems:

- All outdoor units shall be provided with DC inverter compressor.
- Ductless wall mounted fan coil units are preferred for indoor units.
- No remote wireless controllers are allowed. All thermostats shall be hard-wired, wall mounted, easy to operate thermostats.
- Selected heat pump equipment shall be capable of providing all heating requirements without a need for auxiliary electric heating. Unit installed in colder Climate Zones shall be provided with a low ambient option.
- Separate ventilation system using ERVs shall be provided.

#### **.2 Single-Zone Mini-Split Heat Pump Units:**

Each zone will be provided with a single, self-contained system. This will require a sufficient wall space outside each residential apartment for mounting of the outdoor unit and might not work well for buildings with a large number of apartments. This system can be considered for cooling and heating of “non-typical”, single zone areas, such as dining or lounge areas.

#### **.3 Multi-Zone Mini-Split Heat Pump Units:**

This system reduces a number of outdoor units. Typically, one outdoor unit can serve up to five indoor fan coils and is limited to 4-tons capacity. Each individual fan coil unit will require a “homerun” refrigerant piping connection to the outdoor unit. Individual zones served by a single outdoor unit should face the same orientation as all fan coil units can operate in either heating or cooling mode at any given time. Outdoor units should be located, preferably, on the roof of the building.

#### **.4 Multi-Zone Mini-VRF Heat Pump Units:**

This system reduces a number of outdoor units even further. Typically, one outdoor unit can serve up to nine fan coil units and is limited to 5-tons capacity. It also significantly reduces amount of refrigerant piping as “homeruns” from each fan coil to the outdoor unit are not required. Individual zones served by a single outdoor unit shall face the same orientation as all fan coil units can operate in either heating or cooling mode at any given time. Outdoor units should be located, preferably, on the roof of the building.

## **.5 Variable Refrigerant Volume (VRV) / Variable Refrigerant Flow (VRF) Systems**

- .1** VRV or VRF system uses refrigerant for transferring cooling or heating energy from the outdoor unit(s) to multiple indoor DX fan coil units.

Indoor units come in a variety of configurations: ductless wall mounted units, low-profile ducted fan coils, high capacity ducted fan coils, ceiling cassettes and floor mounted consoles. It can be used for any size building. Some manufacturers offer the low ambient option, which can be used in Northern Regions.

- .2** This system can come in a two or three-pipe configuration and as a heat pump version (all indoor units connected to the outside unit can operate in either the heating or cooling mode) or as a heat recovery version (indoor units can operate simultaneously in the heating or cooling mode).

In evaluating the VFV / VRF system for BC Housing projects, the heat pump version of this system should be considered. Ductless wall mounted indoor units are preferred, except for the larger apartments where low-profile fan coil units can be considered.

- .3** The VRV / VRF system will require a separate ventilation system. This would have to include a central or semi-central energy recovery ventilators or individual in-suite energy recovery ventilators.
- .4** VRV / VRF system requires a central proprietary control system and will require a specialized maintenance and servicing. It is a very energy efficient system but it may be cost prohibitive. It should also be avoided in the remote locations where specialized service is not available.

## **.6 Water Source Heat Pump System**

- .1** This system includes reversible water-to-air heat pump units connected to a two-pipe condenser loop for heat rejection (in the cooling mode) or heat absorption (in the heating mode). The central condenser loop is connected to the boiler plant (for adding heat to the loop) and to the outdoor closed-circuit fluid cooler (to reject heat from the loop).

Typically, residential water source heat pumps are floor mounted, vertical configuration units. Amenity / office areas can be served by horizontal ceiling mounted units.

- .2** This system allows moving energy through the condenser loop between the parts of the building requiring simultaneous heating and cooling. It also allows heat recovery, in the heating season, from heat pumps providing cooling of the electrical sub-station. The water source heat pump system has good energy efficiency and reasonable first cost. As a centralized HVAC system, it can be considered for larger size buildings in any Climate Zone.
- .3** This HVAC system will require a separate ventilation system. This would have to include a central or semi-central energy recovery ventilators or individual in-suite energy recovery ventilators.

## **.4 TWO-PIPE SWITCHOVER FAN COILS**

- .1** This system includes a boiler plant, air-cooled chiller (or optionally an air-cooled heat pump chiller) and either floor mounted vertical fan coil units or low-profile ceiling mounted fan coil units.

- .2 The two-pipe switchover hydronic distribution system is recommended over the four-pipe chilled water / hot water system (more typical for the market housing developments), to make it simpler, easier to maintain and less expensive. This will result in some temperature comfort issues during the shoulder seasons, but the lower cost and simplification of the hydronic piping distribution justify considering it for the social housing projects.
- .3 The two-pipe switchover hydronic distribution system is recommended over the four-pipe chilled water / hot water system (more typical for the market housing developments), to make it simpler, easier to maintain and less expensive. This will result in some temperature comfort issues during the shoulder seasons, but the lower cost and simplification of the hydronic piping distribution justify considering it for the social housing projects.
- .4 This HVAC system will require a separate ventilation system. This would have to include a central or semi-central energy recovery ventilators or individual in-suite energy recovery ventilators. Using the option of build-in ERVs integrated with vertical fan coil units, offered by some manufacturers, can also be considered.

## .5 PACKAGE TERMINAL AIR CONDITIONERS (PTACS)

- .1 PTACs are self-contained through-the-wall heating and air conditioning units (with optional ventilation accessory), which are a common choice for hotels and some residential buildings. They come in a variety of options, including a heat pump option with auxiliary electric heating to accommodate low ambient conditions in all Climate Zones.
- .2 PTACs are, generally, not recommended for the BC Housing projects due to a large sleeve opening through the wall, which compromises the envelope performance and due to excessive noise. The thermal bridging through the envelope combined with untreated ventilation air (mixed with return air) result, in most cases, in exceeding the energy efficiency targets.

PTACs can only be considered as an exception, evaluated on a project-by-project basis and approved by BC Housing. With no exceptions, this system, if considered, shall meet the BC Housing Energy Step Code requirements.

- .3 In evaluating the PTAC option, consideration should be given to choosing the premium units available on the market, which offer features addressing the energy performance requirements and sounds levels. Units with better Energy Efficiency Rating (EER), better Sound Transmission Loss (STC) rating and better Outdoor Indoor Transmission Class (OITC) rating should be considered in evaluating the PTAC option.
- .4 The PTAC unit shall be a heat pump unit with an auxiliary electric heater for cold ambient conditions.

The ventilation option through the PTAC unit can only be considered if the unit can operate continuously with an acceptable noise level and if supplying untreated outdoor air through the unit meets the energy efficiency criteria. Otherwise, a separate ventilation system using ERVs should be provided.

## .6 VENTILATION

- .1 The design of ventilation systems shall comply with the requirements of ASHRAE Standard 62-2001, Section 9.32 of the BC Building Code and Vancouver Building By-law and BC Housing standard for residential suites where tobacco smoking is permitted, as listed in [Section 4](#)

Construction Standards - Division 23, Sub-Section 1.4 - Ventilation.

- .2 All major ventilation systems shall include heat recovery with a minimum sensible heat recovery effectiveness (or Apparent Sensible Effectiveness for in-suite ERVs) of 75%. Option of air bypass or other means of stopping heat transfer should be considered for all heat recovery systems to utilize shoulder season or summer night time cooling. Wherever practically possible, buildings should be provided with central or semi-central ERV systems.
- .3 Ventilation rates for central and semi-central ERVs shall be minimum 23L/S (49cfm) for studio and one-bedroom apartments, 30l/s (64cfm) for two and three-bedroom apartments with a single bathroom and 47l/s (100cfm) for three-bedroom apartments with two bathrooms.
- .4 The central heat recovery ventilation air handling units shall include supply and exhaust fans, enthalpy heat recovery energy wheel with variable speed controls, heating coil or a combination heating/cooling coil, filters and motorized dampers on outdoor air and exhaust intakes.

Utilizing a combination of heating/cooling coil and providing mechanical cooling of ventilation air is a preferred option as it provides means of partial mechanical cooling for residential apartments. Increasing minimum ventilation rates for the apartments facing south and west can be considered as means of providing better partial cooling during the summer season. Where practical, oversizing the capacity of ERVs and distribution ductwork can be considered as additional means of increasing partial cooling capacity. In this case, ERVs would operate at a lower speed during the heating season and would automatically increase speed to provide more cooling during the cooling season.

Exhaust air shall be ducted to the central heat recovery ventilation air handling unit from all bathrooms in residential suites. Supply air shall be distributed to all bedrooms and living areas. Supply and exhaust ducts should be, preferably, distributed in the corridor ceiling plenums. Limit size of the distribution ducts to maximum 150 mm (6") in height. For larger buildings, consider utilizing multiple air handling units to limit size of distribution ducts. Supply and exhaust connections to residential suites should be, typically, 125 mm (5") diameter flexible duct connections to help conserving headroom in corridors and to provide access to fire dampers required at wall penetrations. Non-insulated flexible duct connectors shall be made from heavy vinyl-coated fiberglass cloth mechanically locked together with a scuff protecting galvanized steel helix, Flexmaster Fabriflex type 4, or approved equal. Insulated flexible duct connectors shall be insulated reinforced aluminized trilaminate flexible ducts mechanically locked together by a galvanized steel helix with a flame retardant polyethylene vapour barrier, Flexmaster Fabriflex type 5T, or approved equal. It is mandatory to connect flexible to rigid ducts using stainless steel worm gear type clamps.

If the central ventilation system serves common and amenity areas in addition to residential suites, consider providing a separate heat recovery ventilation unit for the amenity areas to allow shutting it down during the unoccupied hours.

- .5 For smaller buildings, utilizing a standard gas-fired or heat pump rooftop unit integrated with a separate heat recovery ERV can be considered as a cost-effective solution for providing a central ventilation system with heat recovery and supplementary cooling / heating options.

- .6 Individual in-suite energy recovery ventilators (ERVs) shall be installed with proper access for maintenance and servicing. ERVs shall be provided with Electronically Commutated Motors (ECMs) on supply and exhaust fans. In-suite ERVs for apartments with single bathrooms shall be sized for minimum 17L/s (35cfm) air flow at the continuous low speed and 33 L/s (70 cfm) at the high speed when activated by a switch in a bathroom.

Ventilation units for apartments with two bathrooms shall be sized for minimum 24L/S (50cfm) at the low speed and 47L/S (100cfm) at the high speed. Round 150 mm (5") diameter concentric adjustable grilles, either ceiling or wall mounted, are recommended for exhaust and supply air distribution.

An ERV in a residential suite shall be ducted to all bathrooms on the exhaust side and to all bedrooms and a living area on the supply side.

In buildings with concrete construction located in the Lower Mainland or on Vancouver Island utilize in-slab ducts for outdoor air intake and exhaust discharge. Intake ducts shall be wrapped with a reflective type insulation for a minimum of 6 m (20 ft) from outside wall. Where possible, maintain a minimum 1.8 m (6 ft) separation between exhaust outlets and outdoor air intakes. ERVs shall operate continuously at a low speed and shall automatically turn into a high speed by turning on a switch in any bathroom.

Consider providing a single ERV serving more than one residential suite and located in the common area.

- .7 Utilizing corridor pressurization as means for providing ventilation for residential suites is not permitted. Corridors shall be ventilated as per the requirements of ASHRAE Standard 62-2001. Transfer of tobacco smoking and cooking odors between suites and to a corridor shall be controlled by proper airtightness of partition walls.
- .8 Provide residential kitchens with range hoods as per [Division 11 30 00 - Equipment](#). A charcoal filtered (ductless) range hood can be considered only for Passive House projects with approval from the Owner and AHJ.
- .9 Fresh air intakes must be galvanized steel or aluminum watertight hood type or weatherproof louver type with insect protection. Wall type grilles are not acceptable. All exhaust hoods must have a backdraft damper. Intakes must be designed to prevent rain penetration at design wind pressure for the location. Connections must be sealed to the weather barrier of the wall assembly. Each hood or louvre must be connected to the duct it serves by durable airtight connections. Screens must be removable for cleaning.

## .7 TENANT LAUNDRY ROOMS

- .1 Except where using condensing or heat pump dryers, include provisions for adequate make up air. Make up air shall match air exhausted by dryers. Consider means of heating make up air when using outdoor air. Transfer of air from surrounding areas may be used. Consider utilizing a concentric venting system (inner exhaust and outer make up air intake) as means of pre-heating make up air.
- .2 Connect exhaust dryers directly to building exterior (outside). Do not use plastic or thin foil ducting, use rigid metal duct. Condensing or heat pump dryers require only a connection to a drain pipe.
- .3 Provide dryer exhaust duct(s) to 102 mm (4") from floor level for subsequent connection to appliances.

### **.8 PARKING EXHAUST**

Provide mechanical exhaust ventilation for common underground or enclosed parking areas, controlled by CO and combustible gas sensors. Install CO sensors 1.5 m and combustible gas sensors 150 mm above the floor level. Locate parking exhaust louvers a minimum of 3 m (10 ft) clear of any operable window or fresh air intake

### **.9 TEMPORARY USE OF SYSTEMS**

- .1** The Contractor shall obtain the Owners' permission prior to using any permanent heating or ventilation systems during construction.
- .2** Prior to approval, the Contractor shall confirm in writing that use of heating equipment during construction does not void warranty. If approved, the Contractor must ensure that all filters are in place prior to use of the equipment.
- .3** The Contractor must also overhaul any mechanical equipment used for temporary heating or ventilation, prior to completion of project as follows:
  - .1** Replace all filters.
  - .2** Clean all pipes and ducts.
  - .3** Inspect, service and lubricate all equipment.

### **.10 LABELING**

- .1** In projects with a central distribution system, identify main valves, pipes and devices. In individual units identify each hot water heating zone indicating room, area of service and length of each loop if system is radiant in-floor heating.
- .2** Band main piping with 51 mm (2") wide pressure sensitive self-adhering plastic coated tape, colour-coded. Provide colour code and arrows and words to identify pipe or duct function and flow direction.
- .3** Provide colour-coded piping in boiler and equipment rooms complete with flow indication. Provide to each valve in these rooms a brass tag, embossed with valve number. Install charts listing these valves and their purposes, together with remarks concerning operation, in glassed-in frames fixed to the walls of rooms.
- .4** Provide a directory of these valves.

## **3 Execution**

- .1** Connect natural gas supply lines to equipment with proper approved flexible connectors.
- .2** Construction assembly penetrations:
  - .1** Fit wall finishes and cabinet backs with escutcheon around openings for supply and waste piping where pipes are hidden in cabinetry.
  - .2** Caulk gaps between wall finishes and pipes where the gap is less than 13 mm (1/2"). For gaps

greater than 13 mm (1/2"), provide escutcheon plate.

- .3 Where escutcheon plates are too small to cover the gap, neatly patch with the prefinished material used for cabinet backs or with the same wall finish as the pipe surround.
- .4 All openings through fire separations shall be repaired to maintain the integrity of the fire separation. Any openings around piping or ductwork shall be sealed with a ULC listed fire-stop and smoke seal system. Refer to [Division 07 80 00 - Firestopping and Smoke Seals](#).
- .5 Provide vibration and acoustic isolation treatment for mechanical equipment, to prevent vibration and noise transference to adjacent living spaces.

### .3 PIPING

- .1 Insulate heating and cooling piping with preformed glass fibre type insulation. Insulate all supply and return piping as required by ASHRAE 90.1 - 2010 and follow BC Insulation Contractors Associations approved insulation details.
- .2 Provide supports for pipes. Maintain required grading by adjustment; allow for expansion and contraction and produce a neat appearance. Design supports to suit loading and services. Prevent undue stress to structural members. Supports must secure pipe and prevent vibration.
- .3 For all copper horizontal piping use wrought clevis hangers 25 mm (1") larger than pipe diameter suitable for vertical adjustment, isolated from pipe with plastic tape.
- .4 Provide access panels to concealed valves and clean-outs. ULC rating required in rated assemblies.
- .5 Install escutcheon plates at piping penetrating wall.

### .4 DUCTS

- .1 All duct joints must be sealed with a water-based duct sealant to ensure no air leakage into surrounding space. Where required, ducts must be insulated with glass fibre wrap to ASHRAE 90.1 - 2010 and to prevent condensation within the duct.
- .2 Ducts which penetrate the weather barrier of the exterior wall assembly must be sealed to the weather barrier using self-adhesive bituminous membrane, expanding foam sealant, and/or an accessory specifically designed to provide a water and air tight connection to the weather barrier of the exterior wall assembly.

### .5 SEISMIC RESTRAINT

- .1 Seismic restraint must be provided for all mechanical equipment and accessories including attachment to structural members where required by code.
- .2 Letter of Assurance from Seismic Professional Engineer Registered in BC on commencement of design and completion of field review must be provided to confirm that seismic restraint meets regulatory requirements.

End of Section

# 26 00 00 - Electrical

## 1 General

- .1 Sustainable and energy efficient strategies are fundamental design strategies to be implemented in the project. Refer to [Energy and Environmental Design](#) section.
- .2 Each project shall be designed in accordance with the specific requirements of available incentive programs such as BC Hydro's Power Smart Program. The Consultant shall complete and submit BC Hydro Lighting Calculator to BC Housing at the Construction Document review phase. Reference the BC Hydro Lighting Calculator for additional design guidelines. Refer to [Energy and Environmental Design](#) section.
- .3 Measures shall be implemented to reduce energy consumption. Control systems shall be installed to reduce energy consumption and shall include measures beyond the mandated requirements such as the valid edition of ASHRAE 90.1. Whenever practical utilize lighting controls like occupancy sensors, vacancy sensors, day lighting sensors etc.
- .4 Provisions shall be included to reduce peak electricity demand by at least 10%, not including use of stand-by power generator (where provided). Refer to ASHRAE 189.1 for further information.
- .5 All material and/or equipment installed must be "Approved", as and bear evidence of approval as defined in Canadian Electrical Code adopted for use in BC by Technical Safety BC. All material and parts shall be readily available locally.
- .6 All equipment must remain clean during construction and be thoroughly cleaned to "as new" condition prior to Substantial Performance.
- .7 **Electrical System Commissioning:**
  - .1 The commissioning of the electrical systems is the responsibility of the electrical contractor.
  - .2 The electrical consultant is responsible to ensure that all commissioning items, related tests (outlined in Section 4, Division 01 91 00 - Building Commissioning) are incorporated in the contract documents at a minimum and final testing are completed at the end. The electrical consultant is to review and update the list of the tests as necessary based on complexity of the building and to meet the local codes and authority having jurisdiction.
  - .3 Test all portions of electrical systems including electrical coordination of all other building systems. The contractor shall carry out the tests in presence of Consultant and any 3rd party if required by the contract document. Log and tabulate test results, date and sign, and incorporate in Operating and Maintenance Manuals. Testing, commissioning, and/or verification are included in the contract.
  - .4 For projects where there is no rezoning or funding partner's commissioning requirement, if the building is 7 storeys or higher or it is deemed as having increased complexity, the Owner or BC

Housing may retain an independent commissioning provider to commissioning the electrical systems as related to life safety that are not part of ULC S537 "Verification of fire alarm systems" (such as smoke control and smoke venting equipment including fan and dampers, hold-open device/electro-magnetic locks, fire-pumps, generator, etc.). The consultant will consult with Owner or BC Housing at early development phase for the commissioning option requirements.

- .5** The general contractor is responsible for coordinating integrated systems testing to meet the requirements of CAN/ULC S1001 Integrated Systems Testing of Fire Protection and Life Safety Systems at the completion. The consultant will include this in the specification for all types of projects.
- .8** Contractor shall review the Electrical drawings in coordination with all other drawings and specifications provided for the project. Verify the existing site and electrical systems and report any discrepancies to the Engineer. It is the responsibility of the Contractor prior to submitting a bid to field measure exacting raceway routes.
- .9** Contractor shall review the Electrical drawings in coordination with all other drawings and specifications provided for the project. Verify the existing site and electrical systems and report any discrepancies to the Engineer. It is the responsibility of the Contractor prior to submitting a bid to field measure exacting raceway routes.
- .10** Execute all work in a professional manner, to present a neat mechanical appearance, co-ordinate and arrange equipment in proper relation with other apparatus, ducts, pipes, etc. and with building construction and finishes. Before execution of work, coordinate the installation with all other consultants, contractors and subcontractors for consistency and completeness. No consideration will be given for extra cost due to lack of coordination between trades.
- .11** If core drilling of existing structure (floors and slabs) is required, contractor shall provide for x-ray or feroscan to ensure no damage is done to existing structure and infrastructure (rebar, conduits, cables etc.). Before core drilling obtain permission from structural engineer and coordinate schedule with BC Housing.
- .12** Refer to [General Design Guidelines](#) section for details regarding project closeout deliverables such as as-built drawings, spare parts and maintenance manuals.
- .13** For elevator requirements refer to [Division 14 20 00 - Elevators](#). Ensure provisions for all related infrastructure is included in the electrical/telecommunication systems.
- .14** Penetrations through any exterior envelopes and assemblies (fire rated separation, smoke control separations, air control and others) shall be conducted in such a manner that integrity of assemblies is maintained.

- .15** All electrical wires, cables, non-combustible raceways, outlet boxes and other similar services that penetrate fire separation or assembly required to have a fire resistance rating or fire separation, shall be sealed by a fire stop system which has an "F" and/or "FT" rating not less than the required fire protection rating of the fire separation. "F" and "FT" ratings will be determined by fire test method ULC S115 "Fire Tests of Fire Stop Systems". Refer to B.C. Building Code, Article 3.1.9.1(1) and (2), Fire Stopping of Service Penetration. Contractor shall use materials and methods as listed in "ULC List of Equipment and Materials Volume 2, Building Construction" (No. 40U18 Fire Separation and NO.40U19 Fire Stop System Components). ULC List of Equipment and Materials, Fire Stop Systems and Components Engage supporting professional to design and review fire stopping. Coordinate installation with other trades.
- .16** Provide a copy of the final electrical inspection certificate to the Electrical Engineer or Owner upon project completion before requesting a final review.
- .17** Contractor shall supply and install electric baseboard heaters including controls, **baseboard heaters shall be heavy duty commercial construction with a 20-gauge cold rolled steel front cover and brackets to limit vandalism**. Obtain from mechanical consultant specification sizes and location of baseboard heaters.
- .18** Provide full 2 years warranty on all labour and materials for projects under Part 3 buildings for new construction. For Part 9 projects and renovation projects, provide one year warranty. Contractor shall repair or replace any item which proves to be defective due to workmanship, equipment, or materials, without any cost to the Owner.

## 2 Products & Installation

### .1 UTILITY SERVICES

- .1** Provide termination for incoming Hydro, Telephone and CATV ducts and cables. Obtain service connection point and locations of all ducts with Supply Authorities before installation. Provide nylon pull cord for Hydro, Telephone, and CATV ducts. Include all Hydro utility, Telephone utility and CATV charges. Include secondary conductors where required by the local Hydro utility. Coordinate all service related activities with relevant utilities.
- .2** All service connections to utility networks must be underground unless directed otherwise by BC Housing and/or other relevant authorities.

### .2 MAIN DISTRIBUTION AND METERING

- .1** Main service voltage must not exceed 250 V unless specific approval is received from the Owner and BC Housing. This condition is imposed to limit maintenance costs associated with services of higher voltage.
- .2** Surge Protective Devices (SPD), as a minimum, must be provided on the service entrance main distribution (Category C).

In accordance with sound engineering practice additional protection if required shall be provided in category B and category A locations. SPD Installation shall conform to ANSI/UL

1449 current edition Standard for Safety for Surge Protection Devices.

- .3 If required by codes, provide power and any monitoring of heat tracing.
- .4 Continuous separate demand and consumption metering equipment shall be considered for lighting loads, mechanical loads, process equipment loads and power loads where it is determined that monitoring of energy demand and consumption values are beneficial. Minimum provisions shall include distribution design to facilitate installation of separate meters for each load type in compliance with ASHRAE. As a minimum requirement of the design, the Consultant shall define a methodology describing the implementation of demand and consumption metering equipment in the future.
- .5 Demand side management provisions shall be incorporated in the design and installation of the main distribution equipment shall be in accordance with ASHRAE 189.1.
- .6 A complete system of grounding must be provided in accordance with code requirements. In addition to code/safety requirements, adequate grounding must be provided for all technology systems as required by relevant standards.

### .3 BRANCH CIRCUIT PANELBOARDS

- .1 All common area Panelboards must be bolt on (or equal) molded case circuit breaker type, with copper mains, rated for the available interrupting capacity. All electrical equipment including panelboards shall include sprinkler hoods/shields in sprinkled areas.
- .2 Residential suite panels must be provided with main disconnecting means (main breaker) and must incorporate a means to lock out range branch circuit.
- .3 All two and three pole breakers must have common trip type with single handle.
- .4 A minimum of 20% spare capacity must be provided for all common area panelboards.
- .5 Locate suite electrical panel board in an accessible location.
- .6 Arrange circuiting to balance loads for all phases.
- .7 All Panelboards shall be equipped with panelboard directories clearly identifying all circuits.
- .8 Mounting heights for all devices must be in accordance with the table below:

**Table: Electrical Device Mounting Heights**

DEVICE DESCRIPTION	HEIGHT ABOVE FLOOR
Light switches, card readers – to center	1067 mm (3'-6")
Duplex receptacles, Communications outlets (Tel, Data, CATV, A/V) – to center	455 mm (1'-6")
Thermostats and control devices – to center; align vertically with light switch	1067 mm (3'-6"), depending on the housing and tenants, mounting height may differ
Exterior Receptacles/ Washer/Drier Receptacles	915mm (3')
Entry Phone Panel	Controls to be within a range to meet accessibility requirements and in consultation with the AHJ

#### **.4 WIRING METHODS**

- .1** The maximum ampacity of wire and cable must be based on the ratings as defined by 75° column of the applicable CSA 22.1 Canadian Electrical Code, Table 1 through 4 and Section 12.
- .2** All wiring must be fire rated and or have proper fire protection and separation to meet BCBC.
- .3** All wiring must be copper, except for main distribution feeders 100 Amps or larger and residential suite panel feeders sized 60 Amps or larger where aluminum conductors of the same ampacity may be utilized. Aluminum wiring alloys shall be AA8030 (or NUAL) also known as Aluminum Conductor Material (ACM). Aluminum conductor terminations shall be completed using appropriately approved plating, hardware and processes. All conductors/feeders sizing shall include derating due to distance and limitation to voltage drop The installation shall conform to the following specification:
  - .4** Aluminum Alloy Conductors – Distribution Feeder Applications with Recommendations for Connections:
    - .1** Distribution Feeder Installation
      - .1** Distribution feeder conductors in sizes #6 AWG to 1000 kcmil may be copper or aluminum conductor material (ACM).
        - .1** Aluminum alloy conductors shall be compact stranded conductors of NUAL® (AA-8030) as manufactured by Alcan Cable or of a recognized 8000 Series aluminum alloy conductor material by the Aluminum Association.
        - .2** Manufacturer shall verify compliance with the elongation requirement per Table 10.1 of UL Standard 1581 for stranded AA-8000 series aluminum alloy conductors on wires taken from the conductor after stranding.
      - .2** Insulation:
        - .1** For use in raceways: Sizes #6 AWG to 1000 kcmil Type RW90, temperature rating 90° C.
      - .3** Connections for Conductors:
        - .1** Using Mechanical Screw Type Connectors:
          - .1** Connectors shall be dual rated (AL7CU or AL9CU) and Listed by CSA for use with aluminum and copper conductors and sized to accept aluminum conductors of the ampacity specified.
          - .2** Using a suitable stripping tool, to avoid damage to the conductor, remove insulation from the required length of the conductor.
          - .3** Clean the conductor surface using a wire brush and apply a CSA listed joint compound.
          - .4** Tighten the connection per the connector manufacturer's recommendation.
          - .5** Wipe off any excess joint compound.
        - .2** Using Mechanical Compression Type Connectors:
          - .1** Connectors shall be dual rated (AL7CU or AL9CU) and Listed by CSA for use with aluminum and copper conductors and sized to accept aluminum conductors of the

- ampacity specified.
- .2 The lugs shall be marked with wire size, die index, number and location of crimps and shall be suitably colour coded. Lug barrel shall be factory pre-filled with a joint compound Listed by CSA.
  - .3 Using a suitable stripping tool, to avoid damage to the conductor, remove insulation from the required length of the conductor.
  - .4 Clean conductor surface using a wire brush.
  - .5 Crimp the connection per the connector manufacturer's recommendation.
  - .6 Wipe off any excess joint compound.
- .3 Termination of Aluminum Conductor to Aluminum Bus:
- .1 Prepare a mechanical connection conforming to .1 or .3.
  - .2 Hardware:
    - .1 Bolts: Anodized aluminum alloy 2024-T4 and conforming to ANSI B18.2.1 and to ASTM B211 or B221 chemical and mechanical property limits.
    - .2 Nuts: Aluminum alloys 6061-T6 or 6262-T9 and conforming to ANSI B18.2.2.
    - .3 Washers: Flat aluminum alloy 2024-T4, Type A plain, standard wide series conforming to ANSI B27.2.
    - .4 Lubricate and tighten the hardware as per the manufacturer's recommendations.
  - .4 Termination of Aluminum Conductor to Copper Bus:
    - .1 Prepare a mechanical connection conforming to 1 or 2.
    - .2 Hardware:
      - .1 Bolts: Plated or galvanized medium carbon steel; heat treated, quenched and tempered equal to ASTM A-325 or SAE grade 5.
      - .2 Nuts: Heavy semi-finished hexagon, conforming to ANSI B18.2.2, threads to be unified coarse series (UNC), class 2B.
      - .3 Washers: Should be of steel; Type A plain standard wide series conforming to ANSI B27.2. Belleville conical spring washers: shall be of hardened steel, cadmium plated or silicone bronze.
      - .4 Lubricate and tighten the hardware as per the manufacturer's recommendations.
  - .5 Termination of Aluminum Conductor to Equipment Not Equipped for Termination of Aluminum Conductor:
    - .1 Prepare compression connection using an adapter listed by CSA for the purpose or by pig tailing a short length of suitable size of copper conductor to the aluminum conductor with a compression connector Listed by CSA.
    - .2 Provide an insulating cover over adapter body or the compression connector.

- .3 Terminate the adapter or the pigtail on to the equipment per manufacturer's recommendation.
- .5 NMD 90 cable in stud partitions may be used where permitted by code.
- .6 Minimum conductor size must be #12 AWG except for 15 Amp branch circuits within residential suites, where #14 AWG may be used. The use of code accepted 20A branch circuit wiring for receptacles is not intended to be excluded, #12 AWG shall be used for 20A branch circuit wiring in residential suites..
- .7 Distribution and Panelboard feeders must use either multiple conductor in conduits or multi conductor cables.
- .8 Conduits must be EMT type except where susceptible to mechanical damage, where rigid threaded galvanized steel conduit must be used. In some cases, armored cable (Teck90) may be permitted (consult with BC Housing before installation).
- .9 Underground conduits for branch circuit wiring and conduits in slab must be heavy wall Rigid PVC.
- .10 Use of ENT, commonly referred to as coreline, shall be reviewed on a project basis and approval shall be received from Owner and BC Housing prior to use. Under no circumstance shall ENT be utilized for telecommunication pathways.
- .11 Where accepted, ENT conduit runs shall be installed neatly parallel or at right angles to building lines, must be supported using appropriate methods (tie wire is not appropriate), must be oversized and at no time shall conduit less than 3/4" be used.
- .12 All conduits must be installed concealed in slabs, ceiling space or partitions except where permission is specifically obtained for running on the surface. Where exposed conduits must be painted to match surroundings.

## **.5 WIRING DEVICES**

- .1 Outlet boxes must be sized to suit the number of conductors. Boxes in concrete must be PVC. Plates must be "nylon" either white or as approved by Electrical Consultant, Owner and BC Housing, Plates in service areas and where susceptible to damage must be unbreakable or stainless steel.
- .2 Line voltage switches in service areas must be specification grade, rated for 120 Volt, 20 Amp operation with quiet, quick make/break toggle movement and totally enclosed case.
- .3 Receptacles in non-residential areas must be specification grade, duplex, polarized type complete with parallel and U-grounding slots and rated at 1-5/20 Ampere, T-slot 125 Volt. Mounting height must be 455 mm (1'-6") above finished floor to center of box.
- .4 All Receptacles in residential units shall be tamper-resistant type.
- .5 All wiring devices in residential areas may be residential grade white finish, "Décora" style or as approved by Owner & BC Housing.
- .6 Receptacles, telecommunications and television outlets on common or party walls shall be installed such that the continuity of the fire separation is maintained. All communication outlets must be provided with back boxes.

- .7 Weatherproof receptacles for block heaters must be provided in Zone 2 and Zone 3, cold climate areas, such as the Interior and the North. If the receptacles are to be located adjacent to the unit, they should be connected to the tenant electrical panel. If the receptacles are to be located in a common area parking lot, they should all be connected to a common area electrical panel. The block heater receptacles, in both of the above applications, must be equipped with thermostatically controlled timers capable of energizing the receptacles at pre-programmed set point temperatures and should also have the capability of cycling on and off during the times that the receptacles are energized.
- .8 Weatherproof ground fault current interrupter GFCI duplex receptacles for exterior building maintenance must be provided. These receptacles to be located to minimize potential damage and misuse and shall be switched from inside the building.
- .9 Weatherproof GFCI duplex receptacles must be provided at each unit patio and at all common area patios.
- .10 Provide GFCI electrical outlet at each bathroom vanity and on kitchen countertop in all residential suites, in a location accessible from a seated position.
- .11 Accessible units – Provide convenient kitchen outlets, light, fan and range hood controls at locations accessible from work or seated positions. Refer to CSA B651.

## .6 LIGHTING

- .1 Adequate illumination must be provided in all areas to levels as recommended by IESNA. Lighting power densities must conform to the requirements of current editions of ASHRAE 90.1, NRCC 54435 “National Energy Code of Canada for Buildings” and other applicable Federal, Provincial & Municipal regulations.
- .2 Provide lighting control zones in accordance with current BCBC, current edition of ASHRAE 90.1 requirements for perimeter and non-perimeter spaces.
- .3 Only LED type light sources shall be used for all areas. In some circumstances and depending on the feasibility, including financial constraints, other light sources may be considered. Consult with the BC Housing representatives before final selection of lighting specification.
- .4 Lighting specification must include consideration for standardization of lamps, ballasts and other luminaire components to reduce maintenance requirements, standardize components, and ease maintenance programs. Lamp types shall be minimized for maintenance ease.
- .5 Contractor shall include all lighting fixtures in a base bid. If specification for light fixture is not known at the time of tender contractor shall include the cash allowance for the supply and installation. Obtain the amount for cash allowance from BC Housing.
- .6 Refer to [Division 13 20 00 Heat Treatment Room](#) for specific requirements/layout of heat treatment room (Bed Bug Room).
  - .1 Controls, light switches, breaker boxes, electrical panel, relay box or any other heat sensitive electrical components to be located in the vestibule or outside the heat treatment room. Electrical outlets as required by the manufacturer’s recommendation for heater source. Electrical heater shall bear CSA certification and has sufficient heat output for this use.
  - .2 In Heat Treatment Rooms (bed bug rooms), light fixture must be vandal and high

temperature resistant type and c/w metal wire guard. Typically the heat is set at 60°C. All wiring and other electrical components installed in this space (including room walls and ceiling and floors) shall be rated at least 125°C. Light fixture and other electrical components have to be approved for the above conditions.

- .7 Energy efficient technology must be integrated into the chosen luminaire. Low wattage luminaires and/or fixtures are to be considered and incorporated where feasible. If applicable, ballasts must be high power factor, rapid start, sound rating "A", energy saving electronic type where appropriate.
- .8 Design shall incorporate maintenance strategies to reduce overall operating costs including specification of products that offer longer than traditional one (1) year warranties on products such as lamps, ballasts, drivers etc.
- .9 Exterior area lighting shall conform or improve upon the Illuminating Engineering Society of North America (IESNA) current edition of RP-33 standard and shall comply with current edition of ASHRAE 90.1, and requirements limiting light trespass onto adjacent properties and into adjoining rooms and spaces. Parking and general area lighting should be c/w full cut off optics.
- .10 Primary Pathways and Building Exterior shall be controlled by photocell sensor(s).  
Secondary Pathways shall be additionally controlled by local exterior motion sensors.  
Secondary pathway lighting must be provided with instant on capability.
- .11 Exterior lighting should not interfere with CCTV cameras and should not be directed at the camera itself. The lighting should illuminate the areas and provide a sufficient colour spectrum range where the cameras are intended to capture images.  
  
If cameras are directed to areas that should not be illuminated in the evening (e.g. areas immediately adjacent to bedroom windows), then illumination should be provided by methods detectable to the cameras but not the human eye.
- .12 Crawl spaces and accessible attic spaces must be illuminated utilizing luminaires with mechanical protection of lamps. Lighting design must incorporate means to adequately locate and service equipment, ducting, etc.
- .13 All luminaires shall be selected to minimize glare.
- .14 Light fixtures in bedrooms and suite corridors must contain two or more lamps.
- .15 In-suite under-counter lighting shall be vandal proof.
- .16 Luminaires, lamps, and ballast shall be selected, specified and installed to provide optimum energy efficiency, controllability and maintenance ease. Lamp and ballast combinations must be identified and must comply with current BC Hydro Power Smart programs and be eligible for the available product rebate incentive program(s). BC Hydro Lighting Calculator shall be completed and submitted to BC Housing for review at Design Development and Construction Document phase.

Luminaire specification shall include provisions for the supply of spare lamps and ballasts for initial maintenance purposes. Furnish additional materials described below that match products installed, are packaged with protective covering for storage, and are identified with labels describing contents.

- .1 Lamps: 5 lamps for every 100 of each type and rating installed. Furnish at least 2 of each

type and not more than 25 per type.

- .2 Plastic Diffusers and Lenses: 1 for every 100 of each type and rating installed. Furnish at least 1 of each type and not more than 5 per type.
- .3 Ballasts: 1 for every 100 of each type and rating installed. Furnish at least 2 of each type not more than 5 per type.
- .4 LED Drivers: 1 for every 100 of each type and rating installed. Furnish at least 2 of each type not more than 5 per type.
- .5 Globes and Guards: 1 for every 20 of each type and rating installed. Furnish at least 2 of each type and note more than 3 per type
- .6 For integrated LED type fixtures without replaceable bulbs, provide 5 easily replaceable part/fixture for every 50 light fixtures.
- .17 Lighting products are to be readily available from well-established manufacturer's and Energy Star labeled (refer to NRCAN), and/or listed in the BC Hydro e-catalogue.
- .18 In order to assist in selecting and implementing energy efficiency products, BC Housing strongly recommends that electrical contractors and/or installers are approved BC Hydro Power Smart Alliance members. This is to ensure that BC Housing is eligible for any BC Hydro incentive programs.

## **.7 EMERGENCY LIGHTING AND EXIT SIGNS**

- .1 Where provided, emergency generator shall be utilized for supply of power to emergency lighting. All luminaires used for emergency lighting must immediately illuminate on actuation of emergency power source.
- .2 Contractor shall, at substantial performance stage, conduct testing/commissioning of all emergency and exit signs. Submit to the engineer Commissioning report with statement that EM Lighting and Exit signs are installed and are operating as per construction drawings and CEC.
- .3 Consideration will be given for emergency lighting integrating battery backup into lighting fixtures. The maintenance and consistency of the application must be reviewed. The intent is to minimize the types of devices within the building.
- .4 Emergency battery packs and remote heads shall be utilized where generator is not provided. Each pack must be sealed with a minimum 5 year manufacturer's warranty, wall mounted with approved bracket supports. Remote heads must be 12 Volt LED type.
- .5 The total load (lighting heads connected) connected to the battery must operate for time required by the BC Building Code with a minimum of 87.5% of rated battery voltage output. Note the required emergency lighting levels exceed BC Building Code minimum requirements.
- .6 EXIT signs
  - .1 Located to clearly indicate the direction of travel and be clearly visible. If required, low mounted (480mm AFF) Exit signage in addition to BCBC requirements on exit routes is recommended to assist all users along exit routes – particularly people who have vision impairments.

- .2 Posted at all exits and the building entrance regardless of building height.
- .3 Lamping and Powered:
  - .1 All EXIT signs must be green pictogram LED type and connected to both normal power source and approved emergency power source. Separate raceways must be provided for each source, or
  - .2 Use of self-powered EXIT signs is acceptable only where applicable and approved by the Owner and BC Housing.

## **.8 EMERGENCY GENERATORS**

- .1 Emergency or back-up generators shall be provided for the following type of projects, even where not required by Code or the Authority Having Jurisdiction. Refer to [Section 1.9.3.4.10](#).
  - .1 Those specifically designated by BC Housing as an Alternate Work Site, Emergency Operations Centre, Reception Centre or Group Lodging Facility
  - .2 Housing for seniors or persons with disabilities where prolonged power outages could present a safety or major mobility issue
  - .3 Projects where local conditions or remoteness of location could affect the operation of the project or needs of the residents during prolonged power outages
- .2 Systems or items commonly supported by the back-up generator include:
  - Fire alarm equipment
  - Emergency and exit lighting
  - Emergency voice communication systems
  - One elevator
  - Digital access control systems
  - Water pumps in buildings heated by gas fired hot water systems
  - Two duplex receptacles in an office &/or common room (for a fridge and charging systems)
- .3 For sites designated to become an Alternate Work Site, Emergency Operations Centre, Reception Centre or Group Lodging Facility, additional capacity should be provided for:
  - Intercom system
  - CCTV system
  - 70-100% of lighting within the building
  - Multiple duplex receptacles for equipment
  - Network equipment (per IT requirements)
  - Minimum operational periods (fuel loads) are recommended to run for 72 hours for the above specialty support sites.
- .4 Emergency or back-up generators shall use diesel fuel.
- .5 Location of the generator shall be discussed with the Owner/Operator at the early design stage.
- .6 The design requirements for the generator shall be based on local conditions to establish the

most cost-effective method of delivering the service while meeting the needs of the residents and the project.

## **.9 FIRE PROTECTION – FIRE ALARM SYSTEM**

- .1** Provide a complete and operational Fire Alarm system as required by the BC Building Code, Authority Having Jurisdiction and as described herein.
- .2** Provide an addressable type Fire Alarm System. In some cases an analogue system could be considered. Consult with BC Housing representatives before final specification is chosen. Use Fire Alarm Systems Manufacturers as shown in Fire Alarm Specifications. Obtain approval from BC Housing if other systems are proposed.
- .3** All fire alarm interlocks with other equipment (re-circulating air equipment, magnetic door holders, etc.) must be provided.
- .4** A primary annunciator panel (LED display) will be located in close proximity to the main entrance to the building for ease of emergency personnel response. This location must be approved by the local Fire Department.
- .5** Electrical Supervision – The fire alarm system will be electrically supervised. The sprinkler system will be electrically supervised to indicate a supervisory signal on the annunciator for each of the following:
  - .1** Movement of a valve handle that controls the supply of water to sprinklers,
  - .2** Loss of excess water pressure required to prevent false alarm in a wet pipe sprinkler system,
  - .3** Loss of air pressure in a dry pipe sprinkler system,
  - .4** Loss of power to any automatically starting fire pump,
  - .5** A temperature approaching the freezing point in any dry pipe sprinkler system valve enclosure,
  - .6** Loss of power to heat trace installed on sprinkler piping, and
  - .7** Movement of a valve handle that controls the supply of water to the standpipe system (except for standpipe system hose valves).
- .6** Signals to Fire Department – The fire alarm system shall be designed to automatically transmit separate independent signals for fire alarm, supervisory, sprinkler flow, and trouble signals to the Fire Department via an independent central station (ULC listed central station).
- .7** Annunciators and Zoning
  - .1** An annunciator shall be provided at the fire department response point.
  - .2** Within each storey, separate zones are required for each device type (sprinkler flow switch, smoke detectors, and manual pull stations).
  - .3** Main and secondary annunciator are to indicate to authorized building staff and/or Fire Department response the location and event of the fire detectors.
- .8** Manual Stations – Manual stations shall be installed on every floor near every required exit and near the principal entrance to the building.

- .9 Smoke Detector Locations – Smoke detectors shall be provided at the top of each exit stair shaft and in all public corridors serving residential suites. If required for the resident type, in-suite heat detectors and smoke alarms can be provided in lieu of in-suite smoke alarms only. Consult with BC Housing for this requirement. Duct Type Smoke Detectors – Where required to be provided, duct mounted detectors shall be provided where air handling systems serve more than one suite or more than one storey.
- .10 Duct Type Smoke Detectors – Where required to be provided, duct mounted detectors shall be provided where air handling systems serve more than one suite or more than one storey.
- .11 Audibility of Fire Alarm Systems – Audible signal devices are required to be installed throughout the project. The sound pressure level in a sleeping room from a fire alarm audible device shall not be less than 75 dba, when any intervening doors between the device and the sleeping room are closed. Further, the sound pressure level from the fire alarm systems audible signal devices within the floor area shall not be less than 10 dba above the ambient noise level, and no less than 65 dba.
- .12 Visual Signaling Devices - Visual signaling devices shall be provided through public and service spaces in accordance with good design practice and the requirements of the BC Building Code. In addition to the above, for Seniors, Adaptable, and Accessible units, fire alarm signaling devices in suites shall incorporate visual signals (strobes) in addition to audible signals (buzzers).
- .13 Provide for all required interlocks of FA System with door access system.
- .14 Elevator interconnection with the Fire Alarm System shall be provided in accordance with the current edition of CSA B44 - "Safety Code for Elevators and Dumbwaiters". Provide fire alarm signals from the building fire alarm system to each elevator as applicable to the particular installation including the following:
  - .1 Signal representing the smoke detector located in each elevator lobby (excluding the smoke detector at the main recall level) or the building Fire Alarm System.
  - .2 Signal representing the smoke detector(s) located in the elevator lobby at the designated alternate recall level for alternate level recall.
  - .3 Signal representing smoke detectors located in each elevator machine room, control room, machine space or control space. For machine room less elevators the top of the hoistway is typically considered as elevator machine space and must comply with this requirement.
  - .4 Signal representing smoke or heat detectors located at the top of the elevator hoistway.
  - .5 Signal representing smoke or heat detectors located in the elevator pit.
- .15 Installation & Testing – The fire alarm system shall be installed in conformance with CAN/ULC-S524-M, "Standard for the Installation of Fire Alarm Systems" and tested in conformance with CAN/ULC-S537-M, "Standard for the Verification and Testing of Fire Alarm Systems".
- .16 Fire alarm verification must include verification of the transmitted signal between the fire alarm system and the remote monitoring facility. A letter documenting the type of signal received by the monitoring facility must be submitted prior to occupancy. Fire Alarm monitoring facility must receive separate signals for Fire Alarm, Sprinkler Supervisory, Fire Alarm Trouble and Sprinkler Supervisory. The letter must be received prior to Substantial Performance.

## **.10 FIRE PROTECTION – IN-SUITE SMOKE ALARMS**

Smoke Alarms shall conform to CAN/ULC-S531 and be installed on the ceiling as per CAN/ULC-S524 and specific instruction provided by the manufacturer. Smoke Alarms shall be installed in each dwelling unit and in each sleeping room not within a dwelling unit, as per BC Building Code Requirements.

- .1** Smoke Alarms must carry a minimum 5-year warranty within the residential suite areas.
- .2** All smoke alarms within any residential suite must be interconnected within that suite and provided with 120V a/c power supply and battery backup.
- .3** Combination Smoke Alarms with visual signal, strobe light, should be considered for installation within the dwelling units.

## **.11 CARBON MONOXIDE ALARMS**

- .1** Carbon monoxide detection provisions may be required in addition to smoke detection provisions in the residential suites located in building with storage garages or buildings equipped with fuel burning appliances.

## **.12 FIRE DETECTION AND FIRE ALARM SYSTEM ARRANGEMENTS ALLOWING FOR MONITORING OF INDIVIDUAL RESIDENTIAL SUITES (IF REQUIRED)**

- .1** For projects where there is potential risk of damage to in-suite smoke alarms and as confirmed with BC Housing, installation of smoke detectors inside the suites can be considered. Each residential suite shall be provided with a smoke alarm located as per code as well as a smoke detector. The smoke detector shall be connected to a secondary annunciator (LCD panel) in the 24/7 reception/building manager's office and to the main annunciator panel.
- .2** Smoke alarms are not automatically monitored for continuity of power supply nor functionality of the equipment.
- .3** In case any specific smoke alarm device is disconnected or damaged or does not activate for any reason and smoke is generated in any suite, the dedicated in-suite smoke detector connected to and monitored by the fire alarm system will activate, without causing any general evacuation (fire alarm) in the building.
- .4** The fire alarm system will notify the supervisory staff and also the fire alarm monitoring agency with respect to the specific room (number) where smoke has been detected.
- .5** A secondary annunciator (LCD panel) located at the on-site building manager's area shall be provided to allow for quick notification with respect to specific unit.
- .6** When the condition within the suite is verified as potentially hazardous, the supervisory staff will be able to provide immediate assistance to occupants and also to activate the alarm/evacuation signal using local manual (pull) stations.
- .7** If the smoke detector activation is not due to any fire incident the monitoring agency will be informed by the supervisory staff and the fire alarm system will be restored/ reset to its normal stand-by operation.
- .8** In case there is no response from the supervisory staff for a specified period of time as per

code and local fire authorities, the monitoring agency can initiate fire department response or the system can automatically initiate fire alarm evacuation and fire department response. Note that this specific provision will require approval of the authority having jurisdiction.

- .9 Important issues related to the fire (or smoke) monitoring system utilizing fire alarm smoke detectors are as follows:
  - .1 The addressable smoke detectors installed within the residential suites are not required fire detectors and are used as supplemental fire detection- smoke alarm operation monitoring devices provided in addition to the required fire detection devices (i.e. smoke alarms and automatic fire sprinklers) and are not prohibited nor otherwise restricted by the applicable building codes - except as noted below.
  - .2 The smoke detectors within residential suites must not initiate any evacuation fire alarm in the building and shall be programmed as non-latching supervisory devices with specific suite addresses or numbers (i.e. labelled as "smoke- suite 203" for example).
  - .3 Smoke detectors shall be installed in high ceiling areas, close to suite entry where possible, as per their specific listing requirements published by the manufacturer and applicable CAN/ULC-S524.
  - .4 In-suite fire/ smoke detectors must be fully compatible with the fire alarm panel selected for the specific project- consequently the smoke detectors must be of the specific type and model approved by the fire alarm system manufacturer and will typically be supplied with the fire alarm system components.
  - .5 Any protective guards installed with the smoke detectors must be listed and supplied by the fire alarm system manufacturer or local representative/ supplier. Other devices must not be utilized.
  - .6 Smoke detectors located within the residential suites may initiate fire alarm evacuation signal in the entire building only if specifically permitted by the local authority having jurisdiction- i.e. the local fire department. In such case we recommend initiation of the fire alarm evacuation signal activation to be automatic when the "smoke" trouble signal in any residential suite is not acknowledged nor otherwise verified by the trained personnel on duty for **a specific period of time**. Note that this provision will be a subject to separate and project specific negotiations with the local authority having jurisdiction, as part of a specific building permit application or electrical permit application.
  - .7 The basic acceptable and code compliant fire alarm arrangement with residential suite monitoring (or suite smoke detection) is shown, in a simplified form, on the attached schematic drawings SK-1 and SK-2 in this section.
  - .8 Incorporation of this arrangement with the Fire Alarm and Detection system must receive acceptance by the Authority Having Jurisdiction's Fire and Rescue Services and may require a code equivalency.

### **.13 AUTOMATIC POWER OPERATED DOORS:**





- .1 Provide conduit rough-ins and power to the door operator as required. Coordinate with other relevant disciplines.

## 3 Execution



- .1 Air leakage between units shall be minimized by using sealant or foam. Electrical receptacles may be treated using air tight drywall type gasket boxes prior to the installation of drywall.
- .2 Large electrical penetrations (greater than 50 mm diameter) are most effectively treated by boxing out the penetration within the stud cavity, filling with foam, then installing neoprene gaskets around the perimeter of the box. This is used when a double plate party wall provides the sound and fire separation and is required by Code. Refer to [Appendix B - Reducing Air Leakage Between Suites](#).
- .3 The contractor shall provide proper training and commissioning of heat treatment room with a complete test run at the building handover. The contractor shall prepare an operating manual for the Owner /Operator for the operation of this room.

## FIRE DETECTION AND ALARM LEGEND

### FIRE ALARM DEVICES (ADDRESSABLE SYSTEM)

-  – SPOT SMOKE DETECTOR
-  – BELL
-  – STROBE LIGHT
-  – BUZZER WITH SIGNAL SILENCE

### SEPARATE/ INDEPENDENT FIRE DETECTION DEVICES

-  A – SMOKE ALARM C/W 120V A/C POWER SUPPLY & BATTERY BACKUP & SILENCING CONTROLS
-  CO – SMOKE ALARM & CARBON MONOXIDE ALARM C/W 120V A/C POWER SUPPLY & BATTERY BACKUP & SILENCING CONTROLS  
NOTE: USE SMOKE / CO ALARMS IN BUILDINGS WITH FUEL BURNING APPLIANCES OR STORAGE GARAGES
-  CO – SMOKE ALARM & CARBON MONOXIDE ALARM STROBE LIGHT C/W 120V A/C POWER SUPPLY & BATTERY BACKUP & SILENCING CONTROLS  
NOTE: USE ALARMS WITH BUILT-IN STROBE LIGHT IN SUITES DESIGNATED FOR OCCUPANTS WITH HEARING IMPAIRMENT

SK-1

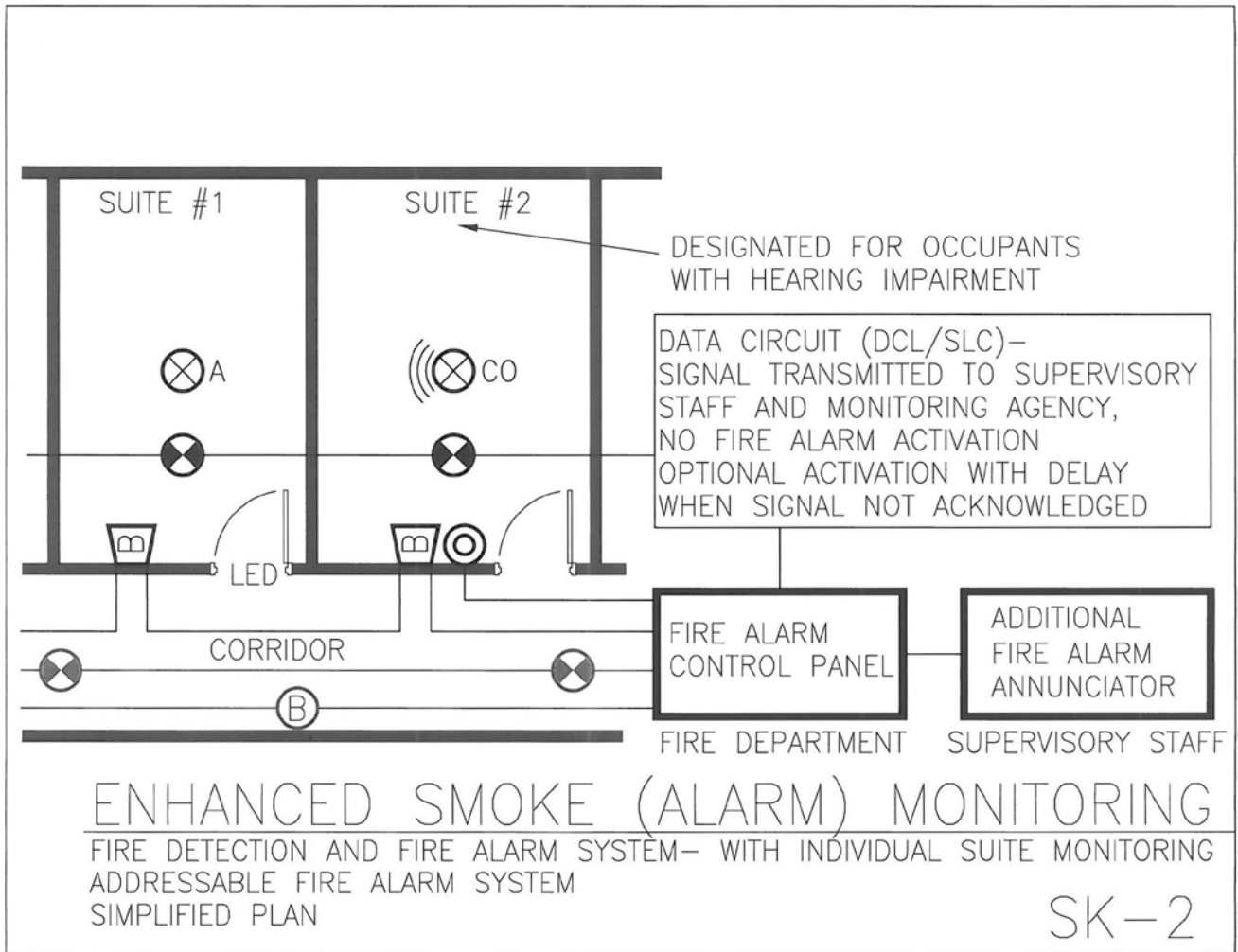

End of Section

# 27 00 00 - Communications

## 1 General

### .1 WARRANTY

Provide full 2 years warranty on all labour and materials for projects under Part 3 buildings for new construction. For Part 9 projects and renovation projects, provide one year warranty. Contractor shall repair or replace any item which proves to be defective due to workmanship, equipment, or materials, without any cost to the Owner.

### .2 TELECOMMUNICATIONS CABLE PLANT

- .1 A complete telecommunications Cable Plant shall be provided. The Cable Plant includes all components to support telecommunications services from the service provider demarcation point to the telecommunications outlet. Contractor to coordinate with service provider all requirements including inspection and commissioning.
- .2 The Cable Plant, as a minimum, shall support all systems mentioned herein (e.g. Intercom System, Cable TV, telephone, ADSL Internet access etc.) services may be copper or fiber.
- .3 Cable plant design and installation shall meet or exceed the recommendations outlined in the following standards (including all any associated addenda):
  - .1 BC Building Code (including variance and bulletins issued by the local authorities)
  - .2 Canadian Electrical Code (including variances by local authorities)
  - .3 TIA/EIA 568B Telecommunications Cabling Standards
  - .4 TIA/EIA 569-D Standards for Telecommunications Pathways and Spaces
  - .5 TIA/EIA 570-B Residential Telecommunications Cabling Standard
  - .6 TIA/EIA 606-C Administration Standard for Telecommunications Infrastructure
  - .7 TIA/EIA 607 J-STD-607-C Telecommunications Grounding Standard
  - .8 .8 TIA-570-B and BICSI TDMM Cable TV Cabling Requirements
  - .9 The telecommunications cable plant and all of its components shall meet or exceed TIA/EIA standards for Category 5e performance.
- .4 **Telecommunication Rooms and Spaces**
  - .1 There shall be one Main Telecommunications room/area. This room/area shall be the location for service provider demarcation points as well as other base building system equipment. The Main Telecommunications Room a security sensitive room and the overall location and door hardware shall be designed to mitigate potential threats.
  - .2 Sub-telecommunications rooms or closets shall be provided as required by TIA/EIA standards to service the building/facility.
  - .3 Fire rated or plywood or fire-retardant painted plywood backboard for the telephone

distribution equipment and wiring shall be provided in the main distribution room and all telecommunication rooms. Fire rated plywood or fire retardant paint shall bear such seal and meet the requirements Authorities Having Jurisdiction. Sub distribution closets shall be provided throughout in accordance with Cable TV and TIA/EIA requirements. Electrical outlet should be provided below or near plywood for equipment connection.

- .4 Equipment such as Digital Video Recorder, Access Control Server, and UPS devices shall be mounted in an equipment rack which is positively connected to the building structure in accordance with the BC Building Code and CSA 832.

#### **.5 Telecommunications Pathways**

- .1 Main Telecommunications shall have conduits to all Sub-telecommunications Room/Closets and the generator area (where applicable).
- .2 Sub-telecommunications Room/Closets shall have conduits to each Suite Demarcation Point.
- .3 Telecommunications outlets (for voice, data or CATV) in common spaces shall have a minimum 25mm (1") conduit to the telecommunications room serving that area.
- .4 Pathways shall have minimum 40% spare capacity.

#### **.6 Backbone Cabling**

- .1 Provide Backbone Cabling for connectivity from the Main Telecommunications Room to the Sub-Telecommunications Room/Closets to support service provider services from the demarcation point to each telecommunications outlet.
- .2 Voice tie cables shall have minimum 50% spare capacity.
- .3 Provide data backbone cabling if required to support voice and data applications. If fibre optic cabling is required, provide 50 micron OM3 multimode fibre as a minimum. Where length limitations exceed that of multimode fibre, provide single mode fibre.
- .4 Cabling run in conduit under slab for in areas that are susceptible to water penetration shall be rated for such installation.
- .5 Cabling routed between buildings shall be rated for such installation and shall have lightning protection on all copper pairs.

#### **.7 Telecommunications Cabling**

In-suite Telecommunications Cabling (see Typical In-suite Telecommunications Cable Plant and CATV Television Wiring diagram herein).

- .1 Each suite shall have a Suite Demarcation Point.
- .2 All in-suite cabling shall have at least Category 5e performance.
- .3 Telephone jacks shall be RJ11/12.
- .4 Data jacks shall be RJ45.
- .5 Resident suites – each resident suite shall be provided with a telephone outlet.
- .6 Each Television Outlet shall have a combined Cable TV and phone jack (refer to Cable TV standards). Consult with BC Housing for specific client group and this requirement.

- .8 Data Communication – telecommunications outlets in common areas shall meet or exceed Category 5e performance for both voice and data applications. Provide data backbone as required (see Backbone Cabling herein). Data jacks shall be Category 5e RJ45 type
- .9 Telephone home runs, horizontal cable, from main or sub-distribution rooms or closets to designated common areas such as offices, resident library/internet and resident lounges shall be minimum 4 pair UTP category 5e via 1" conduit and shall not exceed 90m in length.

### **.3 CABLE TELEVISION (CATV) AND SATELLITE SYSTEMS**

- .1 A complete outlet and wiring system for cable television service shall be provided. All work shall be in accordance with the recommended standards of the local Cable Television Provider and shall allow service delivery from such provider to each outlet.
- .2 Plywood backboard for the television distribution equipment and wiring shall be provided in the main distribution room. Sub distribution closets shall be provided throughout in accordance with Cable Television Provider requirements (see Telecommunications Rooms and Spaces herein).
- .3 All cabling for television shall be provided from demarcation point (main distribution room) to television jacks within the suite. (see Typical In-suite Telecommunications Cable Plant and CATV Television Wiring diagram herein).
- .4 Typical residential suite shall be provided with minimum of two (2) Television Outlets; one located in the master.

### **.4 SECURITY SYSTEMS**

- .1 Security Systems include Access Control, Intrusion Detection and Video Surveillance (i.e. CCTV) Systems.
- .2 Security System Requirements vary significantly with varying threats due to factors such as location, what other facilities are around the building etc. For this reason, the Consultant shall review security issues at the design development stage and incorporate cost effective security systems subject to the review of the Sponsor and BC Housing. The site specific technical requirements for these systems shall be identified during design stage to allow for coordination and inclusion in the contract documents. Measures such as proximity card access systems, closed circuit TV and security alarms should be considered and the related costs shall be identified prior to project commitment.
- .3 All security systems shall be connected to an un-interruptible power supply (UPS) which provides at least 30 minutes of continuous power. The UPS and all Security Systems will be connected to the emergency generator (where applicable). As a minimum, the following Security Systems shall be provided:

#### **.1 Intercom System**

- .1 Provide an Intercom system at the main entrance to buildings with a common entrance as well as other visitor access points such as underground visitor parking. The Intercom master panel shall be located in an area protected from the weather
- .2 The Intercom system shall be a non-subscriber line type c/w call waiting capable of interrupting an active call. The master panel shall be complete with a microphone, built in speaker and directory panel adequately sized to accommodate all residents.

- .3 Each residential unit shall have the capability of receiving calls from the Intercom master panel and releasing the door via the system, except otherwise specified by the Owner. Each resident shall be able to operate the system without the need for a residential phone line from the local utility.
- .4 Intercom panels at entrances shall have an integrated colour camera. The video signal(s) shall be viewable on any television within the building. The number of cameras viewable per channel shall not exceed 4.
- .5 The postal lock in the Intercom shall be controlled through the access control system to be disabled outside of normal mail delivery times.

## **.2 Access Control System**

- .1 There shall be a proximity reader at the main entrance to allow residence entry into the building. The proximity card reader should be located at or near the Intercom panel.
- .2 There should be proximity readers to amenities areas where accessible by general public or other user groups. Areas to consider but not limited to; Main entrances, parkade to building, laundry, common kitchen, gym, storage locker areas, elevator vestibules etc.
- .3 If there is an underground parkade, there should be a RF system to allow residents entry and exit.
- .4 Combination RF and proximity key tags should be used to avoid carrying a keyfob and RF "clicker".
- .5 In locations where cabling of card reader controlled doors may be prohibitive the use of wireless door control hardware should be considered, this would include sites where equipment closet space is limited. When choosing to use a wireless solution the contractor shall undertake an RF survey to determine if there is any interference that could affect the performance of the wireless locks.
- .6 In supportive housing projects for at-risk clients where secured emergency exit doors are required, provide delayed egress function and panic door hardware located in the crash bar, with a hardwired alarm connection to the staff office.

## **.3 Intrusion Detection System**

- .1 The mailboxes shall be monitored. The door position switch on the mailboxes (i.e. used by mail delivery persons) is to be bypassed during regular mail delivery times and armed otherwise.
- .2 A local audible alarm shall sound a local alarm if the mailboxes are breached while armed.
- .3 The intrusion detection shall have the capability of being monitored.
- .4 Each emergency exit only doors shall have a proximity request to exit device. The request to exit device shall monitor door held open and door forced open occurrences and sound a local audible alarm when these occurrences are detected.
- .5 The intrusion system shall monitor the exterior Intercom panel(s) to prevent afterhours access.

#### **.4 Video Surveillance System**

Provide a video surveillance system that addresses the Sponsors security requirements. Refer to BC Housing Guidelines for Placement and Adjustment of CCTV Cameras, CCTV Camera Installation Specification Sheet, and CCTV System Commissioning Checklist. Where required provide as a minimum:

- .1 Cameras at main entry points into the building, including parkade entrances, exit doors, staircase, elevators, common rooms, any exterior storage areas and in the main lobby covering the mail boxes.
- .2 DVR (digital video recorder), located in a secured space, with storage capacity between fourteen (14) and ninety (90) days at 15 fps recording on motion activation for all required cameras.
- .3 Devices and connections necessary to allow residents to view one or more CCTV images on a designated channel of the cable television system.

#### **.5 Personal Call System (for Assisted Living Projects, if required by the Owner and/or Operator)**

- .1 A tenant activated, wireless personal call system to be installed in all the suites and in all common areas.
- .2 A telephone jack (regular analog) and adjacent electrical outlet shall be installed in suites to allow the installation of a personal call system. The Owner will supply in-suite system receiver/communicator capable of voice communication or receiving signals from pendant or bracelet transmitters.
- .3 Where the Operator monitors the system in-house, the system shall be fully integrated (computer, software, receiver, pager, etc.) to receive the signals and send it to the responsible staff. All calls must be monitored 24 hours a day, 7 days a week by the staff.
- .4 The system can be connected to a remote monitoring agency if the Operator do not have 24/7 monitoring staff available.

#### **.6 Security Requirements for Supportive Housing for Homeless At-Risk Clients**

Supportive housing for homeless at-risk clients require different security provisions than other projects. Provide a video surveillance system that addresses the Owner's security requirements. Security Systems include Digital Access Control (i.e. DAC), Intrusion Detection and Video Surveillance (i.e. CCTV) Systems. Consult with the Owner/Operator at the design development stage for project need and incorporate a cost effective security system.

- Provide cameras at main entry points into the building, including all exit and entry doors, all common hallways, staircase, elevator, exterior parking area, common rooms, and any exterior storage areas. The camera monitors should be located in the front entry office. Ensure there are no blind spots on the exterior or interior of the building. Camera locations shall be pre-approved and agreed to by the Owner. Suggested locations are:
  - Around the exterior of the building (no blind spots)
  - Front entry and vestibule
  - Offices and staff areas

- Dining area
- Lounge area
- Meeting rooms
- Laundry rooms
- Corridors and stairwells (includes landings)
- Garbage and recycling area
- Storage entrance/areas
- Amenity areas (indoor/outdoor)
- The front entrance will be monitored 24 /7 by staff. The Owner/Operator needs the ability to control opening/ closing of both sets of entry doors from the front office for residents and visitors. The residents shall have fobs, card reader (depending on Operator's preference) that will allow them to access their suites, and common areas permitted for residents' access.
- DVR (digital video recorder), located in a secured space, with storage capacity at least fourteen and no more than ninety days at 15 fps recording on motion activation for required cameras.
- Back end components shall be installed in a rack to be secured to the wall or floor.
- Interior cameras are to be mounted at a height of 2.3m (7.5') above floor and cameras above front door intercom panels at 1.7m (5.8') above floor unless otherwise specified.
  - Training for site staff to be completed at completion of project.

## 2

## Products

Not Applicable

## 3

## Execution

### .1 LABELING AND IDENTIFICATION

- .1 All panels to be c/w a typewritten circuit directory which shall be set in a metal holder complete with a plastic cover on the inside of the panel.
- .2 Other equipment and apparatus including all switchgear, transformers, disconnects, contactors, junction boxes, fire alarm components, communication equipment, motors, instruments, control devices, incoming service and communication cable shall be labeled, using 118 mm x 31 mm (3/4" x 1-1/4") adhesive lamicoid nameplates.
- .3 A lamicoid label shall be provided naming the Consulting Electrical Engineer. This label shall be located on the main distribution equipment.
- .4 All common area receptacles and switch cover plates to be c/w label indicating panel name and circuit number.
- .5 All recessed junction boxes to be labeled in indelible ink indicating function of junction box

(equipment name, fire alarm, emergency or exit) and panel name and circuit number. Labels to be located on the side of the junction box and on the cover plate.

- .6 All conduits, conductors, wires to be labeled in indelible ink at panel and all junction boxes indicating device being fed, panel name and circuit number.
- .7 Labels shall identify all electrical equipment mounted or connected. Colour coding of conduit, junction boxes, etc. shall be provided.
- .8 Telecommunications cable plant, including CATV wiring system, shall be labeled in accordance of Owner's cable plant administration requirements. Otherwise, label per TIA/EIA 606-C.

## **.2 FIRE, SOUND AND VAPOUR BARRIERS**

- .1 Openings around electrical wireways passing through sound rated walls shall be filled with soundproofing materials.
- .2 Fire stops as required by the current edition of the *BC Building Code* or *Vancouver Building By-Law* shall be provided. Fire stop and smoke seal material shall be used to seal any penetration of compartment separation in concealed spaces. Refer to [Division 07 80 00 - Fire Stopping and Smoke Seal](#).
- .3 Weather and Vapour barriers shall be maintained. All penetrations shall be sealed and made weather and airtight.

## **.3 DRIP SHIELDS**

Where a sprinkler system is installed, all electrical equipment shall have drip shields to protect equipment against water from the sprinkler heads.

## **.4 SEISMIC RESTRAINT**

- .1 Seismic restraint shall be provided for all electrical equipment and accessories including attachment to structural members where required by BC Building Code, CAN/CSA-S832 Seismic risk reduction of operational and functional components (OFC's) in the buildings.
- .2 Letter of Assurance from Structural Engineer on commencement of design and completion of field review shall be provided where required.

## **.5 WIREGUARDS AND POLYCARBONATE GUARDING BOXES**

All equipment and wiring devices, in areas susceptible to damage, including light fixtures, pull stations, exit lights, etc., shall be protected by approved wire guards or polycarbonate boxes. These locations include but are not limited to, storage, janitorial, mechanical, electrical and similar places.

## **.6 MASTER LOCK**

All lockable Panelboards, boxes, sub-distribution panels, etc., shall have common master lock c/w a total of 20 keys

**.7 PLYWOOD BACKING**

Where plywood backing is required, plywood backing shall cover walls from the floor up to 1830 mm (6'-0") A.F.F. and be firmly secured. Plywood shall be minimum 18 mm (3/4") thick Good 1 Side and be fire retardant treated. Where plywood treated plywood is used, ensure that the fire-treated stamp or seal is visible for each sheet of plywood. Where fire retardant paint is used, apply visible stamp or seal certifying such on each sheet of plywood.

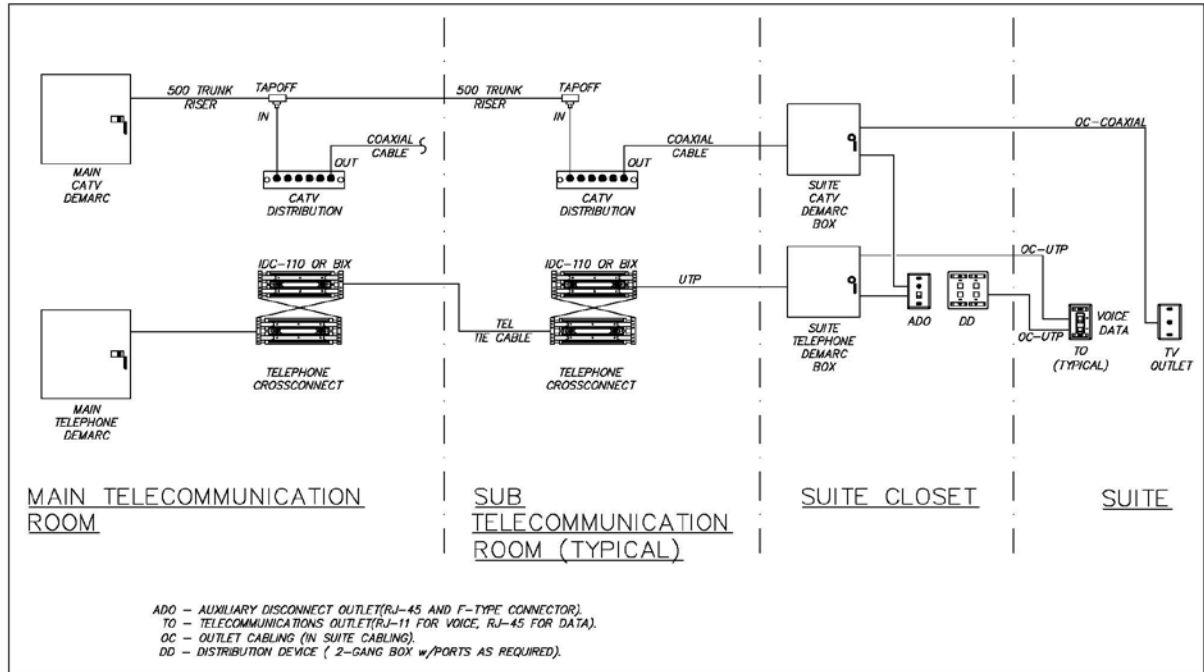

 <p><b>Acumen Engineering</b>                  8177 160th Street, Surrey, BC V4N 1C7                  604-271-8888                  acumenengineering.com</p>	project	BC HOUSING CONSTRUCTION STANDARDS	date:	MAR/2014	scale:	NTS
	dwg title	TYPICAL IN SUITE TELECOMMUNICATION CABLE PLANT AND CATV TELEVISION WIRING	drawn by:	AT	project no.	7086
			checked by:	WB	dwg no.	SKE01

End of Section

# 31 23 00 - Excavation and Backfill

## 1 General

- .1 Comply with the following standards unless the Geotechnical Engineer specifically recommends otherwise.
- .2 Develop and implement an Erosion and Sedimentation Control Plan in accordance with the requirements of the authority having jurisdiction and/or LEED® Canada.
- .3 Review existing site conditions and provide excavation support measures such as shoring, slope protection, underpinning or other retention measures, where required. Arrange for any underpinning agreements with adjacent property owners if necessary.
- .4 QUALITY ASSURANCE**
  - .1 Comply with municipal bylaws and applicable building codes. Comply also with the current Master Municipal Construction Documents as appropriate for all subsurface and paving work.
  - .2 Geotechnical engineer to specify backfill requirements, subgrade bearing, compaction testing and submittal requirements.
  - .3 Contractor to engage and pay for independent testing as specified by the geotechnical engineer.

## 2 Products

### .1 GENERAL

- .1 Fill material must be clean, free-draining, contain no organic matter or other deleterious materials and have less than 5% passing the 75µm (USS 200) sieve size by dry weight.
- .2 Fill materials shall be approved by the Geotechnical Engineer prior to the start of work.

### .2 BACKFILL FOR UNDERSLAB

- .1 19 mm (3/4") minus well-graded crush sand and gravel (base course) with less than 5% passing the 75µm (USS 200) sieve size by dry weight.
- .2 A minimum of 70% of particles with one fractured face when tested in accordance with ASTM D5821.

### .3 GRANULAR ENGINEERED FILL

Well-graded granular mineral material with a maximum size of 75 mm and containing less than 5% passing the 75µm (USS 200) sieve size by dry weight.

#### **.4 BACKFILL FOR FOUNDATION DRAINAGE**

- .1** 19 mm (3/4") clear crushed gravel, free of sand, silt and clay with maximum particle size of 25 mm (1") and containing no particle sizes less than 9.5 mm (3/8").
- .2** A minimum of 75% crushed stone.
- .3** Unless otherwise specified or approved by the owner or engineer, the surface layer of the backfill shall consist of not less than 300 mm (12") thickness of low to moderate permeability materials, consisting of:
  - .1** for soft landscaping areas – topsoil or other mineral material approved by the engineer having at least 10% passing the 75µm (USS 200) sieve size by dry weight or
  - .2** for hard landscaping/paved areas – underslab or granular engineered fills.

In both cases surface fills shall be separated from the backfill by a continuous layer of low permeable geotextile/geomembrane as approved by the engineer.

#### **.5 BACKFILL FOR WATERPROOFED FOUNDATION WALLS**

Well-graded, granular, free-draining mineral material with a maximum size of 75 mm (3") and containing less than 5% passing the 75µm (USS 200) sieve size by dry weight.

#### **.6 FOUNDATION DRAINS**

150 mm (6") diameter rigid perforated ABS pipe to CSA B1800 and B182.1.

## 3 Execution

### **.1 BACKFILL**

- .1** Underslab Fill: Provide a 150 mm (6") layer of 19 mm (3/4") clear crushed gravel and compact to approval of Geotechnical Engineer.
- .2** Backfill waterproofed foundation walls with clean, well-graded, granular structural fill compacted to 90% Modified Proctor (ASTM D1557) Maximum Dry Density (MPMDD) beneath areas which will receive soft landscaping and to 95% MPMDD beneath areas which will receive hard landscaping and paving (concrete, wood, unit pavers and asphalt type).
- .3** On or adjacent to public property, backfill to conform to the above requirements or to those of the Authority Having Jurisdiction whichever is most stringent. Care shall be taken to prevent damage to dampproofing and/or waterproofing materials.

### **.2 FOUNDATION DRAINS**

Provide foundation drains with 300 mm (12") min of drain rock cover extending to the perimeter foundation walls, and completely encapsulated in a nonwoven geotextile providing effective drainage and filtration properties. Slope to drain to suitable collection and discharge location. Provide cleanouts at changes in direction and in pipe runs longer than 15.2 m (50'-0").

End of Section

# 32 12 16 - Asphalt Pavement

## 1 General

- .1 Provide asphalt paving, base and sub-base courses as per requirements of Geotechnical Consultant and subsurface investigation report.
- .2 Confirm geographic conditions, climatic variations and seasonal restrictions when no work should be taken place.
- .3 Quality Assurance
  - .1 Conform to current Master Municipal Construction Document (MMCD) requirements and to geotechnical engineer requirements.
  - .2 Geotechnical or civil consultant to specify independent testing and submittal requirements for roadbase compaction, asphalt mix and installation.
  - .3 Contractor to arrange and pay for all specified inspection and testing.

## 2 Products

- .1 Sub-base course 75 mm minus well-graded pit run sand and gravel with less than 5% fines passing 75µm sieve. Place and compact to 95% Modified Proctor Maximum Dry Density (MPMDD).
- .2 Base course 19 mm (3/4") minus crushed gravel with less than 5% fines passing 75µm sieve. Place and compact to 95% MPMDD.
- .3 Asphaltic Concrete:
  - .1 Hot mix, dense graded, conforming to Upper Course #1 of the MMCD or Class 1 Medium Mix of Ministry of Transportation or local municipal specification, if approved by geotechnical/civil engineer.
  - .2 Provide a minimum 9000N Marshall Stability.
  - .3 Asphalt cement penetration grade 80 – 100.

## 3 Execution

Ensure final asphalt pavement surface is shaped to provide adequate drainage and is free of depressions. Unless noted otherwise the following minimum requirements shall apply:

- .1 **AT PARKING LOT AREAS:**
  - .1 lay sub-base course gravel to a minimum of 150 mm (6") compacted thickness

- .2 lay base course gravel to a minimum of 100 mm (4") compacted thickness
- .3 lay asphalt paving in one layer of 50 mm (2") thickness

## **.2 AT FIRE ACCESS ROUTES:**

- .1 lay sub-base course gravel to a minimum of 150 mm (6") compacted thickness.
- .2 lay base course gravel to a minimum of 100 mm (4") compacted thickness
- .3 lay asphaltic paving to a total of 75 mm (3"); lay paving in two layers – bottom layer 40 mm (1-5/8") thick and top layer 35 mm (1-3/8") thick.

## **.3 COMPACTION REQUIREMENT**

- .1 Roll asphalt pavement to average density of not less than 97% of 75 blow Marshall density with no individual test being less than 95%.

End of Section

## 32 90 00 - Planting

### 1 General

- .1 Quality Assurance: Workmanship and materials must conform to the latest edition of Guide Specification for Nursery Stock as published by the Canadian Nursery Trades Association (CNTA) and Guide Specification for Landscape Construction as published by the BC Nursery Trade Association (BCNTA).
- .2 Warranty: Plant material will remain free of defects for period of one year from the date of Substantial Performance of the Work. Replace all unsatisfactory plant material and continue to replace such plant material until the replacement is acceptable, at no cost to the Owner.
- .3 All plants incorporated into the project shall be accepted by the Owner and/or Consultant.
- .4 Refer to [Section 1 – General Design Guidelines](#) for site design, landscaping, and other landscaping requirements.

### 2 Products

- .1 Plant Material: shall conform to the Canadian Nursery Trade Association Canadian Standards. In particular: Nursery grown stock, grading, size and quality in accordance with BCNTA, legibly tagged using standardized plant names, free of disease, insects, defects or injuries and structurally sound with strong fibrous root systems and well developed branch systems. Trees must have straight trunks, well and characteristically branched for their species.
- .2 The selection of native and/or drought resistant plants is the preferred strategy for all projects. Conform the compatibility to local soil, geographic conditions and climatic variations; local plants native to that region should be recommended wherever possible.
- .3 Sod which requires permanent watering should not be installed unless LEED® Canada can be satisfied. Sod to be Canada No. 1 nursery grown turf from seed, free of diseases, clovers, stones, pests, debris and containing no more than two broadleaf weeds or ten other weeds per 42 m<sup>2</sup> (50 yd<sup>2</sup>).
- .4 Where applicable on previously developed sites, implement strategies to restore a minimum of 50% of the site area excluding the building footprint by replacing impervious surfaces with native or adaptive vegetation.

### 3 Execution

- .1 The Landscape Consultant will inspect all plants including sod before planting commences. Also

plant fertilizers, backfill mixes, mulches and soil amendments will be inspected by the Consultant prior to planting operations.

- .2** The contractor is responsible for plant maintenance, including watering, weeding, the removal and replacement of dead plants and plants not in healthy growing conditions, including sod, for a period of sixty (60) days from the date of the Certificate of Completion for the landscape work or the date of Substantial Performance, whichever is later.
- .3** Plant material will be inspected by the design consultant sixty (60) days after the Certificate of Completion is issued for the landscape work, provided that plant material exhibits healthy growing conditions and is free from disease, insects and fungal organisms.

**End of Section**

section

# 5

## Drawing and Document Requirements

- 
- A detailed architectural floor plan is overlaid on the left side of the page. It shows various rooms, corridors, and structural elements with dimensions and area calculations. Visible area calculations include 1.5m², 4m², 24m², 10m², and 23m². Dimensions such as 1500, 1800, and 3700 are also present.
- Schematic Design Phase
  - Design Development Phase
  - Construction Document Phase

# Drawings and Documents

The following sections outline the minimum drawing and document submission requirements for the three stages of the BC Housing Plan review process. These stages include the Schematic Design stage, the Design Development stage and the Construction Documents stage. The level of detail required for drawings and specifications submitted at these stages are similar to the phases referenced in the *Canadian Standard Form of Contract for Architectural Services*.

In order to reflect the appropriate level of information required for new construction/conversion projects and for renovation projects, the following phases identify the items that are required for the above mentioned projects.

Drawings, specifications, and other required documents at different stages should provide sufficient information to confirm conformity with the BCH Design Guidelines and Construction Standards and to confirm the construction budget.

Drawing scale may be in imperial or the metric equivalent as noted.

## 1 Phase 1: Schematic Design Phase (new construction and conversion projects only)

The purpose of the drawing submission at this stage is to provide sufficient information to evaluate the project's basic design concepts in relation to the program design guidelines and project cost framework.

Submit one (1) set of hardcopy and one set (1) of electronic copy including drawings and specifications.

### 1.1 DRAWING REQUIREMENTS

#### .1 Site Plan (1/16" = 1'-0" or 1:200)

List all applicable required and provided land use by-law requirements and note on the site plan, such as:

- .1 Setbacks
- .2 Building height
- .3 Site area
- .4 Site coverage
- .5 Density (FSR)
- .6 Landscape open space (LOS), gross livable area (GLA), gross floor area (GFA), units per acre (UPA)
- .7 Daylight angles, sun angles (where required by municipality)
- .8 Vehicle and bicycle parking ratios
- .9 Number and type of units including unit sizes

- .10 Residential area, staff area, amenity and program area, circulation and service area, commercial area (if any)

Note: GFA is the total floor area inside the building including parking. GLA excludes parking area. Refer to GLA definition in Section 1.

#### **.2 Floor Plans (scale 1/8" = 1'-0" or 1:100)**

Provide for each level with a different floor configuration. Identify all residential areas, staff areas, amenity and program spaces, commercial areas, service room areas, circulation and stairs.

#### **.3 Typical Unit Plans (scale 1/4" = 1'-0" or 1:50)**

Provide floor plans for all typical unit types and include the following information:

- .1 Furniture layouts – show proposed furniture layouts and clearances
- .2 Turning radii at unit entrance, kitchen, bedroom, bathroom, living/dining
- .3 Note unit area and dimensions of each room
- .4 Cabinet layouts – show configuration, layouts and clearance

#### **.4 Functional Program**

A functional program for the project should be prepared by the project team that identifies the spatial requirements of the user group.

Refer to [Section 1 - General Design Guidelines](#) for the functional programme table.

#### **.5 Social Housing Cost Target Framework**

For new construction projects, the Society's project team shall prepare for review by BC Housing, a completed Cost Target Framework for their proposed building design.

Refer to the Social Housing Cost Target Framework and Costing Framework spreadsheet published in the BC Housing website [www.bchousing.org](http://www.bchousing.org).

## **1.2 SPECIFICATIONS REQUIREMENTS**

The schematic design submission shall include an outline of the basic specifications of the project such construction type, exterior finishes, major interior finishes, and systems description of the proposed mechanical and electrical systems.

If any alternatives to the BCH Design Guidelines and Construction Standards are anticipated, the sponsor's design team should submit a summary of any requested alternatives to the applicable *BCH Design Guidelines and Construction Standards*, in particular, to [Construction Standards](#). To facilitate the review of the proposed alternatives, the list must be accompanied by a brief justification. The justification shall include a review as outlined in the [Division 01 23 00 - Alternatives](#).

## **1.3 SUSTAINABILITY REQUIREMENTS**

Provide a brief description of the major sustainability features of the project.

Submit preliminary energy modeling to demonstrate the energy and environmental targets for the new construction and redevelopment Project. Refer to [Energy and Environmental Design](#) section. The report shall clearly state project name, project address, drawing reference, modelling software and version, a brief building description and details on the building architectural, mechanical and electrical components, and others required for modeling.

Each modelling assumption should provide appropriate details, such as assembly, system type, fuel type, nominal and effective R value, efficiency, capacity and units and identify if the proposed building shall meet the energy target required for the project. Energy modeller shall work with the design team to provide the list of energy conservation measures (ECM) and how it can improve TEDI and TEUI level.

For renovation projects, submit a detailed energy assessment report. The assessment must be completed as ASHRAE level II or a comparable level appropriate for the project scope. The report shall clearly provide a list of ECM recommendations, description of measures, capital cost of implementation, annual cost savings, greenhouse gas (GHG) emission savings, net present value and simple payback period. ECM shall demonstrate how the proposed design meets BC Housing's target for energy conservation and GHG emission reduction goal. Consult with BC Housing representatives. Refer to [Energy and Environmental Design](#) section.

Construction Waste Management Plan shall be submitted prior to any demolition work by the Contractor.

## 2

## Phase 2: Design Development Phase

Submit one (1) set of hardcopy and one (1) set of electronic copy including drawings and specifications.

### 2.1 DESIGN DEVELOPMENT – NEW CONSTRUCTION AND CONVERSION PROJECTS

#### .1 Drawing Requirements

##### .1 Location Plan

Provide a key plan with sufficient information to locate the site.

##### .2 Site Plan (scale 1/16" = 1'-0" or 1:200)

- .1 Cross reference unit types to site plan.
- .2 Land Use Bylaw: list required and proposed land use bylaw requirements; see requirements for the Schematic Design Site Plan. Note setbacks on site plan.
- .3 Site services: show existing and proposed site services located at grade e.g. electrical, gas and water fixtures and sewer catch basins. Confirm required setbacks from electrical services (transformers, high voltage lines).
- .4 Site boundaries: show all property lines, orientation, length and corner pins; refer to survey by registered land surveyor.
- .5 Site topography: note all existing and proposed topographic features (e.g. swales, rock outcrop, watercourses, etc.). Note extent of cutting and filling required (dotted cutouts).

- .6 Grades: show existing and proposed grades at principal corners of the building and property lines, sufficient to indicate drainage patterns. Show spot levels on a grid as required by architect, plot contours at minimum interval of 1 m (3'-3").
  - .7 Show existing grades of adjacent properties and streets to 3.1 m (10'-0") depth of adjacent lot or to centerline of street.
  - .8 First floor grade elevation(s) of proposed structures.
  - .9 Building Plan: note extent of building at grade, ramp gradient, underground garage and roof overhang.
  - .10 Paved areas: note all existing and proposed paved areas and indicate dimensions and materials (e.g. roads, parking including bike and scooter, walks, and patios).
  - .11 Landscaping: note extent of planted areas and existing and proposed trees with trunk diameter over 100 mm (4"); coordinate with landscape plan.
  - .12 Snow storage: in areas with substantial snowfall note designated snow storage areas.
  - .13 Retaining walls, fences and screens: note extent and materials; coordinate with landscape plan.
  - .14 Garbage pad: note pad and enclosure location and dimensions; confirm location with municipal authorities.
  - .15 Heritage, demolition or renovation: note existing buildings to be renovated, restored or demolished and outline scope of work.
  - .16 Recreation area: indicate outdoor recreation area, coordinate with landscape plan.
  - .17 Access for disabled: review and verify compliance with requirements for accessibility for disabled persons.
  - .18 Number and type of units including unit sizes.
  - .19 Gross Floor area, Gross Livable area, residential area, circulation and service area, amenity area, and commercial area (if any).
- .3 Floor Plans (scale 1/8" = 1'-0" or 1:100)**
- .1 Levels: show each level from lowest floor including parking to roof where layout varies.
  - .2 Structural grid: provide lettered and numbered structural grid and dimensions.
  - .3 Rooms: label and provide size of all residential areas, staff areas, amenity and program spaces, commercial areas and service room areas.
  - .4 Stairs and corridors: dimension stairs and corridors; ensure compliance with accessibility requirements.
  - .5 Mechanical/Electrical: coordinate locations of all mechanical and electrical rooms with incoming services. Show rooms such as generator room, transformer room, exhaust and intake shafts, electrical closets, boiler rooms, elevator machine rooms, corridor fresh air shafts, etc.
  - .6 Fire hose / extinguisher cabinets: locate as per building code requirements.

- .7 Mail: note proposed mailbox location.
- .8 Balconies & overhangs: show all balconies, entrance canopy and roof overhangs, roof decks.
- .9 Storage: show all storage locations including tenant & bicycle.

#### **.4 Unit Plans (scale 1/4" = 1'-0" or 1:50)**

- .1 Scope: show all unit types and common rooms (e.g., lounges, laundry and others where applicable).
- .2 Furniture layouts: show proposed furniture layouts and clearances.
- .3 Show door swings.
- .4 Show turning radii at unit entrance, kitchen, bedroom, bathroom, laundry, living/dining.
- .5 Cabinet Details: provide cabinet elevations for all unit types with sufficient detail to verify conformity with the Design Guidelines.
- .6 Mechanical/Electrical shafts: note location of all ducts and vent shafts. Provide for pipe chases in unit plans clear of exterior and party walls.
- .7 Note unit area and dimensions of each room.

#### **.5 Cross Section (scale 1/8" = 1'-0" or 1:100)**

- .1 Grades: note existing and proposed finish grades at section line to centerline of street.
- .2 Elevations: note elevations of all floors, foundations and top of roof.
- .3 Detail sections: locate and cross-reference details on section for details noted in Typical Details (listed below).
- .4 Site Service Areas: provide details on outside garbage enclosure, maintenance area and storage, if any.

#### **.6 Elevations (scale 1/8" = 1'-0" or 1:100)**

Elevations – show all elevations of all buildings and note the following:

- .1 Finish materials: note extent of all finish materials.
- .2 Grades: show finish grade at building.
- .3 Elevations: show top of each floor level and roof and note height.
- .4 Roof slope
- .5 Set back: show set backs on elevations

#### **.7 Typical Details (scale 1-1/2" = 1'-0" or 1:10, or larger as required)**

Provide the following details and describe typical assemblies:

- .1 Foundation wall: from footing to top of slab on grade or suspended slab.
- .2 Suspended slab: at junction with building wall.

- .3 Exterior wall: at grade and typical floor.
  - .4 Window: head, jamb, sill, section and plan detail.
  - .5 Roof: at eaves, roof decks, low slope roofs, and parapets.
  - .6 Building Envelope: describe recommended wall assemblies and window types based on the most recent version of *Woodframe Envelopes in the Coastal Climate of BC: Best Practice Guide Building Technology*, CMHC, Table 5.1, or other relevant standard, where applicable. Document calculations for window ratings. Recommend air barrier, vapour barrier and sheathing membrane materials and assemblies and outline the rationale for the recommended strategy.
  - .7 Provide a single line red marking on drawings to show continuous air-tightness in building envelope.
- .8 Landscape Plan (scale 1/8" = 1'-0" or 1:100)**
- .1 Paving: note extent of all paving for walks, roads, parking and label finish materials.
  - .2 Planting: note planting types: trees, shrubs, sod, groundcover, etc., and clearly indicate extent (species and number of plants to be provided at Construction Documents stage)
  - .3 Indicate extent of irrigation system (non-permanent or permanent).
  - .4 Note existing trees and planting to be retained.
  - .5 Recreation Areas: note play areas, common decks or patios. Indicate play equipment or outdoor furniture as required. Grading: indicate slope to drain, grades at building, roads, walks and site perimeter.
  - .6 Screens/Fences: note extent and provide detail for fence and screen types.
  - .7 Recycling and garbage storage areas.
- .9 Mechanical Drawings:**
- .1 Mechanical site services plan (scale 1/16" = 1'-0" or 1:100) – show all existing municipal services for the site and proposed services.
  - .2 Irrigation system layout. Coordinate with landscape drawings.
  - .3 Overall floor plans (scale 1/8" = 1'-0" or 1:100) – ventilation, plumbing and fire protection layout including riser diagrams, domestic hot and cold water distribution, makeup air control diagram, heating layout.
  - .4 Typical unit plans (scale 1/4" = 1'-0" or 1:50) – HVAC, plumbing and fire protection layouts for all unit types.
- .10 Electrical Drawings**
- .1 Electrical site services plan (scale 1/16" = 1'-0" or 1:100) – existing and new site services including underground power cable, power distribution diagram.
  - .2 Floor plans (scale 1/8" = 1'-0" or 1:100) – lighting, emergency lighting, exit lights, fire protection devices, entry phone/intercom, television cable, and telephone system layouts.

- .3 Typical unit plans (scale 1/4" = 1'-0" or 1:50) – electrical layout for all unit types.

## .2 Specification Requirements

The intent of the outline specifications is to enable BC Housing to confirm conformity with the *BCH Design Guidelines and Construction Standards* and to review any alternatives that the Sponsor may propose to [General Design Guidelines](#) and [Construction Standards](#) sections. The outline specifications should be accompanied by a list that summarizes all alternatives with brief justification as outlined in the [Division 01 23 00 - Alternatives](#). Clarification of proposed alternatives at this stage will expedite the approval of future submittals.

The outline specifications should be presented in CSA MasterFormat 2014 trade divisions and shall describe introductory project information and all major building components, systems and finishes including, but not limited to:

- .1 Contacts: identification of owner, developer (where applicable), design consultants.
- .2 Scope: brief description of the scope of the project: e.g., number of units and type, number of storeys, gross floor area, parking spaces provided, major common areas provided.
- .3 Civil: proposed road works, site drainage, sewage collection and domestic water supply.
- .4 Landscape: paving, planting, fences, and other major landscape elements.
- .5 Structural: structural systems, foundation design, identify any landscape elements that require structural design such as retaining walls.
- .6 Architectural Materials and Systems: describe construction assemblies, finish materials and their integration within the building.
- .7 Mechanical: define the HVAC system, including confirmation of air conditioning, plumbing systems, fire protection and control systems.
- .8 Electrical: outline service and distribution, feeders and wiring, proposed lighting fixtures and light levels, security system, fire alarm system, personal call system, communication system, generators, data and television and emergency lighting. Describe energy conservation measures. Confirm specifications for independent metering for electricity.

## .3 Sustainability Requirements

Pre-construction energy modelling shall be completed at schematic design phase and submitted to BC Housing for review. Also, at the end of Design Development stage (e.g. building permit stage), the energy modelling report shall be updated to incorporate any changes as design/ drawings progress.

Each modelling assumption should provide appropriate details, such as assembly, system type, fuel type, nominal and effective R value, efficiency, capacity and units and identify if the proposed building meet the energy target required for the project. Energy modeller shall work with the design team to provide the list of energy conservation measures (ECM) and how it can improve TEDI and TEUI level.

For renovation project ECM from the energy assessment report shall be incorporated and the proposed design meets BC Housing's target for energy conservation, GHG reduction goal, cost premium and payback. The assessment must be completed as ASHRAE level II or a comparable level appropriate for the project scope. The report shall clearly provide a list of ECM recommendations,

description of measures, capital cost of implementation, annual cost savings, greenhouse gas (GHG) emission savings, net present value and simple payback period. Consult with BC Housing representatives.

Construction Waste Management Plan shall be submitted prior to any demolition work by the Contractor.

## 2.2 DESIGN DEVELOPMENT - RENOVATION PROJECTS

For renovation projects, the design development phase allows for the conceptual repair options to be refined and evaluated, in order to assist the Owner in selecting a preferred repair option for the project. The consultant shall prepare for the Owner's and BC Housing's review and approval one (1) hardcopy and one (1) electronic copy of design development documents and written reports appropriate to the size and nature of the Project to describe the size, aesthetic, and scope of the entire project, including architectural, structural, mechanical systems, materials, and such other elements as may be appropriate.

The design development documents shall include the following items:

- .1 Outline of the program and building occupancy requirements of the Project and the characteristics of the site. Occupancy requirements are to be discussed with the Owner (and BC Housing where they are not the Owner).
- .2 Plans and elevations showing the extent of the scope of work and the areas of the building that will be impacted by the repair.
- .3 Where exterior or interior finishes are being renovated, provide coloured drawings, and/or sketches, and/or pictures of elevations, plans, etc., showing the various conceptual design options, complete with product, material and colour samples.
- .4 Description of the scope of work that will be undertaken and an outline of the impact of those repairs on the building residents.
- .5 List of the specification sections that will be included in the construction documents and any standard detailing that will be utilized.
- .6 A written comparison of the conceptual repair options, by material, discussing performance (including energy performance of building), appearance, maintenance, service life, construction time and cost.
- .7 Discussion regarding code or zoning issues that will impact the scope of work, schedule or cost. It is expected that a full review of applicable statutes, regulations, codes and by-laws, and where necessary review same with authorities having jurisdiction, will be completed during this phase.
- .8 Outline of impact of hazardous material abatement on project design, scope and cost.

## 3 Phase 3: Construction Document Phase

Drawings must be a set of construction documents coordinated for consistency and completeness by all consultants involved in the project. Submit one (1) set of hardcopy and one (1) set of electronic copy.

including bound drawings and specifications.

All drawings must bear the stamp of the appropriate professional.

Construction Documents for renovation projects should include all information relevant to the scope of work that is being undertaken and are to clearly denote existing and new components.

BC Housing review should be undertaken at 50% and 100% completion of working drawings and specifications for new construction/conversion projects, and 75% and 100% for renovation projects, to verify conformity with [Construction Standards](#) section.

### 3.1 DRAWING REQUIREMENTS

#### .1 Site Plan (scale 1/16" = 1'-0" or 1:200)

As outlined in the Design Development stage for new construction and conversion projects, with the following additional information:

- .1 Provide detailed grading at perimeter of building.
- .2 Indicate percent of slope and direction of site drainage to curb (not just to property line).
- .3 Note extent of paving materials and location of drains, catch basins and other features for stormwater management.
- .4 Show retaining walls and note elevations (top and bottom).
- .5 Include all detail, section and window/door schedule references.
- .6 Include legend of all items referenced on the plan.
- .7 For renovation projects, include outline of area of work.

#### .2 Floor Plans (scale 1/8" = 1'-0" or 1:100)

As outlined in the Design Development stage above for new construction and conversion projects, with the following additional information:

- .1 Show drop ceilings for services for areas not shown elsewhere.
- .2 Include all detail, section and window/door schedule references.
- .3 Include legend of all items referenced on the plan.
- .4 For renovation projects, include outline of area of work.

#### .3 Roof Plans (scale 1/8" = 1'-0" or 1:100)

- .1 Indicate all penetrations, percent of slope, drainage pattern, roof drains and roof top equipment.

#### .4 Unit Plans (scale 1/4" = 1'-0" or 1:50)

Provide detail plans of all typical unit types, as outlined in the Design Development stage above for new construction and conversion projects, with the following additional information:

- .1 Room names – room finish schedule.
- .2 Door, window types – door and window schedule.
- .3 Cabinets – kitchen, bathroom elevations.

.4 Show drop ceilings for services.

**.5 Common Areas (scale 1/4" = 1'-0" or 1:50)**

.1 Detail common areas – e.g., lobbies, amenity and service rooms as required.

.2 Show drop ceilings for services.

**.6 Sections (scale 1/8" = 1'-0" or 1:100 for high-rise; 1/4" = 1'-0" or 1:50 for low-rise, 4 storey or less)**

.1 Full sections from footings to roof to show typical exterior wall sections and non-typical conditions where wall plane changes or low roofs occur.

.2 Cross reference sections on plans.

.3 Details – cross reference all typical details at sections, e.g. foundation, wall, window, and roof.

.4 Assemblies – cross reference all typical floor and roof assemblies.

.5 Note the following (or cross reference to details) to show:

.1 Existing and proposed grades.

.2 Foundation drainage requirements as per geotechnical requirements.

.3 Roof and slopes.

.4 Window and /patio door sections.

.5 Floor to ceiling heights and elevations of all floor levels.

.6 Include legend of all items referenced on the plan.

.7 For renovations, include outline of area of work.

**.7 Elevations (scale 1/8" = 1'-0" or 1:100)**

.1 Show all exterior elevations including portions of buildings hidden on the principal elevations, e.g. courtyards.

.2 Grade – note existing and finish grade line.

.3 Floor elevations – note all levels and top of roof.

.4 Walls – note elevation at top of foundation and retaining walls.

.5 Materials and finishes – note all exterior materials and finishes including railings, trim, and flashing.

.6 Roof slopes – note all roof slopes.

.7 Doors and windows – note all door and window openings, indicate hinge location; provide sufficient information for windows to locate head and sill heights.

.8 Mechanical vents and louvers – locate all vents and louvers and coordinate with mechanical, including roof vents.

.9 Lights – locate all wall mounted electrical fixtures and coordinate with electrical.

.10 Roof drainage – show all gutters and rain water leaders.

.11 Details – cross reference details as required.

.12 For renovations, include outline of area of work.

**.8 Detail Sections (scale 1-1/2" = 1'-0" or 1:10, or larger as required)**

.1 Waterproofing – provide three-dimensional sequential details for assemblies such as windows, doors, saddle conditions, exhaust vents and balconies to give a clear indication of the installation of the building envelope components in these assemblies (e.g., flashing, membranes, building paper, vapour barrier, air barrier, caulking, etc.).

.2 Provide a single line red marking on drawings to show continuous air-tightness in building envelope.

.3 Provide details for continuous air barrier and continuous insulation (CI). A detail shall be prepared for all air barrier interface and thermal bridging locations, clearly showing how continuity is maintained.

.4 Wall, Floor and Roof construction – provide wall, floor and roof type schedule; note assembly components and any required ratings, including Sound Transmission Class (STC) and fire resistance rating. Provide BC Building Code or Underwriters Laboratory of Canada (ULC) ratings and numbers.

.5 Wall/shaft sections – show non-typical conditions (i.e. those not shown on full cross or longitudinal sections) including changes in wall plane, low roofs, elevator shafts, garbage chute, penthouse, garage ramps, exhaust shafts, etc.

.6 Stair details – provide cross section at party walls and typical tread.

.7 Windows – show head, jamb, sill for all conditions. Detail sections to indicate waterproof membrane, building paper, thermal breaks, flashing, caulking and show continuity of air and vapour barrier.

.8 Non-typical openings – provide details at grilles and louvers, etc.

.9 Miscellaneous metal – railings, ladders, special fabrications.

.10 Shafts, bulkhead – provide details for all horizontal and vertical rated shafts and non-rated bulkheads (e.g., mechanical - plumbing and duct enclosures and drop ceilings).

.11 Roof types – provide detail sections through all typical roof types at eaves, low roof at wall junctions and penetrations.

**.9 Stair Details (1/4" = 1'-0" or 1:50)**

.1 Stair shafts – show all exit stairs and indicate rise/run dimensions, headroom and landings; section and plan detail required.

.2 Show railing height and material.

.3 Landing and tread – note and dimension non-slip nosing and tactile warning strips as required.

**.10 Window Schedule (1/4" = 1'-0" or 1:50)**

- .1 Elevations – note all window types, including dimensions, height above finish floor, operable portions, hinge location, direction of slide or swing, and glazing type.
- .2 Ensure operable portion of unit windows are easily accessed, i.e. less than 1219 mm (4'-0") above finish floor; note latch height above finish floor and confirm latch location with specified manufacturers.

**.11 Door Schedule (elevation 1/4" = 1'-0" or 1:50; frame detail 3" = 1'-0" or 1:5)**

- .1 Elevations of all door types.
- .2 Frame types – jamb section of all frame types.
- .3 Schedule – include door dimensions, hinges, frame types, glazing, hardware, fire rating and any special installation requirements, e.g. threshold, weather-strip, closer, panic set, etc.

**.12 Cabinet Details – Kitchen, Bathroom, Common Areas (scale 1/4" = 1'-0" or 1:50)**

Provide cabinet elevations for all unit types (kitchen and bathroom) and common area cabinets (e.g. amenity and laundry).

**.13 Room Finish Schedule**

- .1 Scope – provide room finish schedule for typical suite and for all common area rooms; cross reference to floor plan room names and numbers.
- .2 Note floor, wall, and ceiling finish.
- .3 Include subfloor, base and ceiling height; note drop ceilings where applicable.

**.14 Structural Drawings (scale 1/8" = 1'-0" or 1:100)**

- .1 Overall footings, suspended slab plan and sections and foundation plans.
- .2 Overall floor construction plans.
- .3 Roof construction plans, including roof truss layout.
- .4 Sections and details of structural connections.
- .5 Columns, beams, wall and lintel schedules (sizes and reinforcements).
- .6 General design notes on loads, e.g., snow, earthquake, etc.
- .7 Spacing, size, construction of control joints (both horizontal and vertical).
- .8 Details to include miscellaneous metal fabrication and related code and submittal requirements.
- .9 Shear wall and tie-down details, if any.

**.15 Mechanical Drawings (scale as noted)**

- .1 Mechanical site services plan – show all existing and new services, their sizes, invert elevations, etc. (scale 1/16" = 1'-0" or 1:100); show storm water disposal arrangement. Mechanical consultant is to obtain the inverts, sizes and status of all existing services from utility or municipality.

- .2 Overall floor plans with ventilation (exhaust and make-up) forced air heating ducts, plumbing and fire protection layouts (scale 1/8" = 1'-0" or 1:100).
- .3 Typical unit plans (scale 1/4" = 1'-0" or 1:100) – HVAC and plumbing layouts for all unit types.
- .4 All riser diagrams for services listed above.
- .5 Domestic hot and cold water distribution and fire protection diagrams; include sprinklers, standpipes, fire hose cabinets, etc.
- .6 Irrigation system layout. Coordinate with landscape drawings.
- .7 Make-up air control diagram and details of make-up air unit.
- .8 Heating layout drawings – coordinate with framing plans to minimize drop ceilings.
- .9 Plumbing fixtures – cross reference plumbing fixtures to the mechanical specifications. Refer to [Division 22 00 00 - Plumbing](#).

#### **.16 Electrical Drawings (scale as noted)**

- .1 Electrical site services plan (scale 1/16" = 1'-0" or 1:100). Detail underground power cable installation, site lighting, type and detail of installation, etc.
- .2 Overall floor plans with lighting, emergency lighting, exit lights, fire protection devices, entry phone/intercom, television cable, and telephone system layouts (scale 1/8" = 1'-0").
- .3 Typical unit plans (scale 1/4" = 1'-0" or 1:50) – electrical layout for all unit types.
- .4 All riser diagrams for services listed above.
- .5 Power distribution diagrams.
- .6 Details of emergency power supply.
- .7 Main distribution panel for typical apartment and other panel diagrams (including laundry, mechanical room, etc.); include estimated power consumption load.
- .8 Electrical light fixtures – cross reference light fixtures to the electrical specifications. Refer to [Division 26 00 00 - Electrical](#).

#### **.17 Landscape Drawings (scale 1/16" = 1'-0" or 1:200)**

Add the following information to the Landscape Concept Plan:

- .1 Lighting – note site lighting locations.
- .2 Drainage – note swales, area drains, co-ordinate with mechanical.
- .3 Details – provide details for all landscape elements including planting, paving assemblies, fences and screens, planters, retaining walls, etc.
- .4 Outdoor furniture – note type and location.

### **3.2 SPECIFICATION REQUIREMENTS**

Provide full specifications organized according to the CSA MasterFormat 2014 trade divisions adopted by Construction Specifications Canada, prepared by a qualified construction specification

writer. Incorporate relevant standards from the *BCH Design Guidelines and Construction Standards*, [Construction Standards](#). Note that these standards are not intended to be used as project specifications.

The Architect/Design Consultant is to ensure that sub-consultants' specifications and contract administration requirements do not conflict with the architectural/design specifications. Include a copy of the Geotechnical Report in the appendix of the specifications and, in the case of design tender projects, the report shall be included in the bid documents. For renovation/conversion projects, a copy of the hazmat survey must be included.

### 3.3 SUSTAINABILITY REQUIREMENTS- NEW CONSTRUCTION AND CONVERSION PROJECTS

Energy modelling shall be completed at schematic design phase and submitted to BC Housing for review. Also, at the end of Design Development stage (e.g. building permit stage), the energy modelling report shall be updated to incorporate any changes as design/drawings progress as well. If required by BC Housing (optional), the energy modeller may need to update the report if there has been changes after submitting the building permit and before issuing the tender package.

Each modelling assumption should provide appropriate details, such as assembly, system type, fuel type, nominal and effective R value, efficiency, capacity and units and identify if the proposed building meet the energy target required for the project. Energy modeller shall work with the design team to provide the list of energy conservation measures (ECM) and how it can improve TEDI and TEUI level.

For renovation projects, submit a detailed energy assessment report. The assessment must be completed as ASHRAE level II or a comparable level appropriate for the project scope. The report shall clearly provide a list of ECM recommendations, description of measures, capital cost of implementation, annual cost savings, greenhouse gas (GHG) emission savings, net present value and simple payback period. ECM shall demonstrate how the proposed design meets BC Housing's target for energy conservation and GHG emission reduction goal. Consult with BC Housing representatives. Refer to [Energy and Environmental Design](#).

Construction Waste Management Plan submitted prior to any demolition and/or construction work by the Contractor.

End of Section

appendix

# A Hazardous Material General Information

- 
- Hazardous Material General Information
  - WorkSafeBC Regulations
  - Potential Locations for Asbestos Materials
  - Owner and Employer Requirements
  - Disturbing Hazardous Materials
  - Additional Considerations

# 1 Hazardous Material General Information

Conducting building maintenance, repair, renovation, or demolition may disturb hazardous materials, especially materials containing asbestos, **lead, heavy metal, or are toxic, flammable or explosive**. There are strict **requirements** that control the management, identification, disturbance, transport and disposal of hazardous materials to prevent exposure to workers.

This **appendix** provides a quick overview when disturbing hazardous materials to establish safe working conditions and provide additional information.

BC Housing is committed to reducing, minimizing, or eliminating the potential hazards posed to individuals as a result of working with or around hazardous materials including asbestos-containing materials. Additional information can be found at BC Housing website: <https://www.bchousing.org/partner-services/asset-management-redevelopment/asbestos-management-training>

Properties and buildings may contain several types of hazardous materials, some of these materials are in limited quantities in housing complexes, and others like asbestos remain throughout the building and may contain high concentration.

In general, a hazardous material is considered safe and does not pose a health risk when it is intact and in good condition; **however it** does cause a health risk when physically disturbed (i.e. cut, drilled, damaged, removed, **repaired**, etc.).

# 2 WorkSafe BC Regulations

In British Columbia, the control and disturbance of all hazardous materials, is regulated by WorkSafeBC's Occupational Health and Safety Regulations.

It is the responsibility of each employer to ensure that no worker is exposed to a substance that exceeds WorkSafeBC's regulations. There are several Parts of the regulations that are to be referred to when disturbing hazardous materials:

- **Part 5's guidelines:** Contains the Table of Exposure Limits for Chemical and Biological Substances for workers disturbing materials like asbestos and lead.
- **Part 6:** Regulations for the disturbance of chemical and biological substances (asbestos, lead, silica, etc).
- **Part 8:** Regulations for personal protective clothing and equipment, specifically the requirements for respiratory protection.
- **Part 20:** Regulations for construction, excavation and demolition, specifically the requirements for testing materials and submitting a Notice of Project **for Asbestos or Lead**.

WorkSafeBC **Regulations:** <http://www2.worksafebc.com/Publications/OHSRegulation/Home.asp>

As mentioned for Part 20, before beginning any work that disturbs hazardous materials like asbestos and lead, WorkSafeBC is to be notified:

- **Notice of Project - Hazardous Substances, NOP:** Written notification submitted to WorkSafeBC for each project initiated with proposed work activities involving hazardous materials including asbestos and lead. The submittal is to include site specific work procedures, tentative schedule, and location.

### 3 Potential Locations for Asbestos Materials

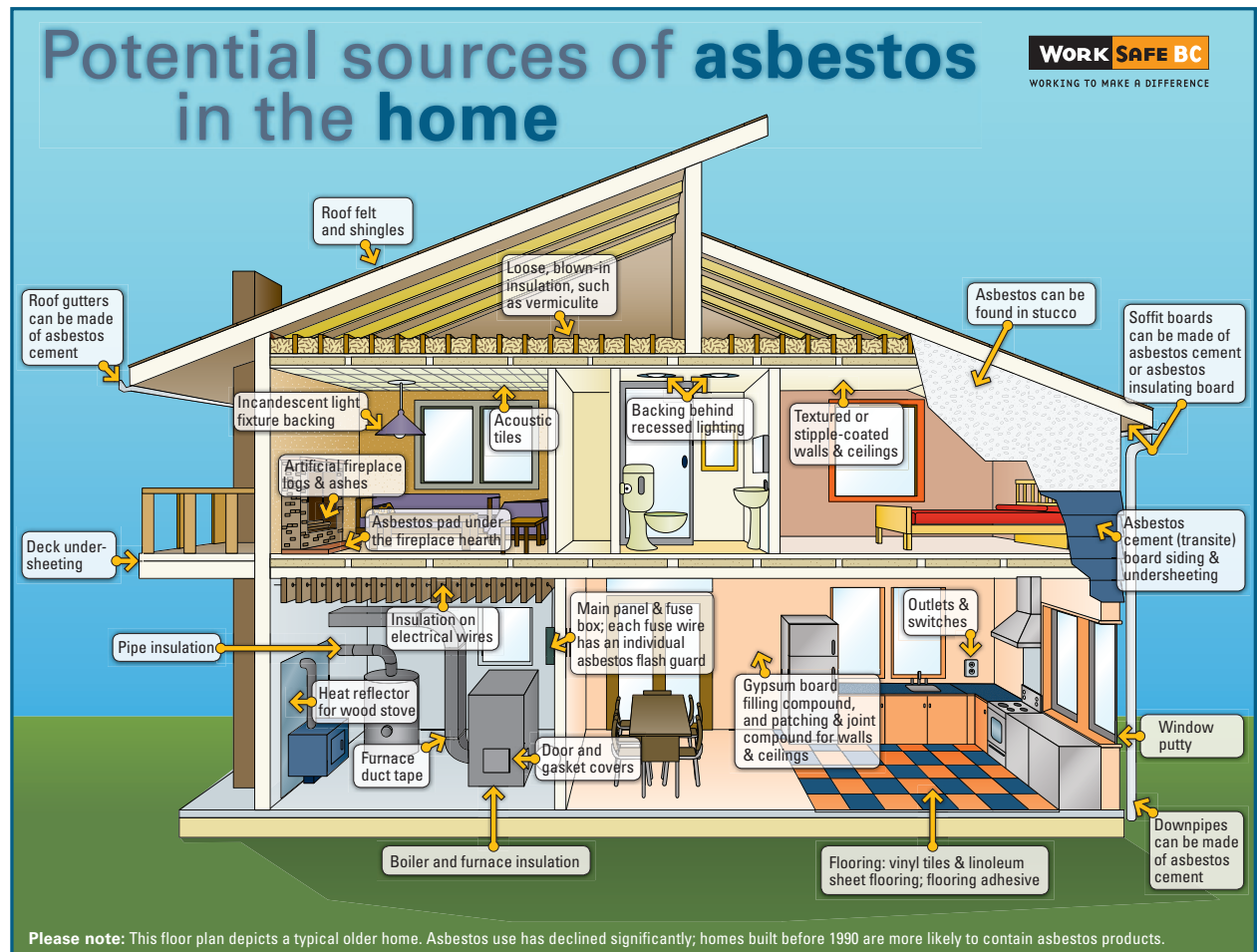

© WorkSafeBC. Used with permission.

### 4 Owner and Employer Requirements

Property Owners (BC Housing and Housing Providers) and **Employers (Consultants and Contractors)** are responsible for **coordinating and** informing workers of known hazards on the property and in the building. For asbestos, WorkSafeBC requires an inventory to be maintained that documents building materials that have been sampled and tested for the presence of asbestos. The inventory is to include summary and conclusion statements which provide clear, easy to understand instructions of what **materials** contain asbestos.

BC Housing maintains inventories for many properties; these can be viewed by registering and logging into BC Housing's Hazardous Material Website: <http://hazmat.bchousing.org>

Where **hazardous materials are present**, as a minimum, the Owner should have the following information available for their staff as well as **other Employers**.

- **Exposure Control Plan (ECP):** Provides guidance and instruction to workers regarding training, education, roles and responsibilities, risk assessment, notice of project, inventory, label &

identification, personal protective equipment, and work procedures.

- **Asbestos (or Hazmat) Inventory:** Provides details on the presence or absence of any identified asbestos containing materials. Review the inventory prior to starting work activities and inform workers of hazards.
- **Awareness:** Inform workers of the presence of the hazardous material, any health hazards and related diseases if exposed to the hazard, and what to do if it is to be disturbed.

Owner's that have staff performing work to materials containing asbestos will need to meet the same requirements as stated in **Employer** Requirements. In addition, when asbestos materials remain in place, tenants should be provided with general information to not disturb these materials and what to do if **they become** damaged.

Owners should inform Employers of, or make arrangement to identify, all hazardous materials in the work area. All hazardous materials, whether known or concealed, must be identified by either the Owner or the Employer to comply with the regulations. Identifying all the hazardous materials prior to a tender or before starting a project is the most cost-effective method when retaining a contractor.

## 5 Disturbing Hazardous Materials

Property Owners (BC Housing and Housing Providers) and **Employers (Consultants and Contractors)** are responsible for coordinating and informing workers of **all hazardous materials in the work area**.

Where ***hazardous materials are to be disturbed*** in addition to the ECP requirement above, as a minimum, the **Owner and Employer must** have the additional documentation available:

- **Hazardous Material Inspection:** A qualified person reviews the work area and conducts an inspection to identify all hazardous materials, including potentially concealed materials, and issues a written report stating what materials contain a hazard, how the material was determined to be a hazard (sample info), the materials location and quantity, if that material is to be disturbed as part of the work, and what controls will be required when the material is disturbed.
- **Exposure Control Plan:** Includes a risk assessment conducted by a qualified person to review the hazardous material(s), scope of work, and other factors in order to determine the level of protection required for **all** workers, public, and environment. **The exposure control plan explains the work procedures and controls required to reduce exposure based on the risk assessment.**
- **Safe Work Procedures:** Developed after the risk assessment, it establishes how to perform the work safely. Each 'type' of job, i.e. drilling &/or fastening into drywall, fixing floor tiles, patch/repair, clean-up, emergency work, etc should have a safe work procedure.
- **Worker Training:** Supervisors and/or workers should be able to provide proof of training and education. The training/education should be to a level acceptable for the work being performed by the worker.
- **Respirators & Fit Testing:** Trained workers are required to have a personal respirator and be trained in its maintenance, use, and limitations. Workers are to be fit tested annually and be able to provide a valid certificate. Facial hair is not allowed to disrupt the seal between the respirator and the skin.

- **Tools and Equipment:** Trained workers are to be provided with the appropriate tools and equipment required to perform the work and for their personal protection, safety of other workers, safety of the building and safety of the public.
- **Notice of Project for Hazardous Substances:** Submitted electronically to WorkSafeBC a min. 48 hours in advance of work being performed to hazardous material such as asbestos, lead, and silica. A copy must be posted at the work site.
- **Air Sampling (If Applicable):** If air sampling is completed, copies of the air sample results are to be analyzed and returned to the job site within 24 hours.
- **Written Confirmation:** A worker who has the appropriate education, training, and experience must issue the written confirmation document that states the work area, where the hazardous materials were disturbed, is now safe to enter. It must also include if this is based on a visual assessment or air sampling.

At the end of the project, WorkSafeBC wants Owners to have a copy of the following records:

- Hazardous Material Inspection;
- Exposure Control Plan and Safe Work Procedures;
- Notice of Project;
- Written Confirmation; and
- Information necessary for Owner's to update the asbestos inventory to ensure it is current and up to date.

Reminder to Owner's to update their hazardous material inventory, where applicable, once the project is completed to identify any new hazardous materials and/or to identify where materials have been removed.

For additional information on the items above, refer to:

- WorkSafeBC Searchable OHS Regulations & related materials: <https://www.worksafebc.com/en/law-policy/occupational-health-safety/searchable-ohs-regulation>
- BC Housing's Housing Provider Guide for a Contractor Safety Program: <https://www.bchousing.org/partner-services/asset-management-redevelopment/contractor-safety-program>
- WorkSafeBC's Asbestos website: <http://www.hiddenkiller.ca>

## 6 Additional Considerations

Whether performing routine maintenance, renovations, repairs, demolition or coordinating and arranging for work to be completed. the following information is a guideline and should not replace the requirements of WorkSafeBC.

### 6.1 KNOW YOUR SCOPE OF WORK

Its best if the Owner, Consultant, and Contractor know the location(s) and extent of the work to be

complete prior to reviewing the inventory or arranging for additional sampling or a **hazmat survey**. Anticipate what areas and materials may be impacted when completing the scope of work. The benefits for this is that it can reduce costs, reduce risks, prevent delays, and prevent exposure.

## 6.2 RETAINING A CONSULTANT FAMILIAR WITH HAZARDOUS MATERIALS

There are several advantages to retaining an environmental consultant early on a project to collaborate and provide information. The Consultant can provide additional advice on sampling requirements, conduct risk assessments, establish contractor requirements, and as necessary conduct reviews and collect air samples.

## 6.3 CHECK THE INVENTORY / PREVIOUS SURVEY

The Owner may already have completed a representative survey for hazardous building materials and developed an inventory of known hazards. Where no previous survey has been completed, a survey may be required due to the age of the building, refer to ADDITIONAL SAMPLING REQUIREMENTS with respect to requesting a survey.

If an inventory does exist for the property, review the inventory (or report) to see that it contains information for the material within the scope of work, such as:

- Asbestos
- Heavy Metals (Incl. Lead)
- Lead based paints
- Mercury
- Ozone Depleting Substance (ODS)
- Polychlorinated Biphenyl (PCB)
- Radioactive / Radiofrequency

Not all hazards may be listed on the inventory and these may need to be addressed prior to starting construction, this includes but not limited to:

- Wall, floor and ceiling cavities may not have been accessed during the representative survey and may conceal and/or hide materials that require testing.
- Sharps & needles, animal droppings and carcasses, biological (i.e. bacteria), and mould may also be present.

## 6.4 ADDITIONAL SAMPLING REQUIREMENTS

Additional sampling may be required to determine if a material poses a hazard, especially for asbestos and lead containing materials, and/or there are gaps in the inventory between the scope of work and materials sampled.

If the inventory is not comprehensive enough, it may be needed to complete the following:

- For larger projects: Prior to tender, recommend an additional detailed survey be conducted with the defined scope of work to more accurately determine hazards and associated costs.

For smaller projects: Either arrange for an additional survey or if the scope of work is small enough, request the contractor, if qualified, to collect samples for analysis of suspect or unknown materials.

When requesting a survey, generally there are 3 types of surveys that can be conducted:

- **Representative (or occupied) Sampling – Typically/Standard:** Typically used to develop an inventory as it is non-destructive and checks most building materials and usually does not include entering accessible cavities and opening up walls for hidden materials.
- **Non-Destructive Sampling – Request:** Will check and enter accessible cavities, bulk heads, etc. for hazardous materials.
- **Destructive Sampling – Request:** Will open-up wall, floor and ceiling spaces to check for hazardous materials. Best for projects commencing shortly and the scope of work is defined.

WorkSafeBC provides a Bulk Material Sample Collection Guide in their publication [Safe Work Practices for Handling Asbestos](#) (pg 27, 2012 Edition). The bulletin, Sampling for Asbestos, provides some general guidelines for the quantity of each sample to be collected.

## 6.5 KEEP THE ASBESTOS (HAZMAT) INVENTORY CURRENT

After completing additional sampling or survey for asbestos, update or create the inventory with all materials sampled. Housing Providers can submit a copy of the inventory to [amp@bchousing.org](mailto:amp@bchousing.org) to act as a repository. This will ensure all the information is in one place and prevent re-sampling of the same materials.

Upon completion of the project, the inventory should be kept current by updating the inventory spreadsheet or by the contractor filling out and submitting the Contractor's Hazardous Material Management Tracking form. The contractor is required to submit the updated inventory list as part of Closeout Procedures; Refer to [Division 01 78 00 - Closeout Submittals](#).

## 6.6 AIR SAMPLING DURING WORK ACTIVITIES

Air sampling may be required to check a workers exposure to a hazardous material such as asbestos, lead, mould, and silica. A qualified person can inform the Owner if air sampling is required, the type of air sampling necessary and the frequency of it.

For asbestos, air monitoring is not required for low-risk and moderate-risk work activities when performed by trained workers using strict work procedures and the regulations they are governed by; however, there may be a need to conduct some air sampling if:

- working in a tenanted or occupied building. Air sampling at the beginning of the project can prove that effective measures are in place to protect workers, tenants and public; or
- large amounts of asbestos are to be removed. Air monitoring may be required as there is a potential for generating enough fibres to pose a health hazard.

Air sampling is mandated by WorkSafeBC for high-risk work activities, they are monitored closely to ensure asbestos fibres do not migrate out of the enclosure and that workers are adequately protected.

## 6.7 RETAINING A CONTRACTOR

Contractors must be appropriately trained and educated in disturbing hazardous materials. Employers should review a contractor to ensure the contractor is capable of performing the work appropriately and safely.

## 6.8 DOCUMENTATION TO REQUEST FROM A CONTRACTOR

The following documentation is to be available at the job site at all times, BC Housing requests a copy be provided as well:

- **Hazardous Material Inspection;**
- **Exposure Control Plan;**
- **Work Procedures;**
- **Notice of Project (NOP);**
- **Respirators & Fit Testing;**
- **Worker Training;**
- **Written Confirmation of removal or containment; and**
- **Air Sampling (if applicable)**

For BC Housing directly managed properties, the hazardous material inspection, exposure control plan, safe work procedures, notice of project, and the written confirmation must be submitted to [ohs@bchousing.org](mailto:ohs@bchousing.org).

## 6.9 WASTE GENERATOR

When removing waste from a property, depending on the quantity being removed, the contractor may require the waste generator number. This is a requirement from the Ministry of Environment to track which property the hazardous waste came from.

Small amounts of appropriately bagged asbestos containing materials may be stored on sites in a secure and labelled container. When the container is full, arrange for the waste to be disposed of in accordance with BC Ministry of Environment, Lands and Parks regulations, and Transportation of Dangerous Goods (TDG) Legislation.

Contact the Recycling Council of BC for information regarding recycling facilities across the province for local disposal of waste (<https://rcbc.ca/>, 1-800-667-4321, [hotline@rcbc.bc.ca](mailto:hotline@rcbc.bc.ca))

For Provincial Rental Housing Corporation (PRHC) properties, contact BC Housing representative responsible for the project for the BCG#. For non-PRHC properties, the property owner will need to supply the BCG # or request one from the [Ministry of Environment](#).

## 6.10 WASTE MANIFEST FORMS FROM THE CONTRACTOR

The waste manifest form documents the generation of the hazardous waste, and is proof that it was transported and disposed of in accordance with regulations.

- For PRHC properties, a copy of the waste manifest form is to be sent to BC Housing, email [ohs@bchousing.org](mailto:ohs@bchousing.org)
- For non-PRHC properties, a copy of the waste manifest form is to be sent to the Owner of the property.

## 6.11 COMMUNICATING WITH TENANTS

Owners have a responsibility to appropriately advise tenants on the precautions that should be taken when asbestos containing materials are present in a living space. As a precaution, tenants must not be present in the suite/room while asbestos work is being performed nor shall they be allowed to return until **the written confirmation is issued**.

A few template letters for communicating with tenants are available on BC Housing website under the [Asbestos Management Program](#) Step 2 page, under the Information and Template section.

The extent to which a tenant is advised about potential asbestos containing materials within their building must be reviewed and should be based on the potential exposure risk to that tenant. Care must be taken to not create undue stress and anxiety among tenants.

- If 'friable' asbestos containing materials remain and they are located in areas easily accessible to tenants, then tenants must be advised about the need to maintain these materials in good repair and to promptly report any damages.

For BC Housing managed properties, communication plans in this area should be communicated and coordinated through the Property Portfolio Manager, Maintenance Manager, and/or Building Manager Supervisor.

**End of Section**

appendix

# B Reducing Air Leakage Between Suites

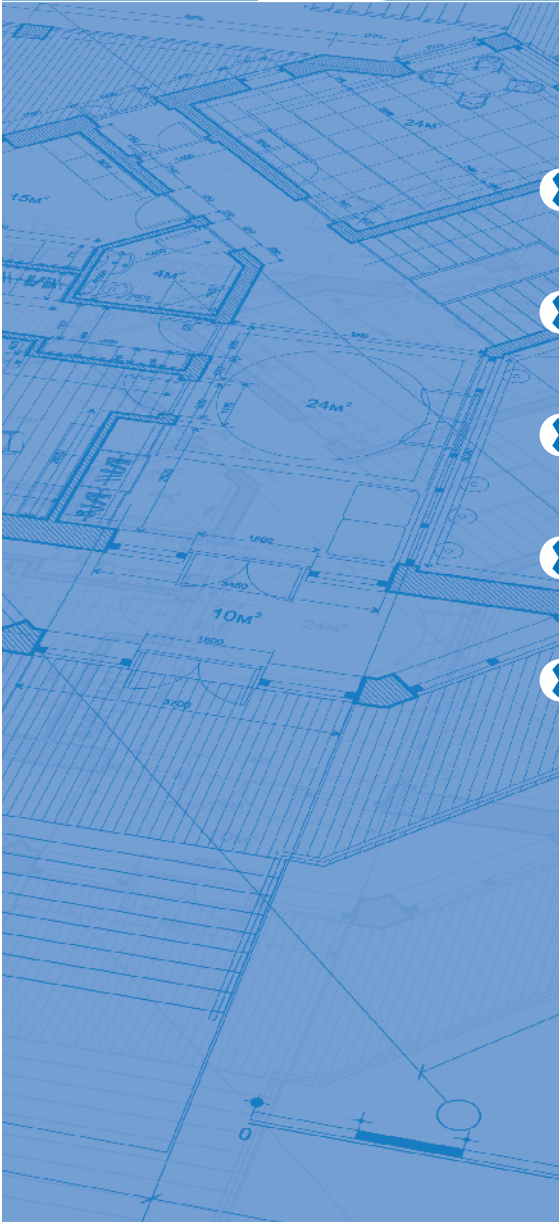

- ▶ Background
- ▶ Typical Air Leakage Areas
- ▶ Approach and Air Sealing Details
- ▶ Unit Airtightness Testing
- ▶ References

# 1 Background

Air movement from floor to floor and suite to suite is relatively common in multi-unit residential buildings. While smoke and fire control measures are implemented, little other attention is given during construction to ensuring the air tightness of internal partitions. Limiting the amount of uncontrolled air movement within the building will improve building performance by

1. reducing tobacco smoke and odour transfer between suites
2. enhancing smoke and fire integrity between zones
3. preventing bed bug infestations
4. minimizing paths for sound transfer between suites
5. permitting better sizing of in-suite ventilation and space conditioning systems, thus energy and cost savings
6. enhancing occupant comfort, health and safety

While the intrinsic benefits of air leakage control within buildings are relatively well-understood, there is little practical knowledge available regarding how easily internal partitions between suites, and between suites and common areas could be sealed. This appendix has been developed to assist Design Team and Contractor with a focus on reducing air leakage/smoke and ensuring bed bug control between suites in BC Housing projects. BC Housing requirements for Interior Partitions Air Leakage Rate ( $IPALR_{n50}$ ) is  $1.2 \text{ l/s/m}^2$  at 50 Pa. Refer to Energy and Environmental Design.

The appendix provides general guidance only and is not intended to replace professional site specific requirements. The Consultants (including mechanical and electrical consultants) will provide the details on interior suite air-tightness in the project specifications and drawings. The contractor shall have relevant experience in air-leakage control training and experience, and the different types of construction (for example, wood frame vs. masonry vs. steel studs).

# 2 Typical Air Leakage Areas

While each building will be somewhat different, the location of significant air leakage is usually the same. Here are some common locations of air leakage within the interior partitions:

- Stairway, corridor doors
- Bottom/top plate to the floor/ceiling slab
- Plumbing risers, and stack penetrations through floor levels
- HVAC duct risers through partition walls and floors
- Garbage chute door and access hatches
- Wiring raceways through walls and floors
- Wall-floor and wall-ceiling joint in service areas such as, mechanical room, electrical room, common areas and suites
- Elevator doors
- Electrical outlets

### 3 Approach and Air Sealing Details

Air leakage between suites can be minimized through



1. Sealing of penetrations in floors, ceilings and walls
2. Air sealing vertical chases located adjacent to units
3. Weather stripping the suite access door

A range of approaches may be applied to minimize air leakage between units, including

1. Sealed polyethylene air/vapour barrier installation
2. Air tight drywall
3. Installation of closed cell expanding foam in conjunction with typical drywall installation

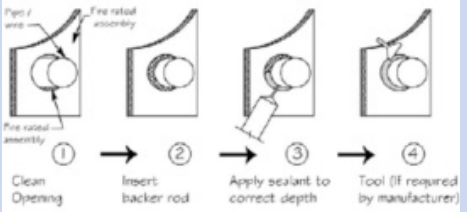
The table below provides potential leakage points and sealing options to address interior compartmentalization of MURBs. In addition to sealing the interior walls, continuity of the exterior air barrier is critical too. Envelope air barrier details are not included in this table or appendix.

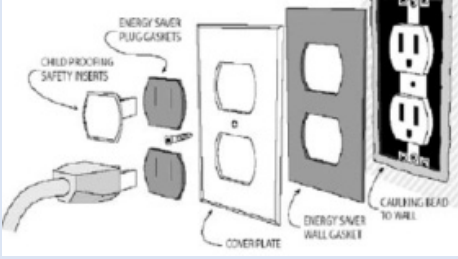
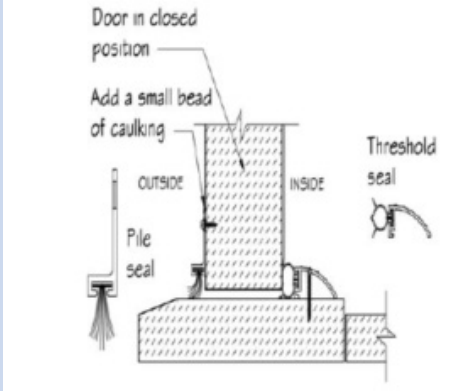
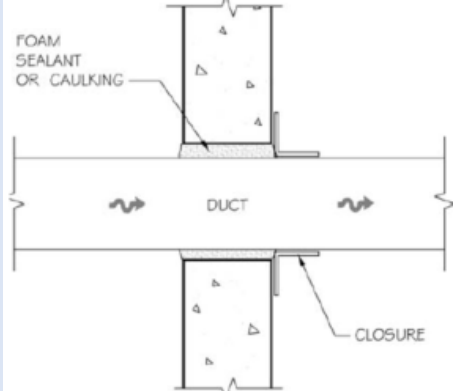
LOCATION	DESCRIPTION	DETAIL
<p><b>Seal Bottom/top plate to the floor/ceiling slab</b></p>	<p>Foam Sealant installed after drywall installation. Sealant is recommended for joints from 3 mm to 20 mm. Foam sealant is recommended for joints between 20 mm and 75 mm. Alternatively, the slab to wall joint may be treated by sealing the bottom plate/top plate to the slab, then using neoprene gasket to seal the drywall to the plates.</p>	
<p><b>Plumbing/electrical fixtures</b></p>	<p>Plumbing and electrical penetrations may be treated similarly using sealant for small joints and foam for larger joints. Fire rated foam may be used to achieve both air leakage control and fire stopping.</p> <p>Large electrical or plumbing penetrations (greater than 50 mm diameter) are most effectively treated by boxing out the penetration within the stud cavity, filling with foam, then installing neoprene gaskets around the perimeter of the box. This is used when a double plate party wall provides the sound and fire separation and is required by Code.</p>	

LOCATION	DESCRIPTION	DETAIL
<p><b>Electrical Receptacles</b></p>	<p>Electrical receptacles may be treated using air tight drywall type gasketed boxes prior to the installation of drywall.</p> <p>In situations where the drywall has been installed, pre-punched neoprene gaskets may be installed.</p> <p>In cases where the fit between the electrical box and the drywall is poor, foam may be installed to seal the joint</p>	
<p><b>Door weather stripping</b></p>	<p>A range of products are available for jamb, head and sill details.</p> <p>In applications where accessibility precludes the use of a sill threshold, a pile seal may be considered to provide the necessary air sealing. As entrance doors are self latching, ensuring the door can operate properly with the door weather stripping should be confirmed.</p>	
<p><b>Transfer grille fire dampers</b></p>	<p>Transfer grilles installed in walls for supply air may be sealed between the duct and the wall. If the transfer grille is installed in the door, it should be sealed between the duct and the door. In general transfer grilles require a fire damper when installed between the suite and corridor.</p> <p>Testing of the fire damper in the closed position should be included in assessing the overall air tightness of units.</p>	
<p><b>Pocket Doors</b></p>	<p>Pocket doors connected to partition walls may provide a significant air leakage path unless the stud space is compartmentalized. Boxing in and air sealing the pocket door rough opening is recommended, as it is difficult to air seal pocket door once installed.</p>	

LOCATION	DESCRIPTION	DETAIL
<b>Supply and Exhaust Ducts</b>	<p>Seal duct to flange and flange to wall connections of supply and exhaust ducts. Ensure that duct grilles are equipped with flaps or dampers to prevent back flow.</p> <p>Joints in ducting can be a significant source of air leakage that may be addressed through specifying maximum duct leakage, and installing joint seals in all duct joints.</p>	
<b>Stacks and vents</b>	<p>Vertical stacks for water and sewer lines may run within party walls and provide floor to floor air leakage paths. In general these penetrations are fire sealed.</p> <p>A range of fire rated foam products are available that meet fire rating and air seal requirements and may be considered for these applications.</p>	
<b>Plumbing fixtures</b>	<p>Plumbing fixtures may be treated as other large penetrations. They are most effectively treated by boxing out the penetration within the stud cavity, filling with foam, then installing neoprene gaskets around the perimeter of the box. This detail is required by code when configured back to back but frequently gets omitted in single sided applications.</p>	
<b>Drop Ceiling</b>	<p>Drop ceiling frequently provide runs for electrical, plumbing and ventilation runs. As such they can be difficult to air seal prior to closing in. However, they are almost impossible to treat once drywall is up.</p> <p>It is recommended to install wiring within sleeves that can be sealed once rough in is complete. Similarly, it is recommended to install collars or flanges in ducts as they penetrate walls and seal the flanges to the walls.</p>	

LOCATION	DESCRIPTION	DETAIL
<b>Party Wall to Exterior Wall</b>	<p>The interface between the building envelope air barrier and compartmentalization of interior units can be a complex detail to achieve continuity of air barriers.</p> <p>To ensure continuity, it is recommended that the envelope air barrier be tied to the party wall air barriers.</p> <p>In general a structural air barrier is recommended to ensure a durable system, precluding the use of polyethylene sheet.</p>	

## 4 Unit Airtightness Testing

Along with whole building Envelope Air Leakage Rate testing as required by the Provincial Energy Step Code, airtightness of suites is to be tested and reported for residential buildings and must demonstrate compliance with a suite-level air-leakage target as tested to ASTM E 779 or equivalent standard. The sample set shall require testing of at least 10% of total units and be representative of the variety of unit types in the building; at least one from each floor; at least one middle and corner units. The air tightness testing result shall be submitted to the Consultant by the Contractor at substantial completion.

To identify the exact locations of air leaks, hand inspections, smoke puffers or thermography (infrared cameras) can be used. Once the air leakage locations have been identified, the contractor should document, and prioritize in an order that reflects the ease of doing the work and also work on the air leakage control strategy with a focus on the most significant leaks.

Provide the airtightness testing process and result as follows, but not limited to:

- Building and site details,
- Test arrangement,
- Sample unit locations,
- Blower door testing results before and after corrective or remedial work, noticing the sources of exact air leakage and remediation method.

## 5 References

The test procedures to demonstrate compliance:

ASTM-779-03, Standard Test Method for Determining Air Leakage Rate by Fan Pressurization

CBSB 149.10.M86, Determination Of The Air-tightness Of Building Envelopes By The Fan Depressurization Method

A range of documents have been prepared to assist with air sealing and compartmentalizing buildings:

[Canada Mortgage and Housing Corporation, Air Leakage Control in Multi-unit Residential Buildings](#)

[City of Calgary, Fire Stopping Service Penetrations in Buildings, Version 1.0](#)

[BC Housing, Illustrated Guide - Achieving Airtight Buildings](#)

End of Section

appendix

# C

## HVAC Strategies For BC Housing Projects

- 
- ▶ General
  - ▶ Recommendations for Acceptable HVAC Systems

# 1 General

- .1 Passive design strategies as outlined in BC Housing Design and Construction Standards - [Section 2 Energy and Environmental Design](#), shall be **fully explored** before choosing complex mechanical systems, which would be difficult to maintain and service.
- .2 Energy Step Code requirements, including maximum Thermal Energy Demand Intensity (TEDI) and Total Energy Use Intensity (TEUI), as defined in [Section 2 Energy and Environmental Design](#), shall be used as targets for meeting Building and Energy Performance. Strategies for meeting these targets shall be identified and verified through mandatory building energy modeling. Energy modeling shall comply with requirements of **the current** Provincial Energy Step Code and the City of Vancouver Modelling Guidelines.

Effective building envelope thermal performance used in the building energy modelling shall be calculated in accordance with the Building Envelope Thermal Bridging Guide and shall account for: clear wall heat losses, heat losses through linear interfaces with major components (slabs edges, parapets, corners, windows perimeters, etc.) and point transmittance heat losses (beams, structural penetrations, anchors, etc.). Where the Project Design Team includes the Envelope Consultant, he should be responsible for calculating the effective envelope thermal performance.

- .3 **Envelope** Air Leakage Rate (EALRn75) and Interior Partitions Air Leakage Rate (IPALRn50) targets, as defined in [Section 2 Energy and Environmental Design](#), shall be verified through mandatory testing in accordance with the requirements of the Provincial Energy Step Code.
- .4 Projects located in the City of Vancouver and requiring rezoning are subject to requirements of the City of Vancouver Green Buildings Policy for Rezoning. This includes, among other things, additional Greenhouse Gas Intensity (GHGI) targets.
- .5 Mechanical systems shall be easy to understand by the Operators and easy to operate. In remote locations, HVAC equipment, which cannot be serviced by local trades, should be avoided.
- .6 Maintenance and service costs, as well as the equipment lifetime and replacement costs, shall be considered in choosing **all major components** of HVAC systems for the project.
- .7 The intention of BC Housing guidelines is to align temperature comfort requirements for non-mechanically cooled buildings with the City of Vancouver Energy Modelling Guidelines. HVAC systems for residential suites without mechanical cooling or only partial cooling (e.g. where ventilation air is mechanically cooled) shall be designed to maintain indoor operative temperatures within 80% acceptable limits as per the current edition of ASHRAE Standard 55 "Thermal Environmental Conditions for Human Occupancy", Section 5.3.

It shall be demonstrated that 80% acceptability limits are not exceeded for more than 20 hours per year for any zone.

- .8 Ventilation of the residential suites shall comply with the requirements of Part 9 "Housing and Small Buildings" Section 9.32 "Ventilation" of BC Building Code and Vancouver Building By-Law. This applies to Part 9 and Part 3 Buildings.

Designers are encouraged to **consider** increasing ventilation rates above the minimum code requirements, if it can be achieved without a significant cost premium and **within the requirements**

of Energy Step Code. This should be, in particular, explored for buildings where smoking is not prohibited inside residential suites or where ventilation air is providing partial mechanical cooling for meeting temperature comfort requirements.

## 2 Recommendations for Acceptable HVAC Systems

### .1 PROJECTS NOT REQUIRING FULL AIR CONDITIONING IN RESIDENTIAL APARTMENTS

HVAC systems covered by this section can be considered for the Lower Mainland & Vancouver Island and for the North Regions where full mechanical cooling is not required. This shall not result in summer overheating and not meeting the ASHRAE Standard 55 comfort compliance.

Typically, residential apartments with the north and east exposure will not require mechanical cooling in these locations. Buildings with south and west exposure can easily overheat in summer, if mechanical cooling is not utilized. In this case, special care shall be taken in selecting passive methods of limiting solar gains such as external shading and windows' solar performance. Using windows with SHGC of 0.3 or less for the south and west exposures is recommended, if mechanical cooling is not utilized.

Considering climate changes and warmer summers, it is becoming more and more evident that at least partial mechanical cooling should be considered for residential apartments in the Climate Zones where, traditionally, no mechanical cooling was provided in the past.

The following components can be used for the HVAC systems without full mechanical cooling for residential apartments:

#### .1 Electric Baseboard Heaters for Heating:

Utilizing electric baseboard heaters with wall mounted thermostats for heating of residential suites (without the mechanical cooling option) can be acceptable in the Lower Mainland and Vancouver Island locations.

Electric baseboard heaters shall be located under windows and be heavy duty commercial construction with a 20-gauge cold rolled steel front cover and brackets to limit vandalism.

Electric baseboard heaters shall be controlled by line voltage wall mounted thermostats. Thermostats controlling electric heaters with 1,500 W or more output per one area, shall be programmable thermostats with a setback control option.

Refer to BC Housing Design Guidelines & Construction Standards, [Section 4 - Division 23 - Heating, Ventilation and Air Conditioning, Sub-section 2.2 Heating Systems](#) (2.2.1 Electric Heating)

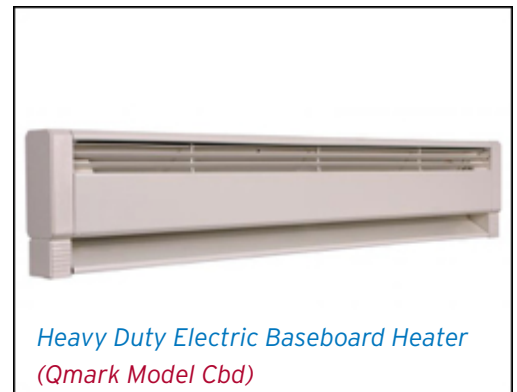

*Heavy Duty Electric Baseboard Heater  
(Qmark Model Cbd)*

## .2 Hot Water Heating:

Hot water heating option can be used in any Climate Zones. Depending on the envelope performance, it can replace the Electric Baseboard Heaters Option for the regions where Heating Degree Days (HDD) are over 4000 (Climate Zones 6, 7 & 8) **as a solution providing lower building operating costs.**

Hot water boilers used for hot water heating shall be condensing boilers with minimum 94% Annual Fuel Utilization Efficiency (AFUE).

Hot water should be distributed through hot water baseboard heaters or in-floor heating. Opportunities of utilizing supplementary heating from heat pump systems (providing cooling and low temperature heating) should be evaluated on projects using hot water heating.

Refer to BC Housing Design Guidelines & Construction Standards, [Section 4 - Division 23 - Heating, Ventilation and Air Conditioning, Sub-section 2.2 Heating Systems](#) (2.2.3 Hot Water Boilers, 2.2.4 Hot Water Baseboard Heating & 2.2.5 Infloor Heating).

## .3 Energy Recovery Ventilators (ERVs) for Ventilation:

### OPTION 1: Central or Semi-Central Energy Recovery Ventilators

Where practical, central Energy Recovery Ventilator(s) are a preferred option for providing ventilation. Exhaust air shall be ducted to a central energy recovery air handling unit from all bathrooms in residential suites. Supply air shall be distributed to all bedrooms and living areas. For larger buildings, multiple central ERVs may be considered to limit sizes of distribution ductwork.

Providing a separate central ERV for the amenity and office areas **in the building** should be considered to allow shutting down this ventilation system during the night-setback mode.

Adding supplementary heating and mechanical cooling for a central ERV is recommended under this option.

For smaller buildings, utilizing a standard gas-fired or heat pump rooftop unit integrated with a separate heat recovery ERV can be considered as a cost-effective solution for providing a central ventilation system with heat recovery and supplementary cooling / heating options.

A semi-central hybrid option of utilizing a single ERV for a number of residential apartments can also be evaluated. It is recommended to use a central or semi-central ventilation system for the studio type apartments, as it is not practical and cost effective to use individual in-suite ERVs for a single room apartments.

Ventilation rates for central and semi-central ERVs shall be minimum 23L/S (49cfm) for studio and one-bedroom apartments, 30l/s (64cfm) for two and three-bedroom apartments with a single bathroom and 47l/s (100cfm) for three-bedroom apartments with two bathrooms.

**Where central or semi-central Energy Recovery Ventilators are provided with mechanical cooling, increasing minimum ventilation rates for the apartments facing south and west can be considered as means of providing better partial cooling during the summer season. Where practical, oversizing the capacity of ERVs and distribution ductwork can be considered as additional means of increasing partial cooling capacity. In this case, ERVs would operate at a lower speed during the heating season and would automatically increase speed to provide more cooling during the cooling season.**

Refer to BC Housing Design Guidelines & Construction Standards, [Section 4 - Division 23 - Heating, Ventilation and Air Conditioning, Sub-section 2.6 Ventilation](#).

### OPTION 2: Individual In-suite Energy Recovery Ventilators

Individual in-suite ERVs shall utilize exhaust air ducted from bathrooms to pre-heat outdoor air ducted to living areas.

Ventilation units for apartments with single bathrooms shall be sized for minimum 17L/s (35cfm) air flow at the continuous low speed and 33 L/s (70 cfm) at the high speed when activated by a switch in a bathroom.

Ventilation units for apartments with two bathrooms shall be sized for minimum 24L/S (50cfm) at the low speed and 47L/S (100cfm) at the high speed. Round 150 mm (5") diameter concentric adjustable grilles, either ceiling or wall mounted, are recommended for exhaust and supply air distribution.

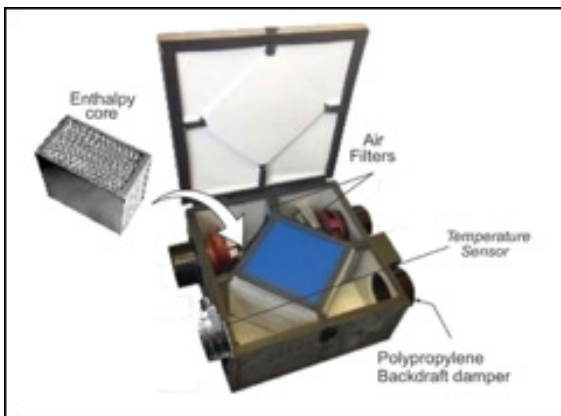

*Reversomatic RERV-80 (Mini)*

ERVs shall be provided with Electronically Commutated Motors (ECMs) and shall be installed to allow easy and unobstructed access for maintenance and servicing.

ERVs with enthalpy core heat exchangers are recommended in most cases as they transfer moisture and do not require condensate drains.

**The minimum Apparent Sensible Effectiveness (ASE) of an ERV shall be 75%.**

Refer to BC Housing Design Guidelines & Construction Standards, [Section 4 - Division 23 - Heating, Ventilation and Air Conditioning, Sub-section 2.6 Ventilation](#).

## .4 Air Conditioning for Amenity / Office Areas:

Unless addressed by implementing passive design strategies, **full** mechanical cooling shall be provided on all BC Housing projects for the amenity and office areas.

Depending on the building's size, there are several solutions for providing mechanical cooling for the amenity / office areas on projects where full air-conditioning of residential suites is not required. In order to meet the Energy Step Code requirements, these HVAC systems shall include a variation of a heat pump system to provide an efficient source of cooling and heating for the part of the building containing the amenity and office areas. This includes:

- **Central air-to-water heat pump system** utilized as a source of cooling and heating for low profile, ceiling mounted fan coil units serving the amenity and office areas. Simpler two-pipe switchover cooling / heating systems are preferred over four-pipe heat recovery systems. The option of pre-heating domestic hot water from the heat pump system should be considered. Due to complexity and high cost of maintaining air-to-water central heat pumps, this option should be considered for larger size projects only, mostly in Climate Zones 4 & 5.

Refer to BC Housing Design Guidelines & Construction Standards, [Section 4 - Division 23 -](#)

[Heating, Ventilation and Air Conditioning, Sub-section 2.3.2 Air-to-Water Heat Pumps.](#)

- **Geothermal heat pump system** can be considered if it can be cost effective and where it can contribute to meeting the energy efficiency targets.

This system can utilize water-to-water heat pumps, distributed water-to-air heat pumps or a combination of both. The option of pre-heating domestic hot water from the heat pump system should be evaluated. This system can be considered for medium to large size projects in all Climate Zones.

Refer to BC Housing Design Guidelines & Construction Standards, [Section 4 - Division 23 - Heating, Ventilation and Air Conditioning, Sub-section 2.3.3 Geothermal Heat Pumps.](#)

- **Split heat pump systems** including: Single-Zone Mini-Split Heat Pump Units, Multi-Zone Mini-Split Heat Pump Units and Multi-Zone Mini-VRF Heat Pump Units, can be considered as an efficient source of cooling and heating for smaller to medium size projects in all Climate Zones. Refer to descriptions of these systems in Section 2.2.

## .2 PROJECTS REQUIRING FULL AIR CONDITIONING IN RESIDENTIAL APARTMENTS

Full air conditioning of the residential suites will be, typically, required in the Southern Interior Region. It may be required in other regions if passive methods of limiting solar gains (exterior shading, windows with low SHGC) cannot be utilized and residential apartments cannot meet the ASHRAE Standard 55 comfort compliance.

The following HVAC systems can be considered for the projects where full air conditioning of residential apartments is required:

### .1 Split Heat Pump Systems:

Split heat pump systems include: Single-Zone Mini-Split Heat Pump Units, Multi-Zone Mini-Split Heat Pump Units and Multi-Zone Mini-VRF Heat Pump Units. These systems can be considered for small to medium size projects.

Each of these systems can be considered for providing heating and cooling in any Climate Zone. There are a number of suppliers to choose from as these systems gain popularity due to a reasonable cost and good energy efficiency performance.

The following criteria shall be considered in choosing these HVAC systems:

- All outdoor units shall be provided with DC inverter compressor.
- Ductless wall mounted fan coils are preferred for indoor units.
- No remote wireless controllers are allowed. All thermostats shall be hard-wired, wall mounted, easy to operate thermostats.
- Selected heat pump equipment shall be capable of providing all heating requirements without a need for auxiliary electric heating. Units installed in colder Climate Zones shall be provided with a low ambient option.
- Separate ventilation system using ERVs shall be provided (refer to Section 2.1.3).

**Single-Zone Mini-Split Heat Pump Units:**

Each zone will be provided with a single, self-contained system. This will require a sufficient wall space outside each residential apartment for mounting of the outdoor unit and might not work well for buildings with a large number of apartments.

This system can be considered for cooling & heating of “non-typical”, single zone areas, such as dining or lounge areas.

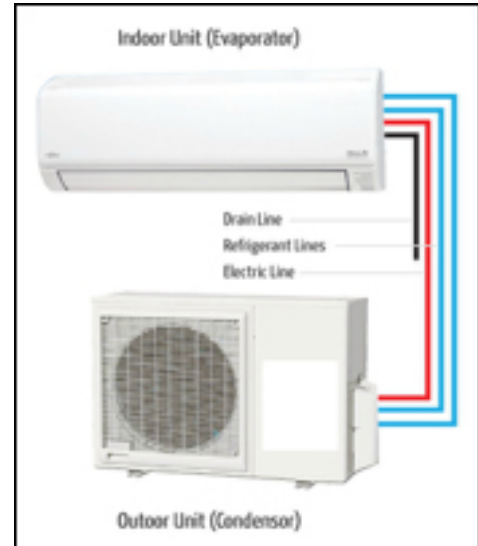

*Schematic of Single-Zone System*

**Multi-Zone Mini-Split Heat Pump Units:**

This system reduces a number of outdoor units. Typically, one outdoor unit can serve up to five indoor fan coils and is limited to 4-tons capacity.

Each individual fan coil unit will require a “homerun” refrigerant piping connection to the outdoor unit. Individual zones served by a single outdoor unit should face the same orientation as all fan coil units can operate in either heating or cooling mode at any given time. Outdoor units should be located, preferably, on the roof of the building.



*Schematic of Multi-Zone Mini-Split System*

**Multi-Zone Mini-VRF Heat Pump Units:**

This system reduces a number of outdoor units even further. Typically, one outdoor unit can serve up to nine fan coil units and is limited to 5-tons capacity. It also significantly reduces amount of refrigerant piping as “homeruns” from each fan coil to the outdoor unit are not required.

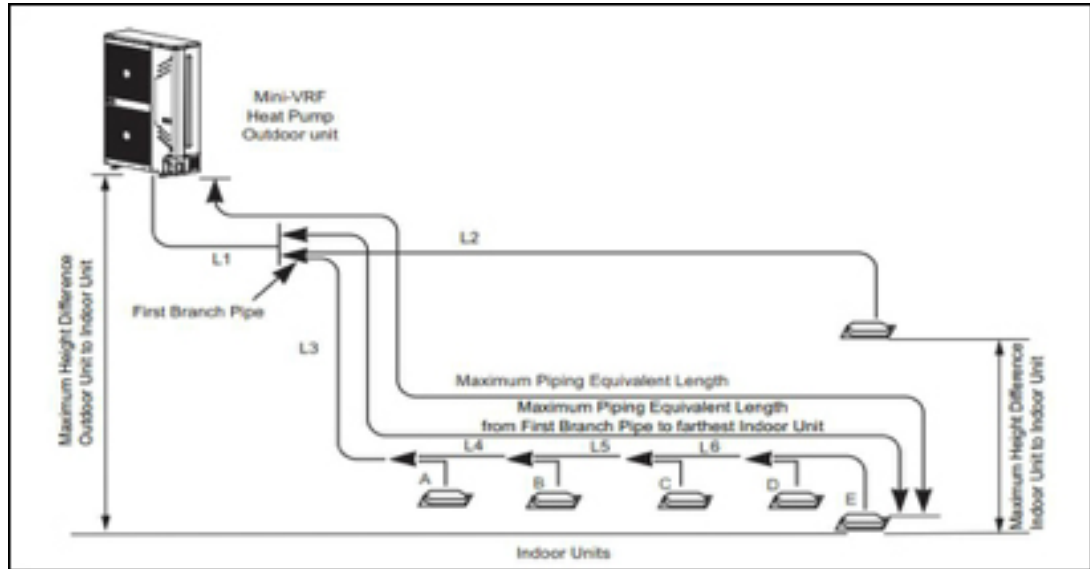

*Schematic of Multi-Zone Mini-VRF System*

Individual zones served by a single outdoor unit shall face the same orientation as all fan coil units can operate in either heating or cooling mode at any given time. Outdoor units should be located, preferably, on the roof of the building.

**.2 Variable Refrigerant Volume (VRV) / Variable Refrigerant Flow (VRF) Systems:**

VRV or VRF system uses refrigerant for transferring cooling or heating energy from the outdoor unit(s) to multiple indoor DX fan coil units.

Indoor units come in a variety of configurations: ductless wall mounted units, low-profile ducted fan coils, high capacity ducted fan coils, ceiling cassettes and floor mounted consoles. It can

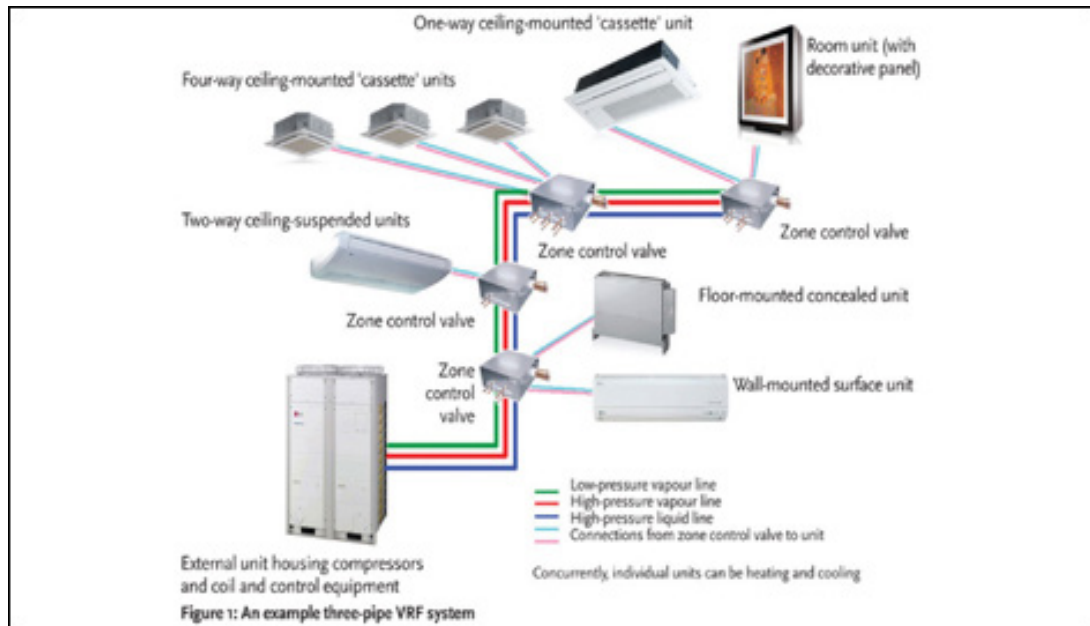

*Schematic of Three-Pipe Vrf System*

be used for any size building. Some manufacturers offer the low ambient option, which can be used in Northern Regions.

This system can come in a two or three-pipe configuration and as a heat pump version (all indoor units connected to the outside unit can operate in either the heating or cooling mode) or as a heat recovery version (indoor units can operate simultaneously in the heating or cooling mode).

In evaluating the VFV / VRF system for BC Housing projects, the heat pump version of this system should be considered. Ductless wall mounted indoor units are preferred, except for the larger apartments where low-profile fan coil units can be considered.

The VRV / VRF system will require a separate ventilation system as described in Sub-section 2.1.3. This would have to include a central or semi-central energy recovery ventilators or individual in-suite energy recovery ventilators.

VRV / VRF system requires a central proprietary control system and will require a specialized maintenance and servicing. It is a very energy efficient system but it may be cost prohibitive. It should also be avoided in the remote locations where specialized service is not available.

### .3 Two-Pipe Switchover Fan Coils

This system includes a boiler plant, air-cooled chiller (or optionally an air-cooled heat pump chiller) and either floor mounted vertical fan coil units or low-profile ceiling mounted fan coil units.

The two-pipe switchover hydronic distribution system is recommended over the four-pipe chilled water / hot water system (more typical for the market housing developments), to make it simpler, easier to maintain and less expensive. This will result in some temperature comfort issues during the shoulder seasons, but the lower cost and simplification of the hydronic piping distribution justify considering it for the social housing projects.

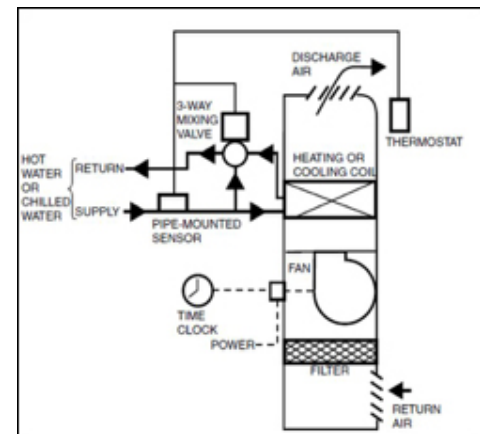

*Schematic Of Two-Pipe Vertical Fan Coil Unit*

In more moderate climates, the energy efficiency of this system can be increased by utilizing the air-cooled heat pump chiller, which can produce hot water for heating. In any case, the boiler plant shall be sized to provide a full backup capacity covering the peak heating demand of the building. As a centralized HVAC system, it can be considered for larger size buildings in any Climate Zone.

This HVAC system will require a separate ventilation system as described in Sub-section 2.1.3. This would have to include a central or semi-central energy recovery ventilators or individual in-suite energy recovery ventilators. Using the option of build-in ERVs integrated with vertical fan coil units, offered by some manufacturers, can also be considered.

### .4 Water Source Heat Pump System

This system includes reversible water-to-air heat pump units connected to a two-pipe condenser loop for heat rejection (in the cooling mode) or heat absorption (in the heating

mode). The central condenser loop is connected to the boiler plant (for adding heat to the loop) and to the outdoor closed-circuit fluid cooler (to reject heat from the loop).

Typically, residential water source heat pumps are floor mounted, vertical configuration units. Amenity / office areas can be served by horizontal ceiling mounted units.

This system allows moving energy through the condenser loop between the parts of the building requiring simultaneous heating and cooling. It also allows heat recovery, in the heating season, from heat pumps providing cooling of the electrical sub-station. The water source heat pump system has good energy efficiency and reasonable first cost. As a centralized HVAC system, it can be considered for larger size buildings in any Climate Zone.

This HVAC system will require a separate ventilation system as described in Sub-section 2.1.3. This would have to include a central or semi-central energy recovery ventilators or individual in-suite energy recovery ventilators.

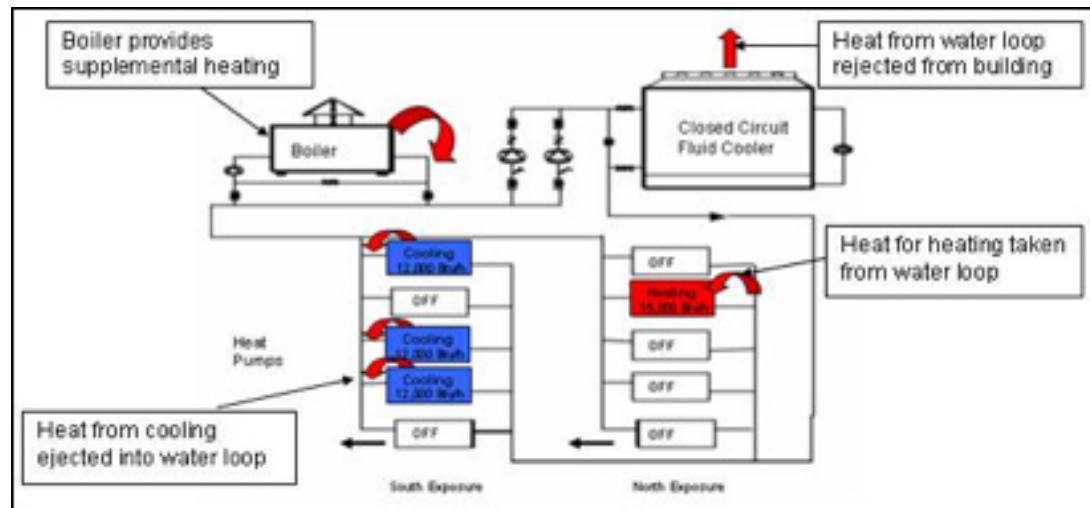

*Schematic of Water Source Heat Pump System*

## .5 Package Terminal Air Conditioner (Ptac):

PTACs are self-contained through-the-wall heating and air conditioning units (with optional ventilation accessory), which are a common choice for hotels and some residential buildings. They come in a variety of options, including a heat pump option with auxiliary electric heating to accommodate low ambient conditions in all Climate Zones.

PTACs are, generally, not recommended for the BC Housing projects due to a large sleeve opening through the wall, which compromises the envelope performance and due to excessive noise. The thermal bridging through the envelope combined with untreated ventilation air (mixed with return air) result, in most cases, in exceeding the energy efficiency targets.

PTACs can only be considered as an exception, evaluated on a project-by-project basis and approved by BC Housing. With no exceptions, this system, if considered, shall meet the BC Housing Energy Step Code requirements.

In evaluating the PTAC option, consideration should be given to choosing the premium units available on the market, which offer features addressing the energy performance requirements and sounds levels. Examples of such features include the patented ThermalGuard™ wall sleeve

design, which reduces heat transfer through a wall casing, offered by Ice Air or two round 150 mm openings for heat exchange, in lieu of a wall sleeve, offered by Aermec CMP unit. Units with better Energy Efficiency Rating (EER), better Sound Transmission Loss (STC) rating and better Outdoor Indoor Transmission Class (OITC) rating should be considered in evaluating the PTAC option.

The PTAC unit shall be a heat pump unit with an auxiliary electric heater for cold ambient conditions.

The ventilation option through the PTAC unit can only be considered if the unit can operate continuously with an acceptable noise level and if supplying untreated outdoor air through the unit meets the energy efficiency criteria. Otherwise, a separate ventilation system using ERVs should be provided (refer to Section 2.1.3).



*PTAC Unit*

**End of Section**

appendix

# D Modular Construction Methods



- ▶ Modular Design Requirements
- ▶ Modular Fabrication and Installation
- ▶ Finishes and Furnishing
- ▶ BC Housing Approval Process
- ▶ BC Housing Inspection and Commissioning

# 1 BACKGROUND

Prefabricated modular construction is an acceptable method of construction that BC Housing has considered for projects where the benefits of accelerated construction time, favorable working conditions, quality control and other site considerations are more suited to a project compared to conventional methods.

Appendix D covers general guidelines for the design, manufacture, transportation, storage and installation of prefabricated modular units used in projects that are funded or financed by BC Housing. The BC Housing Design Guidelines and Construction Standards is the base document which this Appendix forms part of and shall cover all other project requirements for the site and building design, client needs, materials and finishes, energy and sustainability, and building systems.

It is expected that this construction method results in a shorter construction period to deliver quality, permanent housing that is equivalent in service life to that of conventional stick frame buildings.

# 2 MODULAR DESIGN REQUIREMENTS

All work shall be designed and built to meet the requirements of the BC Building Code and Authorities Having Jurisdiction. All modules are to be designed, built, inspected, certified and labeled in accordance with CSA A277-“ Procedure for Certification of Prefabricated Buildings, Modules and Panels” and all applicable reference standards defined in CSA A277. The CSA A277 certification label and the specifications name plate shall be borne by each module at the time they are shipped to site.

An integrated design process shall be implemented at the early stages of the project and shall include builders, architects, installers, owners, and consultants to ensure proper coordination between factory-built and site-installed components to minimize changes in the field after the modules are in place.

## 1 GENERAL

**Climate Data:** For each location and building site identified by BC Housing/Owner, include in the specifications the code-compliant climatic data used to calculate design loads such as climate zone, heating degree days, moisture index, driving rain with pressure, hourly wind pressure, snow load, earthquake load and thermal comfort within the residential units.

**Structural Design:** Modules complexed together side-by-side and/or vertically stacked to form a multi-unit housing structure, for either permanent or temporary use. Ensure exact vertical and horizontal alignment of modules to ensure structural integrity of the building.

Confirm the form of modular construction (permanent or temporary) with BC Housing prior to overall building design, including selection of materials, and types of Mechanical, Electrical and Plumbing (MEP) systems used in the structure.

Design and fabricate with minimal construction and manufacturing waste. Supplier to track waste and recycling separately for the factory/manufacturing process and for the site/assembly process. Refer to BC Housing Waste Management targets and BC Housing Design Guidelines.

For structural steel assemblies, welders must be certified to CSA W47.1 “Certification of companies for fusion welding of steel.” The manufacturer must be certified to CSA A660 “Certification of Manufacturers of steel building systems.”

**Fire Resistive Construction:** Building modules shall incorporate any required fire resistive construction, smoke barriers and fire stopping. Plans shall include details for how fire related construction is accomplished across module mate lines (vertical and horizontal) with approved fire rated assembly listings.

**Mechanical, Electrical and Plumbing Systems:** Design MEP systems with simplicity, dependability, local serviceability and operating efficiency in mind. Using centralized high efficiency heat recovery units for ventilation is preferable when cooling in individual units are required as per ASHRAE 55 calculation for overheating. Packaged terminal air conditioner (PTAC) units can be accepted with prior BC Housing approval, but is not recommended due to noise, maintenance and envelope airtightness. Individual in-suite heat energy recovery ventilators (ERVs) can be installed with proper access for maintenance and servicing. ERVs shall be provided with Electronically Commutated Motors (ECMs) on supply and exhaust fans. Refer to BC Design Guidelines and Construction Standards, [Section 4, Division: 23 00 00 - HVAC](#) for heating and cooling design temperature, minimum ventilation rates and overall mechanical system design.

**Chases:** Modules shall incorporate vertical chases to accommodate MEP systems connecting from floor to floor. Align chases vertically to greatest extent possible. Allow sufficient space in floor and ceiling spaces for pipes and ducts. Minimum finished floor to ceiling height of 8'-0" shall be maintained throughout.

**Module-to-Module Connections:** locate and group crossovers in mechanical, closet, or plenum spaces if possible. Minimize system crossover points to greatest extent possible; locate and group crossovers in mechanical areas, closets, or plenum spaces when possible. Conceal MEP items accessible from tenant or occupant areas, locked or tamper-proof to prevent damage or unauthorized access.

Confirm with the building envelope consultant if the transport roof membrane between floors should remain after installation of the modules or be removed to prevent future water pooling between floors resulting from bathroom floods. If roof membranes are to remain consider providing ceiling hatches between floors to allow monitoring of possible future water build-up.

**Low Voltage Rough-in:** Provide back boxes, conduit, and cable management infrastructure in modular unit factory as needed for site-installed fire alarm, security, data, phone, cable television and similar items; these systems are typically wired with no junctions between devices and panels or termination points. Make provisions in unit design at factory for wiring installation without opening or damaging to finishes. Provide devices/outlets/jacks for phone, data and cable television as required, and wiring home runs back to the communication room demarcation point.

### Building Envelope

**Thermal Bridging:** Reduce or eliminate thermal bridging at individual modules and module-to-module joints to greatest extent possible including at additional framing or structural connections. Thermal bridging should be accounted for in the energy model. Follow Division 07 05 00- Thermal Bridging & Airtightness for further detail.

**Vapor and Air Barriers:** Provide details indicating continuity of building vapor and air barriers

for modules and across module-to-module joints on site. Air barrier shall be continuous and shall be identified as a single unbroken line illustrated on drawings including interfaces between dissimilar materials and parts. All buildings will need to be tested to determine Envelope Air Leakage Rates as airtightness of the building envelope is critical to its performance. Refer to [Section 2: Energy and Environmental Design](#) for building performance targets and airtightness testing requirements.

Design considerations may vary depending on whether the project is permanent or temporary. This will be confirmed by BC Housing.

**Transportation and Module Protection:** Transportation shall comply with the requirements of current editions of the provincial or local codes, regulations, bylaws or authorities having jurisdiction.

Fully protect modules from weather, moisture, materials, substances and other conditions during transportation, handling and storage that might damage or cause accumulation of moisture, any mold or mildew growth affect building performance. Weatherproof modules in the factory. Wrap all six sides with at least a weather-resistive barrier.

Secure all appliances, wall, roof and overhangs during transportation to avoid displacement and movement from vibration and road shock.

All modules shall be free from

- mold, mildew or other deleterious substances
- damage from moisture, leaks or water penetration
- structural or any damage due to transportation or handling

Materials that have evidence of growth of molds or mildew are not acceptable, including both stored and installed materials; immediately remove from site and dispose appropriately.

## 2 TEMPORARY MODULAR PROJECTS

Where specifically required by BC Housing, a project may be located temporarily on a site. Design temporary modular projects to meet the construction requirements and standards of Authorities Having Jurisdiction and BC Housing, and to have the resiliency and durability to be moved and relocated a minimum of 3 times over the expected life of the building. Design modules to minimize time and materials needed each time the building is moved.

- .1 Module Design:** Incorporate a planed gap or “growth allowance” between adjacent modules, sufficient to allow for site adjustment to accommodate variances in foundations or module dimensions, and including subsequent installations. Provide appropriately sized wooden sleepers between vertically stacked modules to lifting crane straps between modules for lifting modules during relocation. Use of cutaway areas or components that would prevent or hinder transporting or relocating of modules are not permitted. Do not use site-built components.
- .2 Structural Connections:** Use bolts, removable pins, or screws; permanent or one-time use connections (eg: welding) for securing module to module, or module to foundation is not permitted.
- .3 Exterior Trim at Module Joints:** Use removable trim, siding panels and similar items at module joints or intersections designed to allow access to structural connections without disrupting adjacent siding or cladding.

- .4 Interior Trim:** Consider painted wood trim or other architectural feature at interior wall and ceiling joints between modules designed to permit removal and separation of the modules without damage to adjacent materials and finishes.
- .5 Resilient Tile or Strip Flooring:** Where permitted by BC Housing Design Guidelines and Construction Standards, resilient vinyl tile or strip flooring may be used at the module joint for disassembly; provide additional matching flooring of same specification as adjacent flooring for one module relocation.
- .6 Roofing:** Design roof system with curbs or other features at the module joints as required to allow for the roof to be cut or otherwise disconnected for relocation. Provide sufficient slope, crickets and drainage to prevent water from running over curbs. Roof must be capable of keeping water out of structure during the relocation process or with provisions for a temporary roof or cover to be used during transportation. RCABC 5 years roofing warranty may be considered (prior BC Housing approval) in lieu of BC Housing standard 10 years roofing warranty. Acceptable roofing system shall be as outlined in Division 07 50 00 Membrane Roofing.
- .7 Mechanical, Electrical and Plumbing Systems:** Design systems with plug and play features to greatest extent possible, at module joints (eg: quick-connect fittings, access panels and similar items) to minimize labour and materials required when relocating units.
- .8 Foundation and Site:** Consider future building relocation and site restoration when creating a foundation design. Use components that are suited for easy removal and possible re-use when building is to be relocated (eg. screw piles or pre-cast concrete pads and blocks at interior supports). Minimize depth and quantity of soil excavation to reduce waste, trucking costs, and site disruption when building is removed; allow for resulting increase in floor to grade height, and resulting in additional steps and longer access ramps. Provide on-grade foundation and use manufactured pre-treated wood or metal stair and ramp systems, adjustable, easily re-used and relocated, solid and secure, and be compliant with accessibility requirements.

Provide a detailed de-assemble instruction package for each modules and module to module as part of the close-out submittals to BC Housing/Owner.

### 3 PERMANENT STRUCTURES

Design permanent structures for one-time installation, to remain at project location for their expected life. Design structure to include concealing the appearance of modular construction to greatest extent possible. Unless otherwise specified by BC Housing or Owner, the structure shall be designed and built as permanent structure.

- .1 Module Design:** Modules may contain elements or sections of the structure required for transport that are later cut out or removed after the modules are lifted into place. Panelized wall sections may also be utilized in areas of the building not conducive to standard modules.
- .2 Structural Connections:** Design structural connections to efficiently transfer loads without the need to be conveniently separated for transport and re-use as in temporary structures.
- .3 Exterior Trim:** Provide siding materials and trim at module joints to greatest to create a homogenous appearance to façade and reduce possibility of heat gain/loss thru module joints; where not possible use other acceptable method. Sealing gaps and voids between modules

with insulation, expanding foam, or compressible gaskets, and with moisture/vapor/air barrier construction.

- .4 Interior Trim:** consider holdback of interior wall and ceiling cladding with site installed infill after modules are set in place or other means of fully concealing module wall and ceiling joints.
- .5 Roofing:** Roofing system shall be designed with as few seams and joints as possible. Simple slopes with as few curbs, crickets, etc. as possible to create a low maintenance roof. For acceptable roofing membrane and warranty requirements, refer to Division 07 50 00 Membrane Roofing.
- .6 Foundation and Site:** For permanent modular projects, use standard concrete stem wall and footing foundation with sufficient crawl space for access and service. Crawl space design shall be insulated, vented, heated and protected from moisture in accordance to code and required energy target for the project. Radon mitigation measures must also be provided where required by code. Interior support and bearing points may be isolated footings with post and beams, or strip footings with wood framed pony walls. Unless otherwise specified, design foundation based on lowest finish floor height to grade possible, while maintaining minimum clearances to wood framing and siding materials as required by Building Code and the AHJ. Minimize number of steps and ramp length to enter structure. Steps and ramps may be constructed of poured in place concrete to reduce future maintenance needed. The project must be designed and planned to ensure that finish grades will slope away from the building.

Refer to BC Housing Design Guidelines and Construction Standards, [Section 4: Construction Standards](#) for material and equipment selection and detail specifications. Any substitution or alternatives to BC Housing Design Guidelines must be pre-approved by BC Housing/Owner prior submitting the tender price. Refer to [Division 01 23 00 - Alternatives](#).

## 3 MODULAR FABRICATION AND INSTALLATION

- .1** Factory fabricate modular units in a factory designed for the assembly of modular structures. Complete each module to greatest extent possible, including; interior and exterior finishes, MEP systems, casework and fixtures, prior to shipping.
- .2** The following items can be installed or finished on project site:
  - .1** Furnishing and equipment.
  - .2** Chimneys and flues.
  - .3** Foundations and anchors.
  - .4** Connection between units.
  - .5** Connections to existing or temporary utility services.
  - .6** Shared corridors/stairs/circulation paths between units.
- .3** Modular manufacturer to maintain and adhere to a documented quality control program. At a minimum, manufacturer shall conduct QC inspections of the individual modules at the following points in construction; framing, rough-in of MEP, and final ready for shipping. Document any

discrepancies found and their resolution for each module. Provide a written QC report to the owner along with any third-party inspection agency documentation. Reports to be provided with closing documentation unless requested otherwise. Allow for training, mock-ups, and performance testing of modules in the factory prior to proceeding with full factory mobilization.

- .4 Deliver each module unit to project site or a secure staging area. Secure loose materials to prevent damage. Protect modules from damage from inclement weather and during transportation, handling and storage. Inspect modules frequently for damage and defects affecting performance. Refer to [Article A.1 under Transportation and Module Protection](#). Repair or replace defective items immediately. Store modules off ground on suitable supports with undersides sealed against intrusion by insects and rodents.
- .5 Mark units to be craned with lifting strap locations, or provide a lifting manual with locations for lifting straps.
- .6 Provide tags, marks, or other means to identify concealed mechanical, electrical, or plumbing connections or crossovers on each module, readily locatable by installers at project site, and to prevent damage due to water leaks from unconnected pipes or damage from exploratory holes cut after modules in place.
- .7 At end of each work day during installation of modules, secure building from weather damage or intrusion. Plan on providing a moveable temporary roof structure that can be removed and reinstalled after each floor of modules is installed.
- .8 Develop a field QAQC plan that includes field review from an experienced building envelope consultant to verify that the joints between walls, foundation, floors and ceilings and module-to-module as well as the overall building envelope including exterior siding and roof have been sealed as required.

A field report from the the building envelope consultant is required at 50% site installation and substantial completion.

The moisture content of the building component shall not exceed 19%. BC Housing may request a testing report summary prior installing the siding and roof.

- .9 All building materials and components shall be free of any damage, deficiency and any evidence of molds and mildew. All defects and deficiency shall be corrected prior to occupancy.

## 4 FINISHES AND FURNISHING

The design and choice of materials, building systems and finishes should emphasize durability, sustainability, local availability and serviceability as well as the target residents for the ease of maintenance and minimize long term operating costs for the Operator. For factory finished or other materials that are likely to require replacement rather than repair and refinishing, select from those materials that are a standard finish or pattern, that is more likely to be readily available and a close match with remaining materials when replacement is needed in the future. Where vinyl-clad drywall is specified for a project, provide the Owner with replacement materials equivalent to 5% of the quantities provided for the project.

If required by BC Housing/Owner and specified in Owner's project requirements, the furniture inside the suites, common dining room, common lounge and offices may be provided by the modular builder. Request a furniture list and specifications from BC Housing/Owner if this shall be part of the contract pricing.

## 5 BC HOUSING APPROVAL PROCESS

Provide specifications and drawings at schematic design stage, design development stage, 50% and 98% construction document stage for approval by BC Housing. Consult with BC Housing prior submitting to development permit and building permit to local municipality. The submittal requirements shall follow Section 5: Drawing and Document Requirements. All closeout and O&M requirements shall follow Division 01 78 00 Closeout Submittals. In addition, for temporary modular projects, provide a Relocation Manual to BC Housing which includes; detailed instructions for disassembly of modules and re-assembly on new site. Manual shall include the following information at a minimum:

- Drawings, details and photographs clearly indicating locations of module structural connections, trim and other materials requiring removal to separate modules.
- Temporary bracing, straps, or supports to be installed prior to craning or shipping modules.
- Location of mechanical, electrical, or plumbing crossovers and connections requiring separating or disconnecting.
- Weights of each module and separate components (i.e. HVAC equipment) requiring lifting by crane.

## 6 BC HOUSING INSPECTION AND COMMISSIONING

The contractor shall ensure that all building systems and integration of the systems are properly commissioned and operating and functioning as intended in the contract documents. The consultant team ensures that the contract documents are in accordance with the Owner's project requirements, meet BC Housing Design Guidelines and other project specific requirements, building code, by-law requirements and authorities having jurisdiction, and outlining the commissioning requirements and process for all building systems and integration of the systems. The contractor is ultimately responsible for ensuring that all building systems and integration of the systems are operating and functioning as intended in the contract documents. At a minimum, the contractor is required to hire an independent testing and balancing (TAB) agency for mechanical systems regardless of project size and the report shall be shared with BC Housing.

The commissioning of the modular projects shall follow the commissioning requirements as outlined in [BC Housing Building Commissioning Guidelines](#) and BC Housing Design and Construction Standards [Section 4 Division 01 91 00 Building Commissioning](#) depending on the project size. Upon completion of each modules at the factory and ready to transport at site, the contractor shall ensure that the signed plumbing, electrical, and gas test forms, all 3rd party balancing and testing reports including HVAC, plumbing, fire protection systems, and signed copy of the CSA A277 certification label and the specification nameplate applied on the module. The contractor performs the pre-functional tests, manufacturer static verification, and functional testing, provide Owner's demonstration/training and submits the completed reports at or before substantial completion as outlined in BC Housing Commissioning Guidelines.

BC Housing may retain a 3<sup>rd</sup> party independent inspector to inspect the factory installation, on-site work progress and conduct commissioning activities (such as overseeing pre-functional testing, functional testing, owner's demonstration) during the construction and at completion stage. Refer to [BC Housing Building Commissioning Guidelines](#).

End of Section